

Examples

Esempi

Ejemplos

4.0

Window details
Door details
Details, structural connections
Wall connections

Sezioni finestre
Sezioni porte
Dettagli di costruzione
Attacchi a muro

Detalles de ventanas
Detalles de puertas
Detalles de construcción
Cierres constructivos

4.1
4.2
4.3
4.4

Window details

Sezioni finestre

Detalles de ventanas

4.1

Legend

+ = Fixed
— = Open in
- - - = Open out
Dimensions in: mm
Scale 1:1 - 1:2

Legenda

+ = Anta fissa
— = Apertura interna
- - - = Apertura esterna
Misure in: mm
Scala 1:1 - 1:2

Leyenda

+ = Fijo
— = Apertura interna
- - - = Apertura externa
Medidas en: mm
Escala 1:1 - 1:2

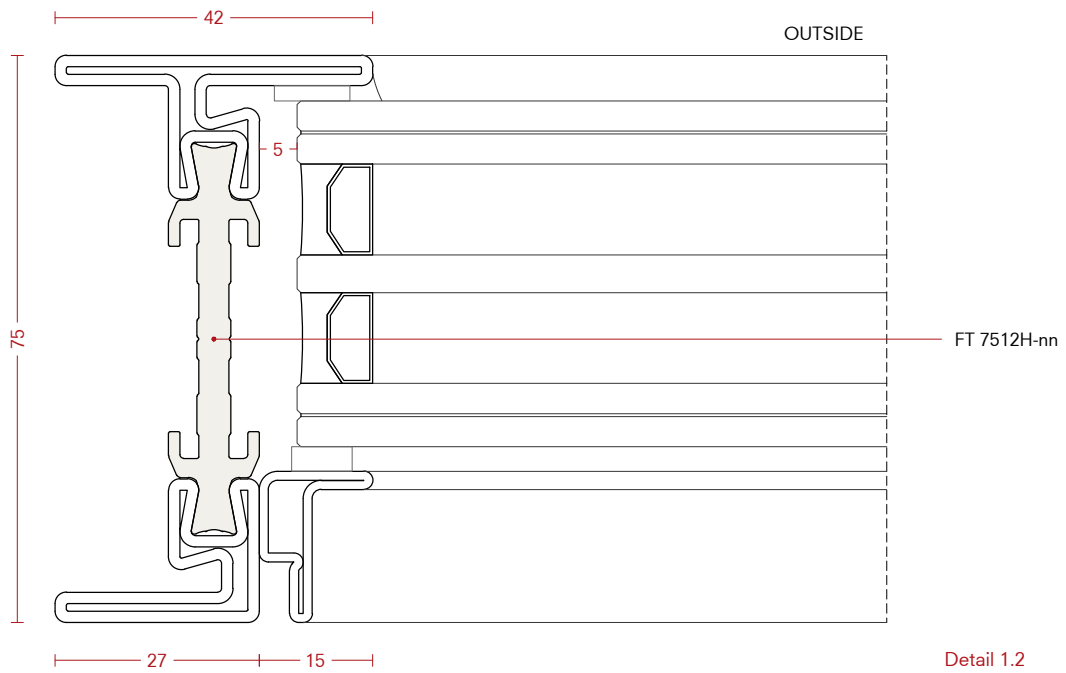
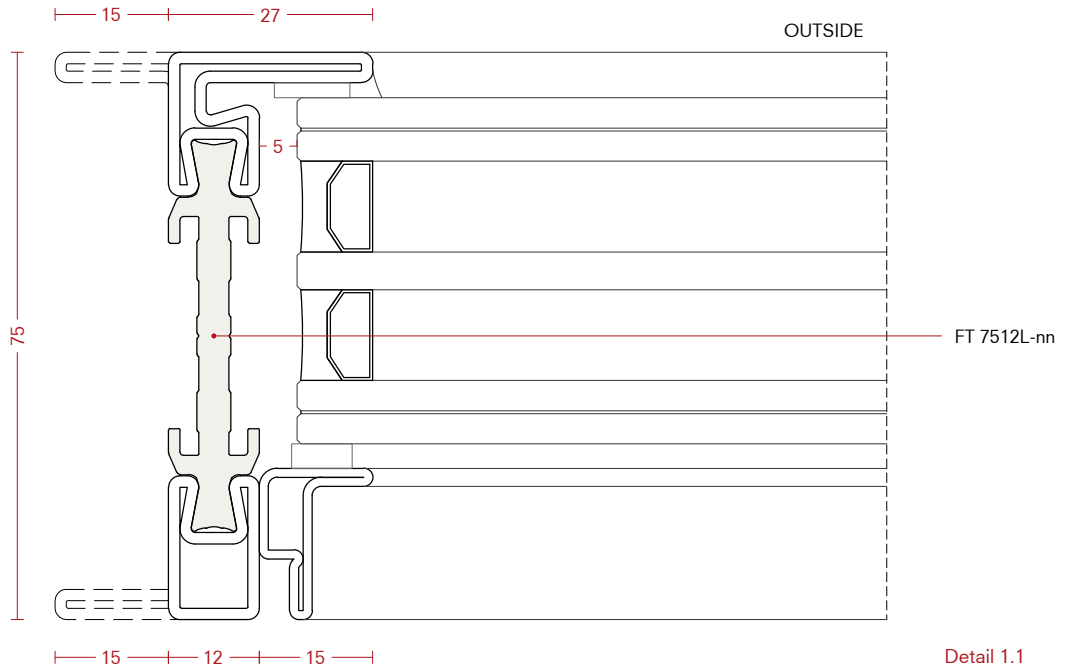
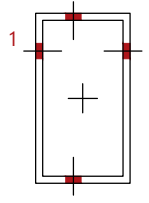

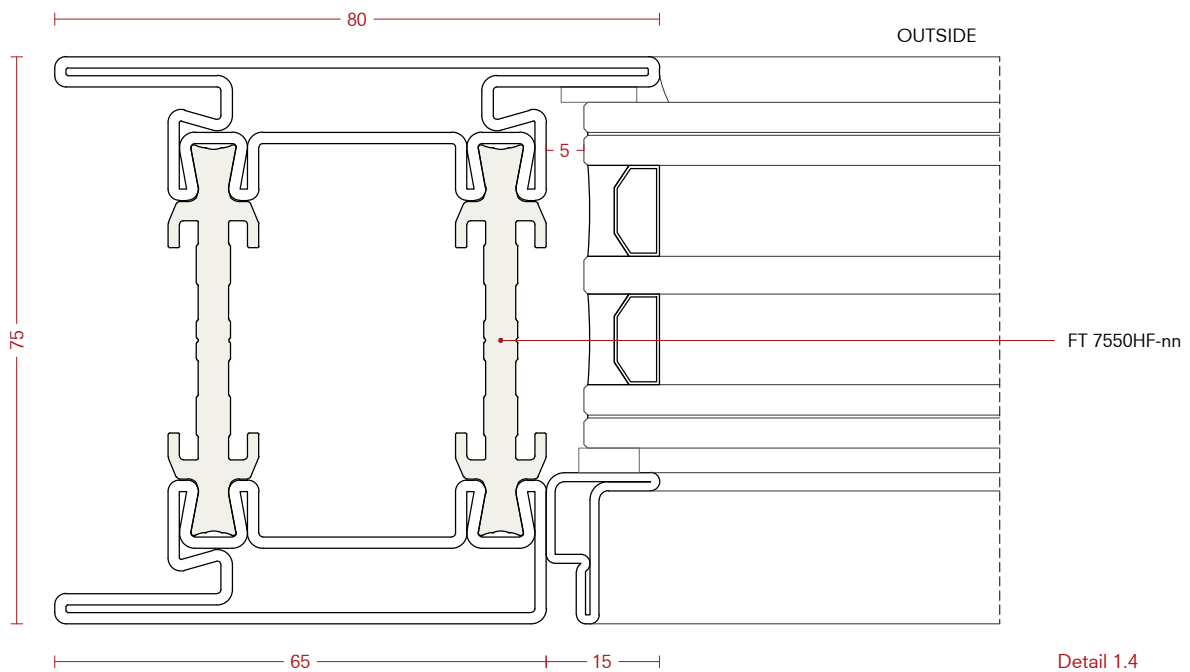
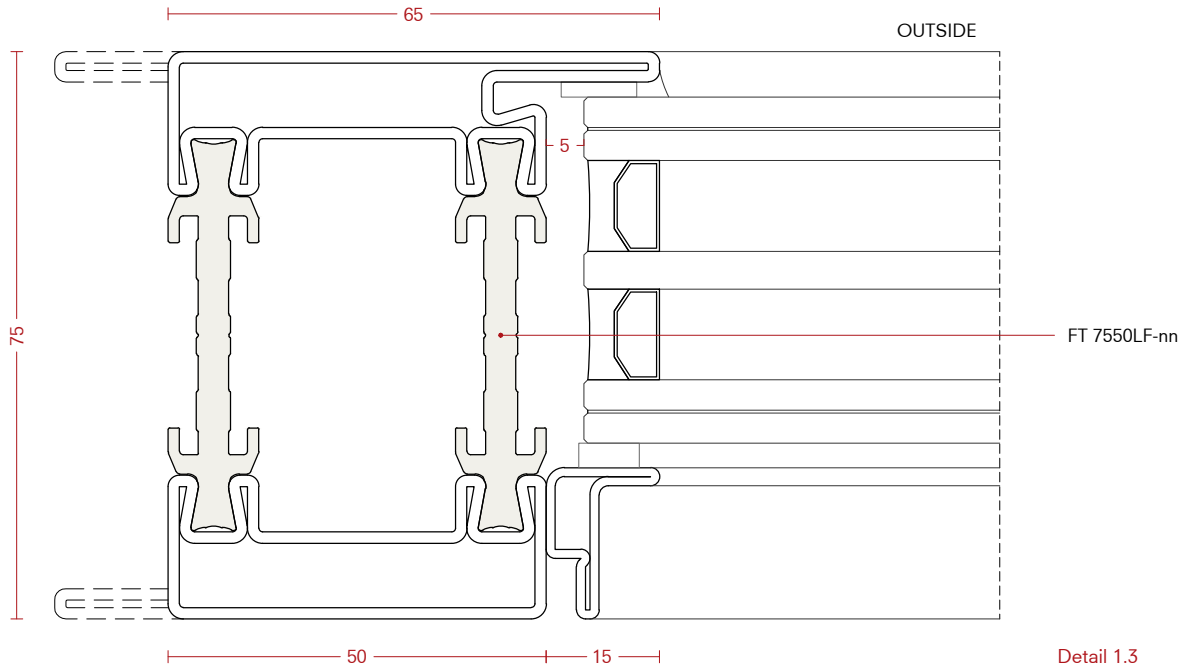
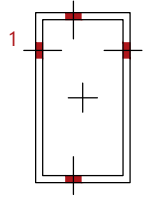

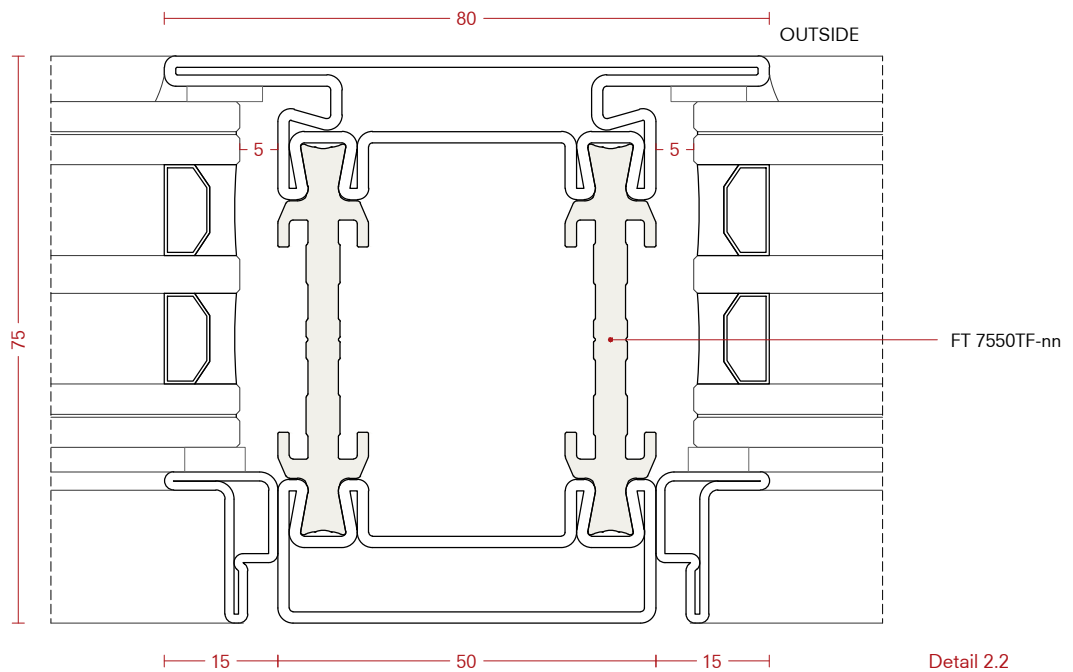
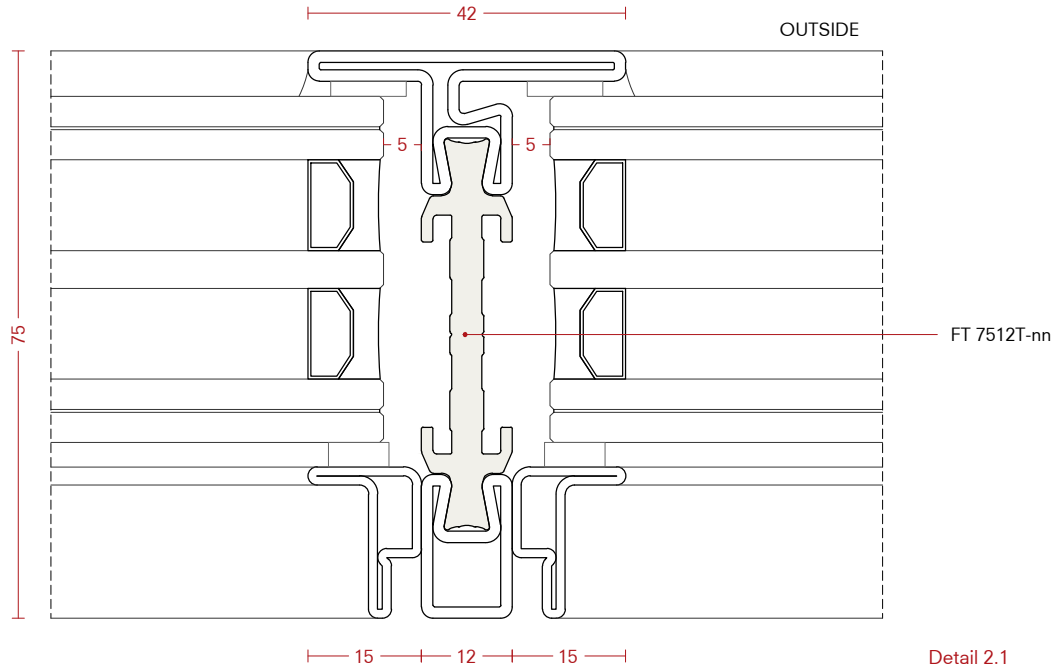
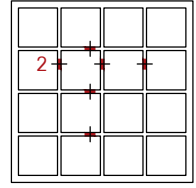

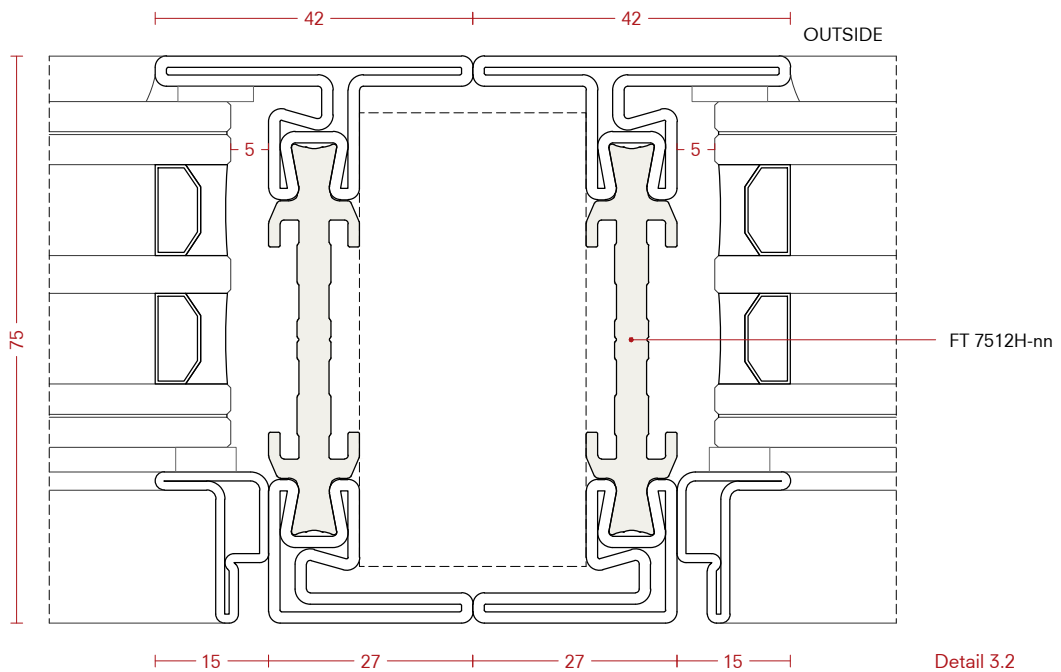
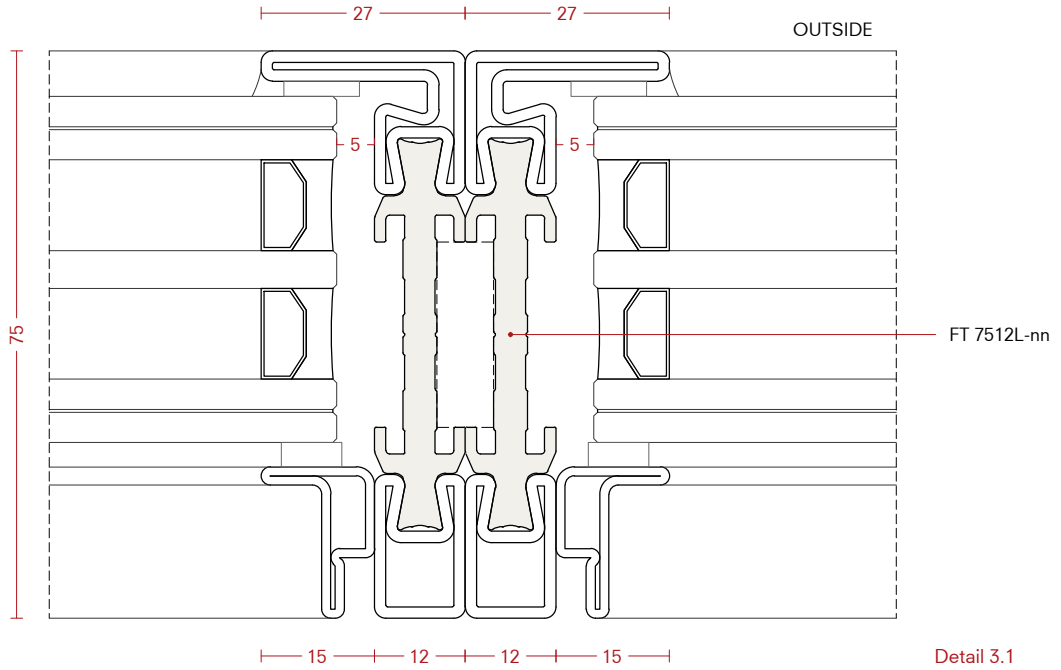
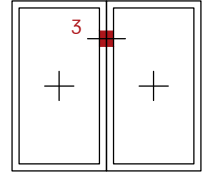

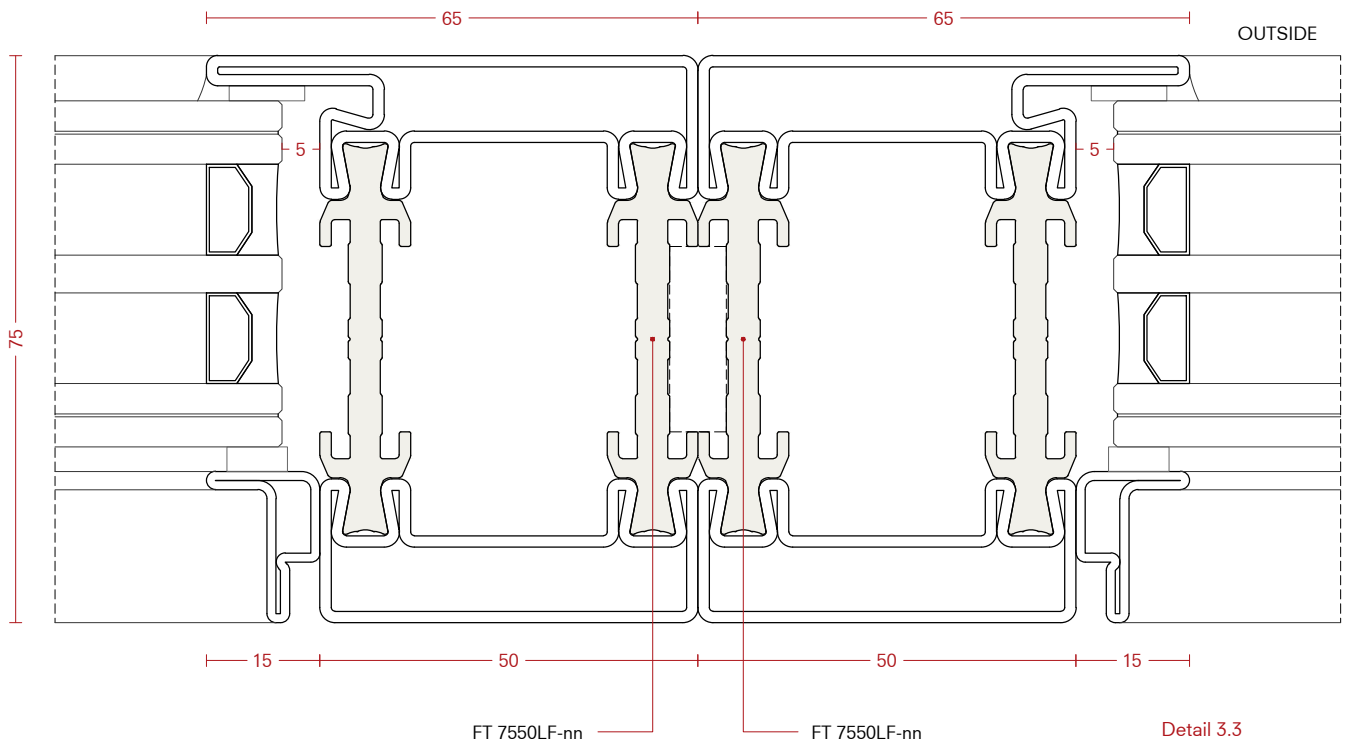
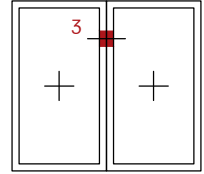

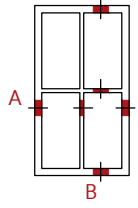

A

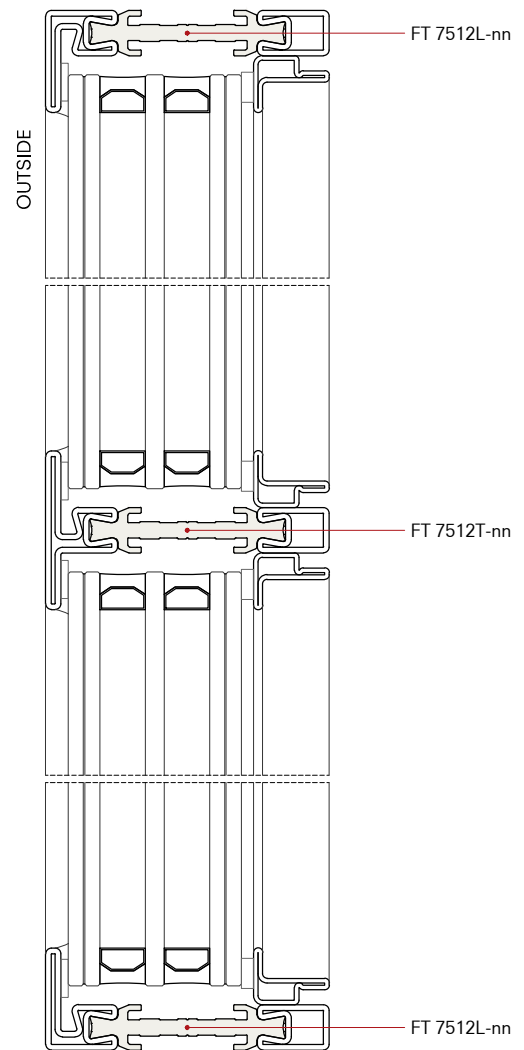
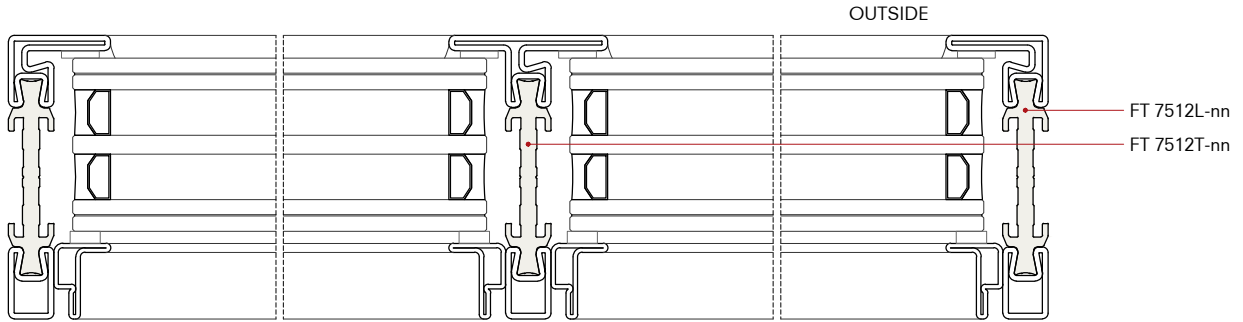

B

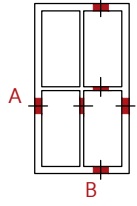

A

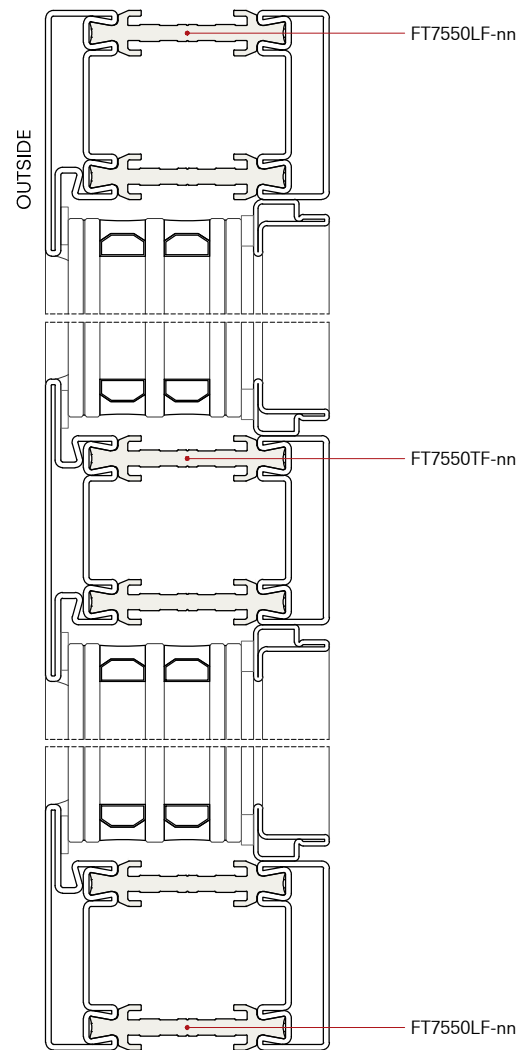
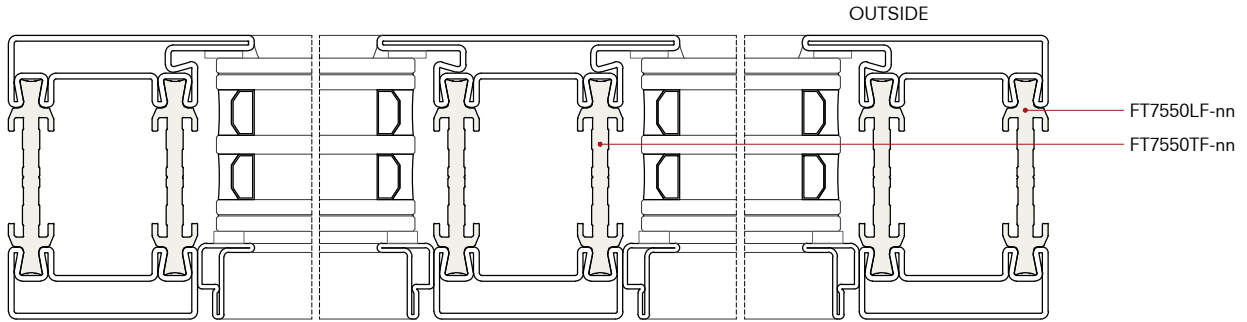

B

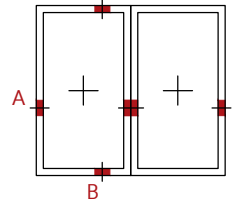

A

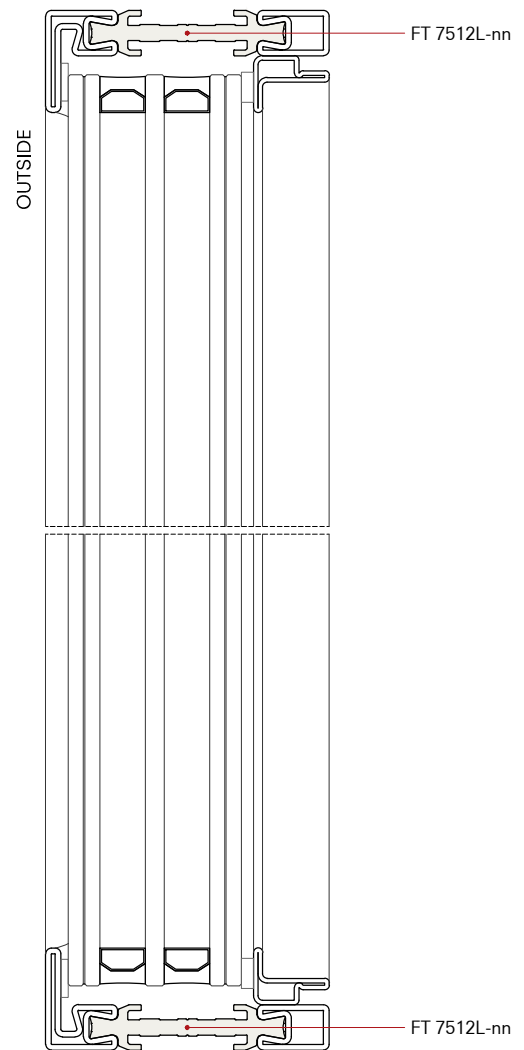
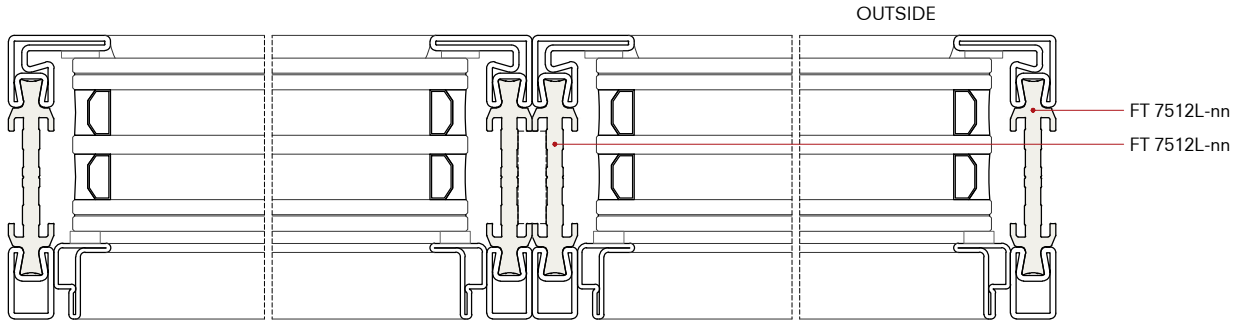

B

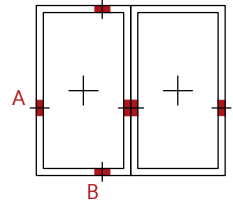

A

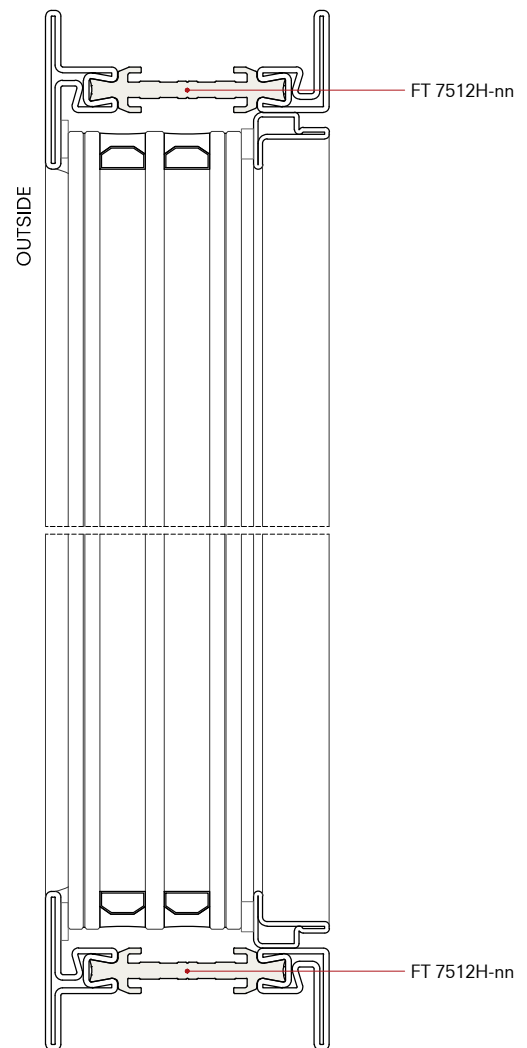
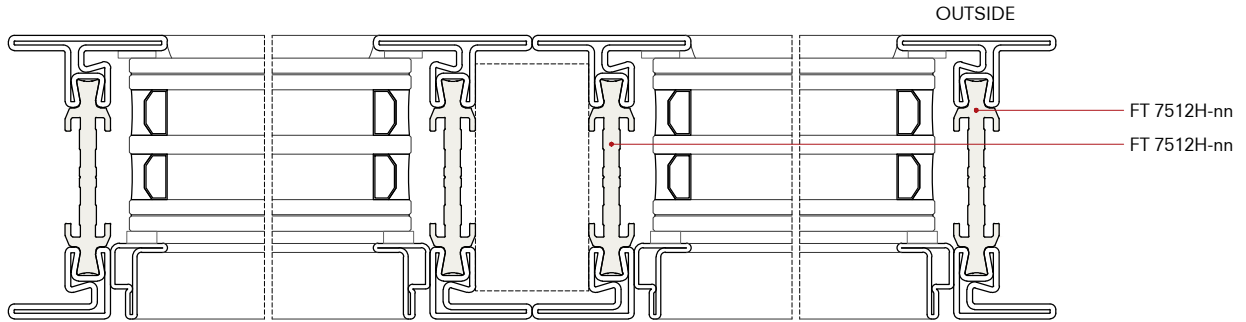

B

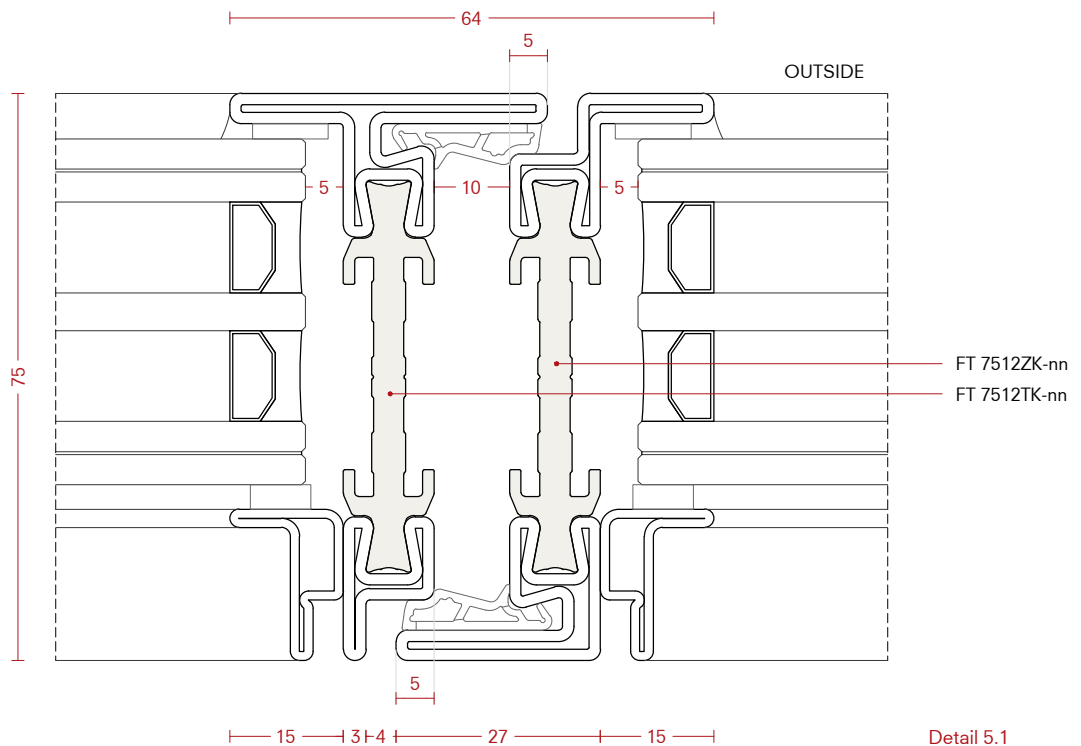
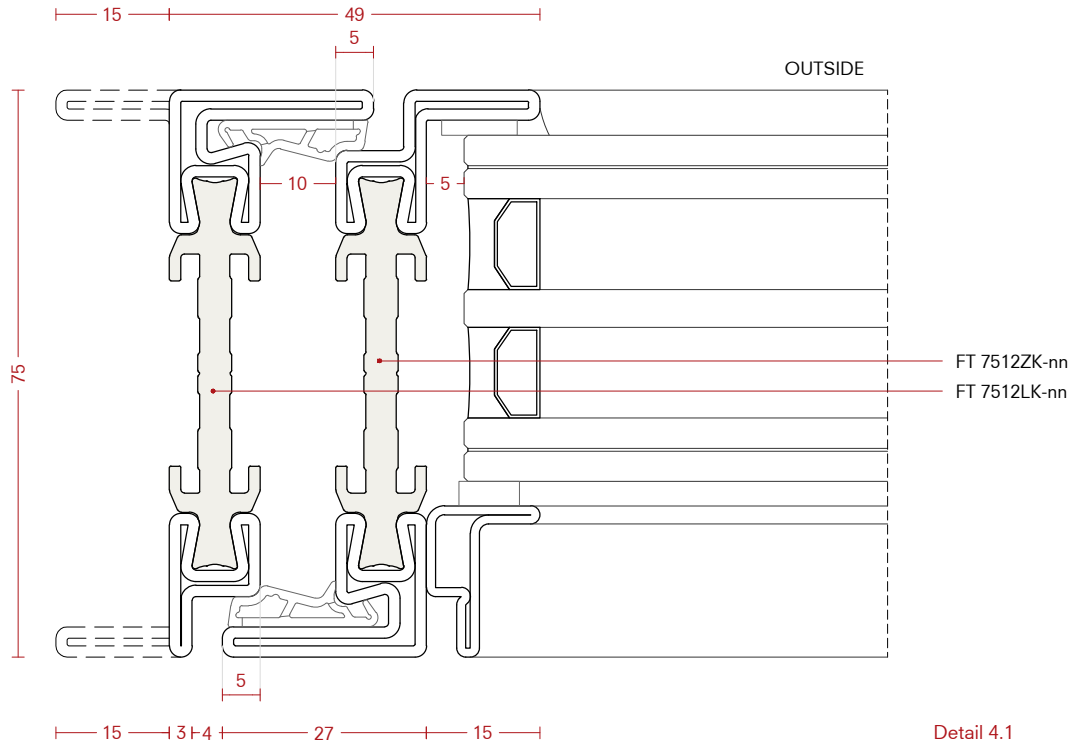
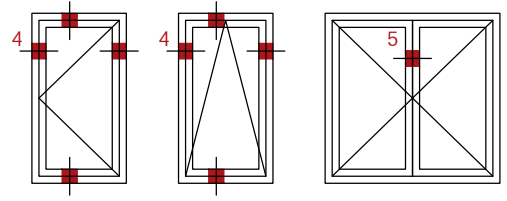

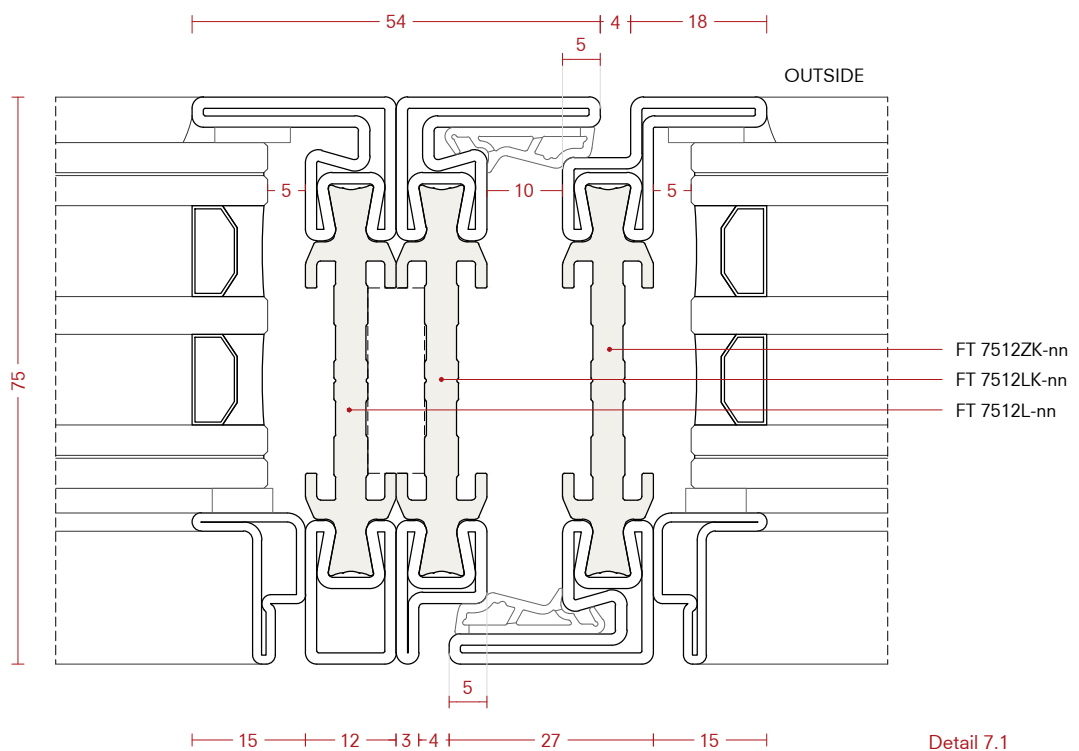
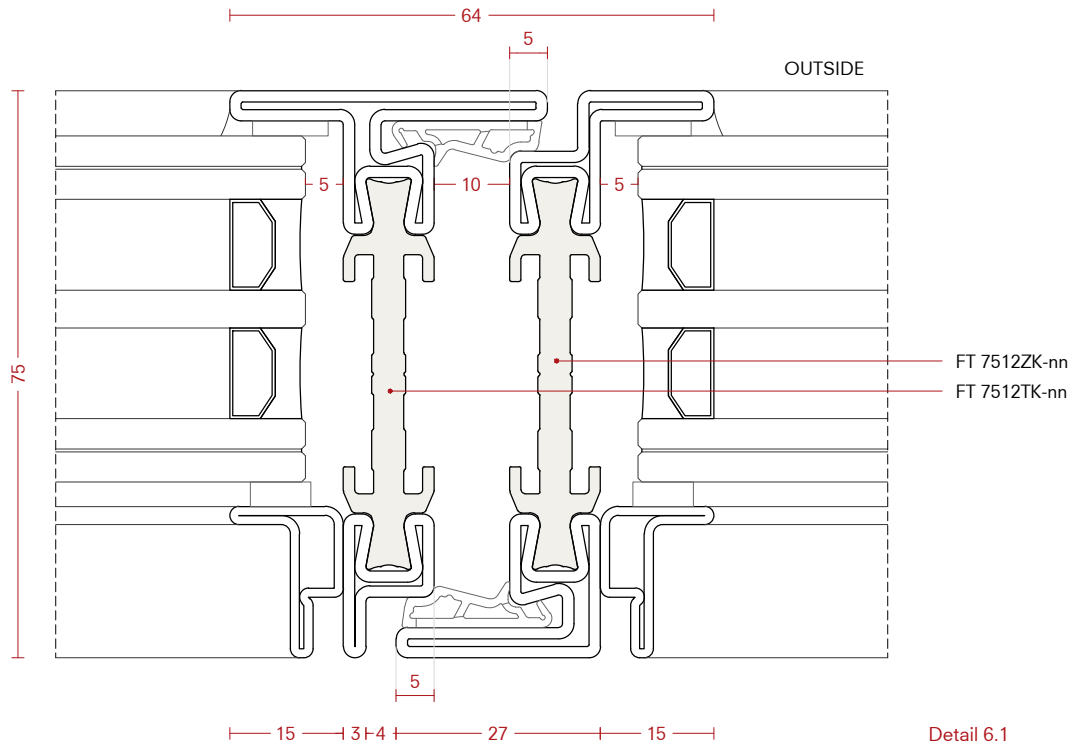
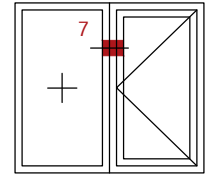
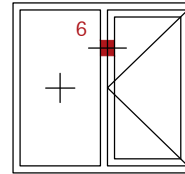

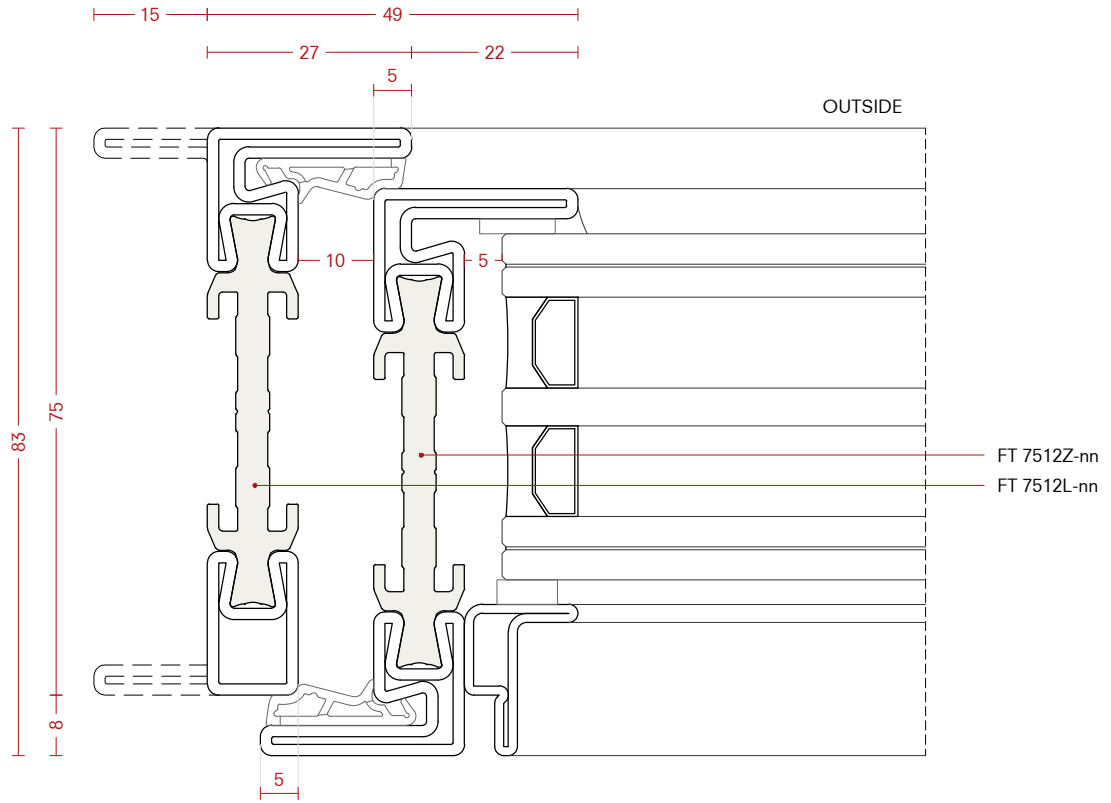
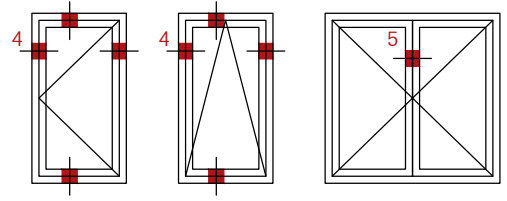

Detail 4.2

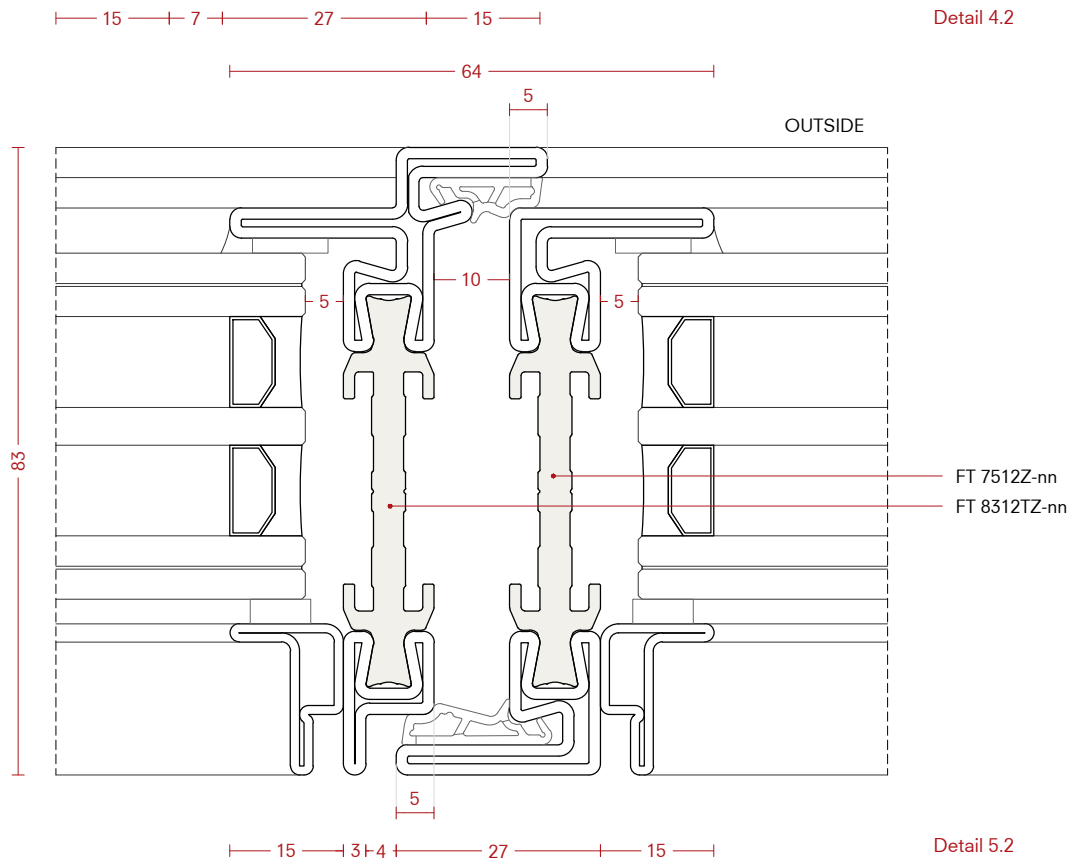

Detail 5.2

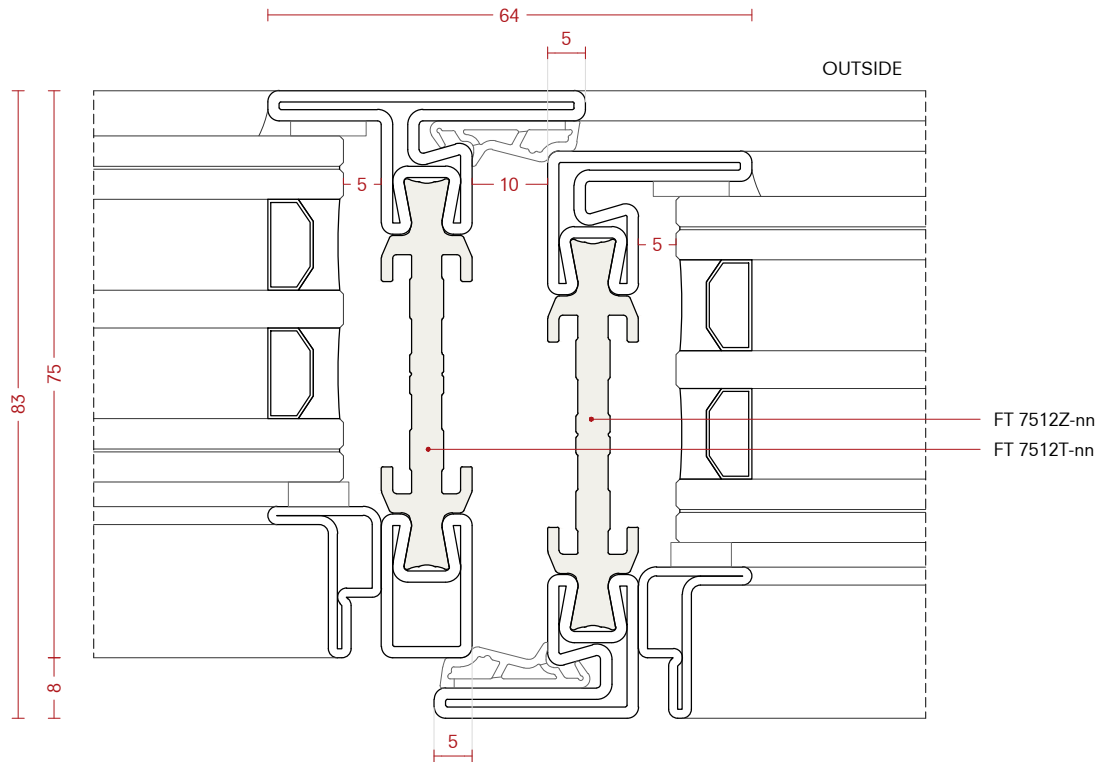
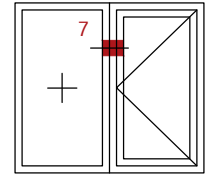
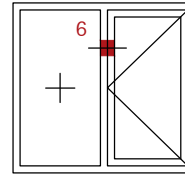

Detail 6.2

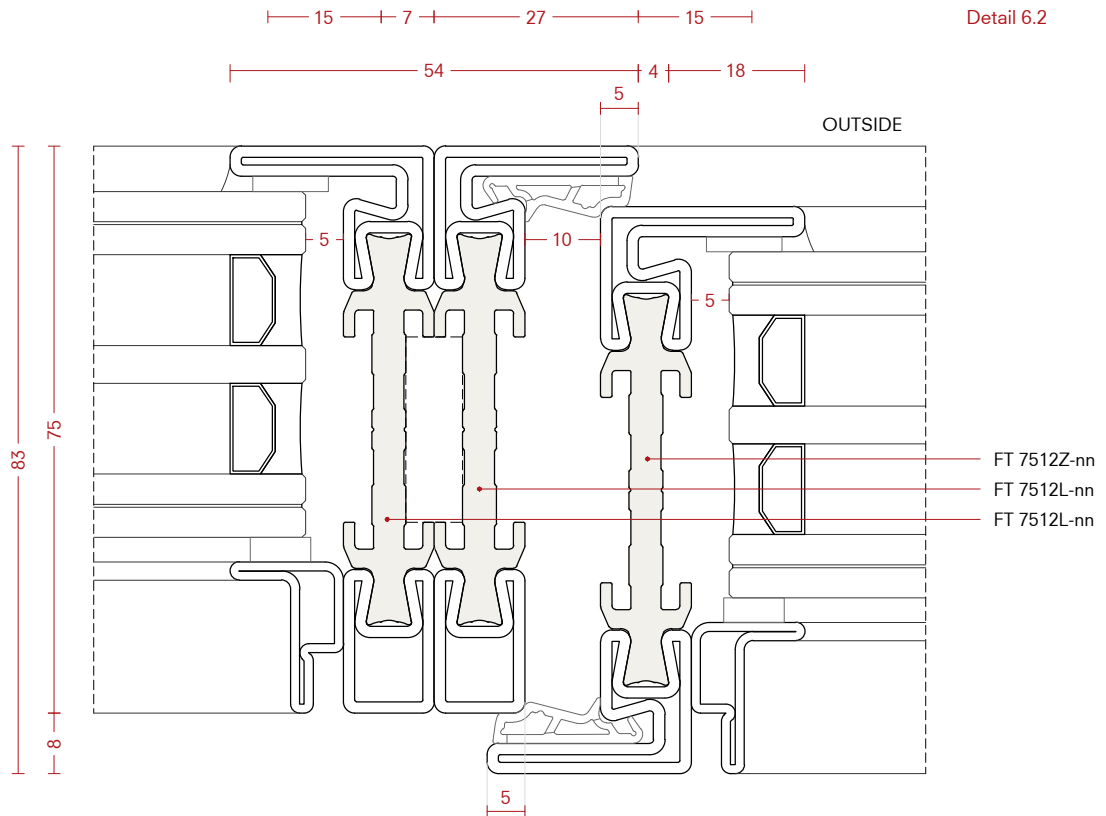

Detail 7.2

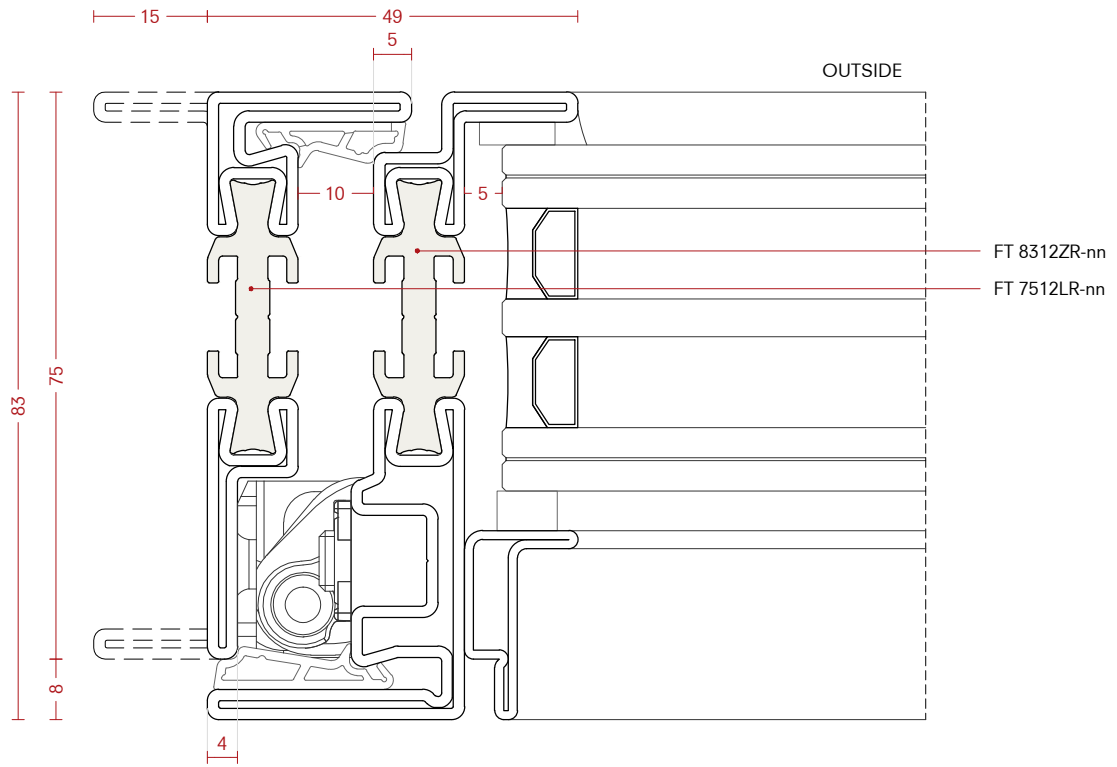
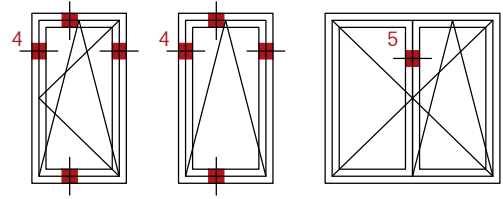

Detail 4.3

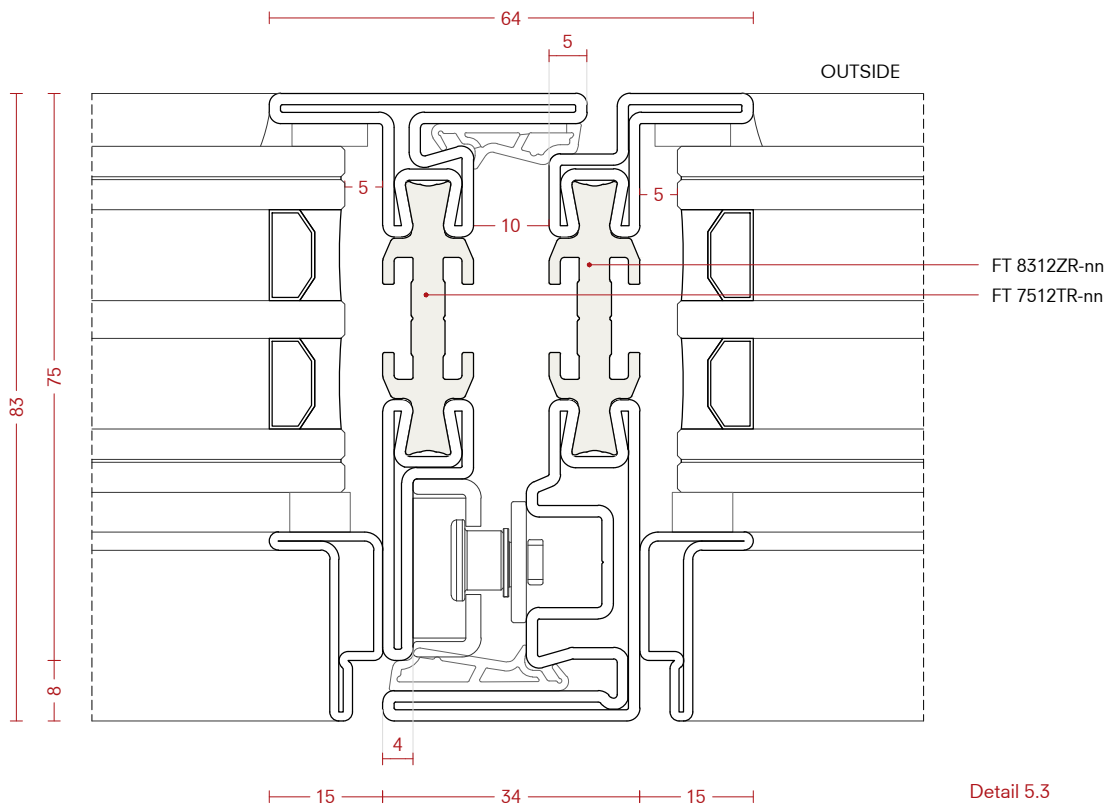

Detail 5.3

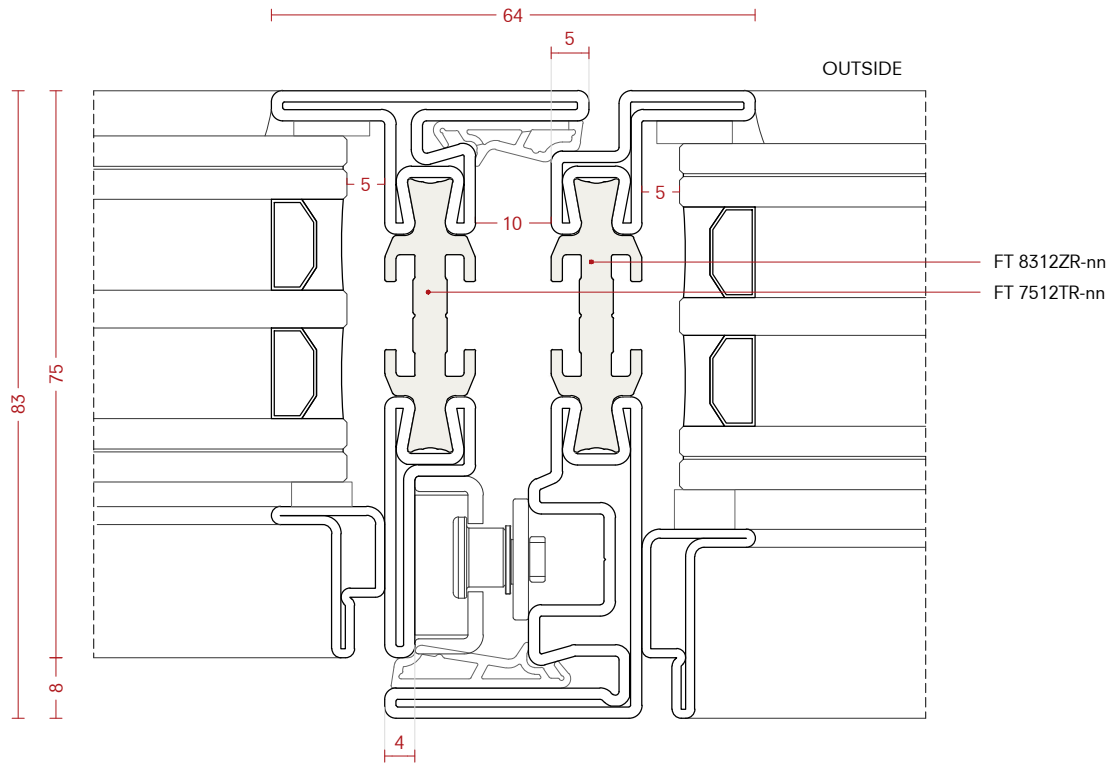
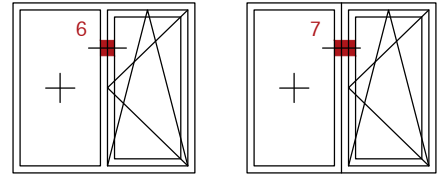

Detail 6.3

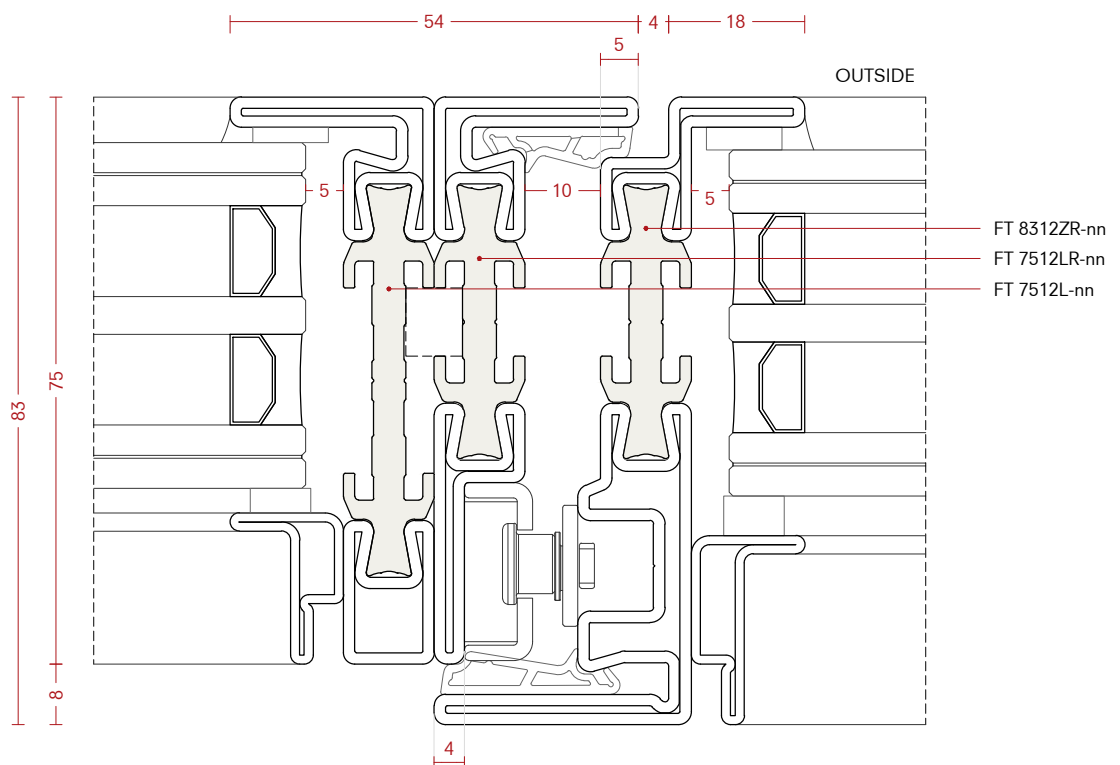

Detail 7.3

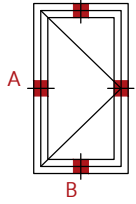

A

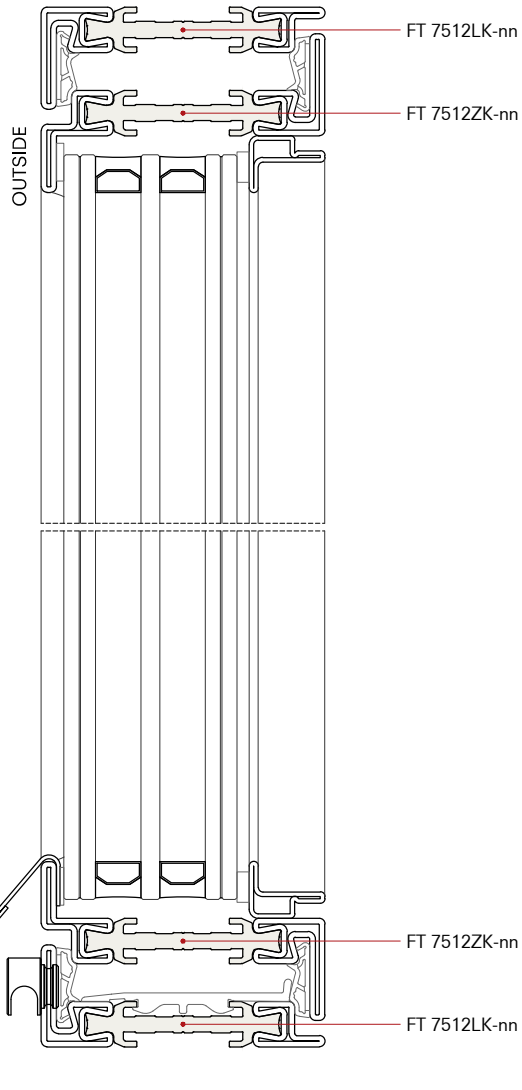
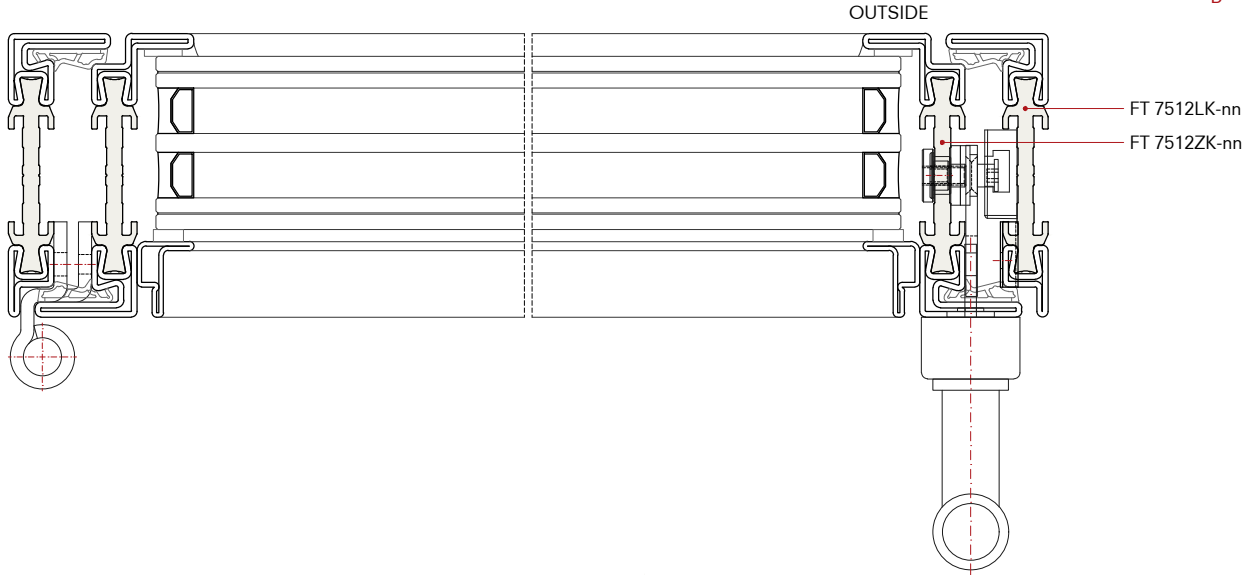

B

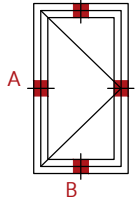

A

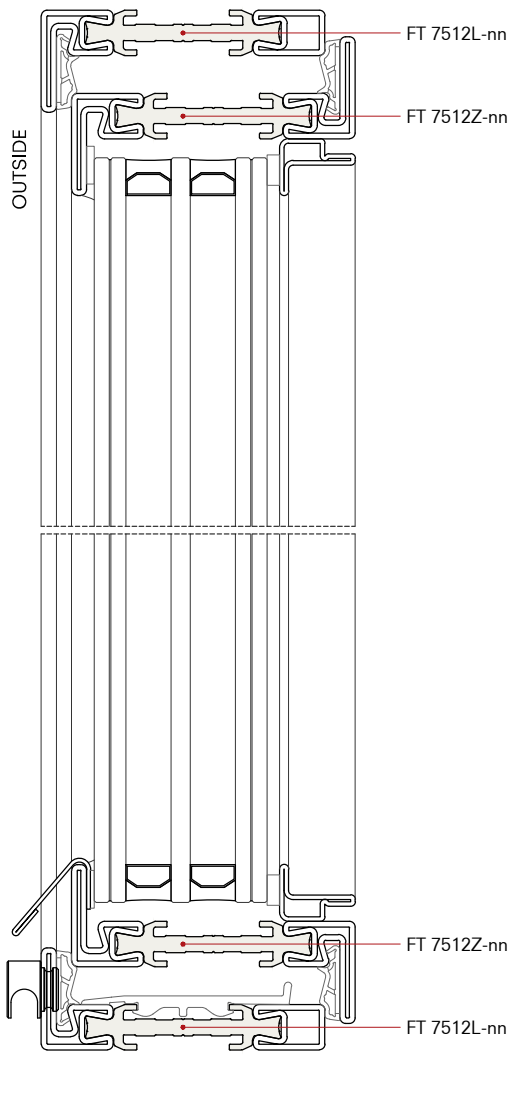
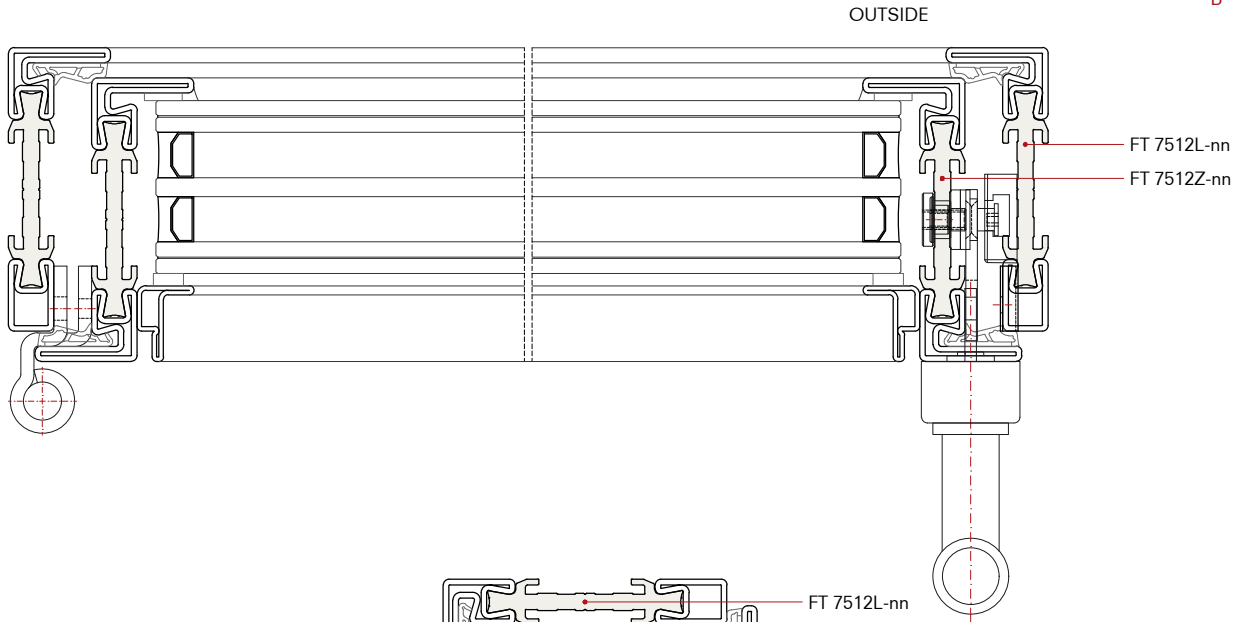

B

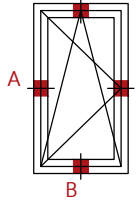

A

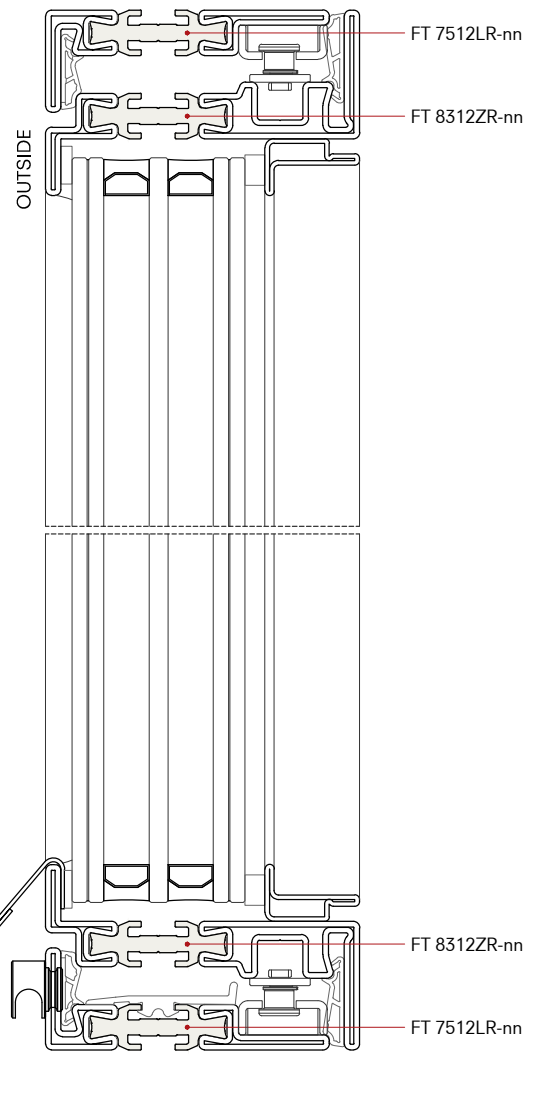
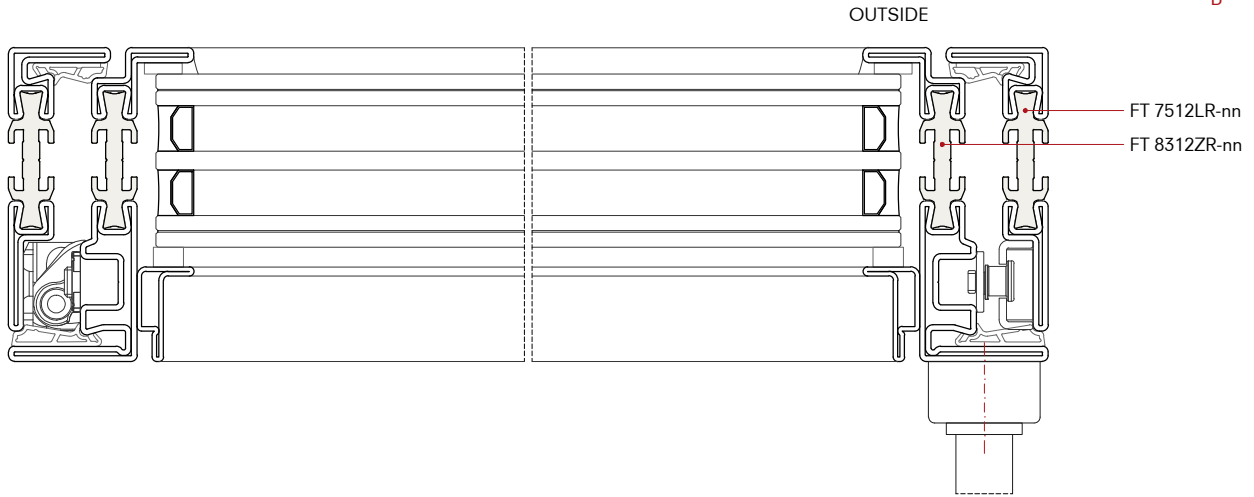

A

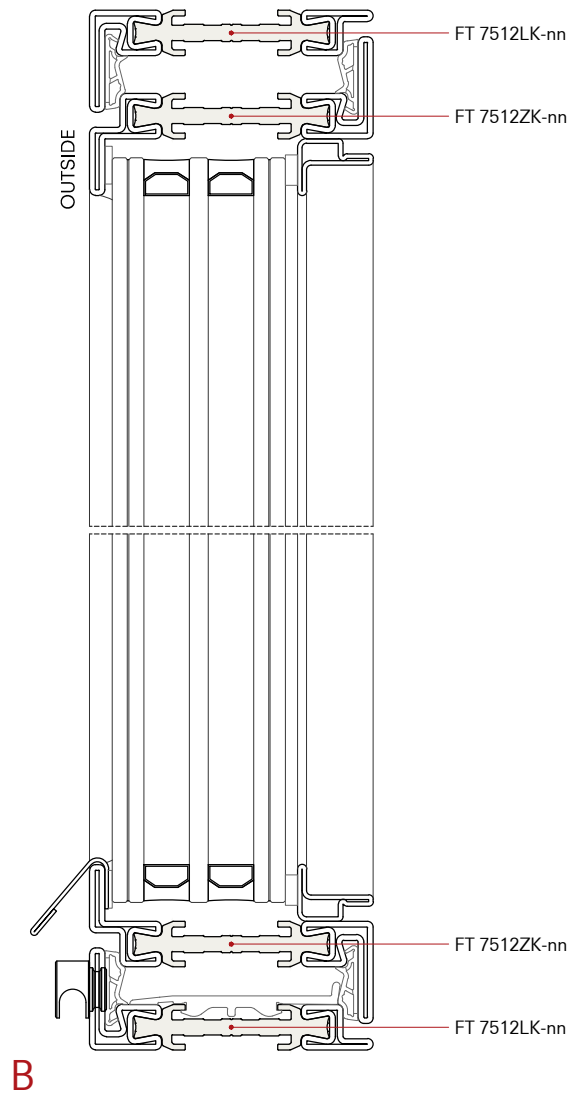
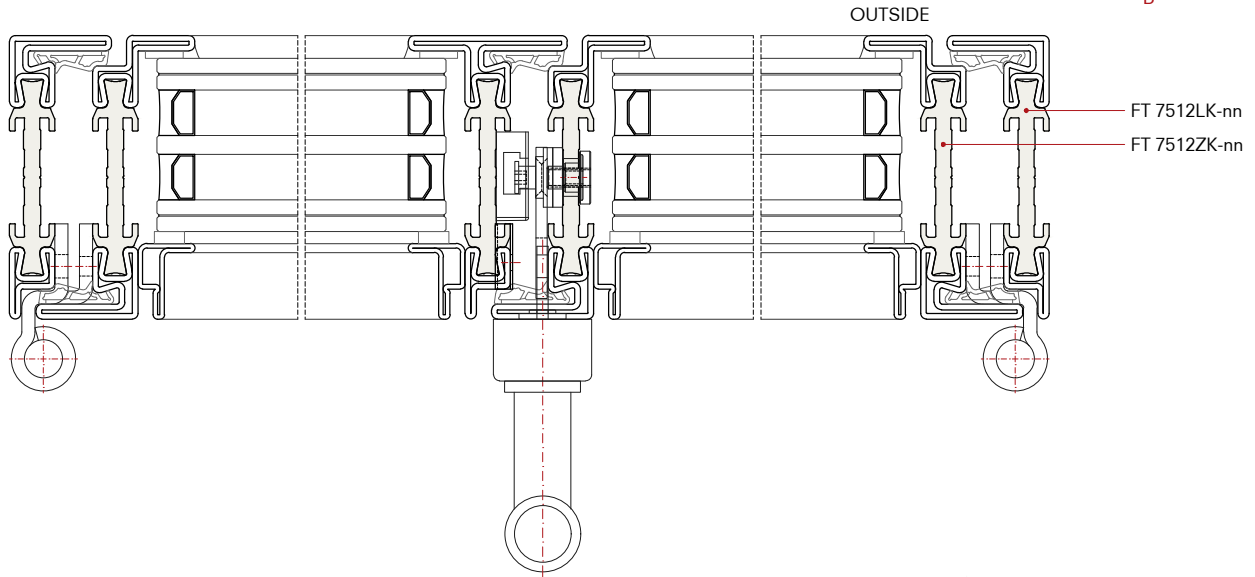

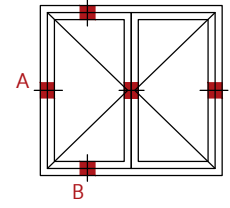

A

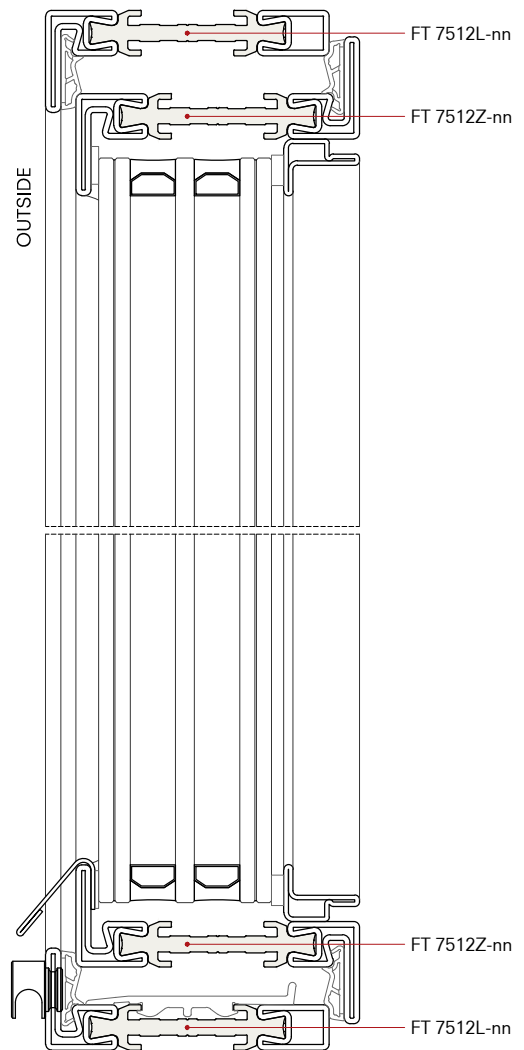
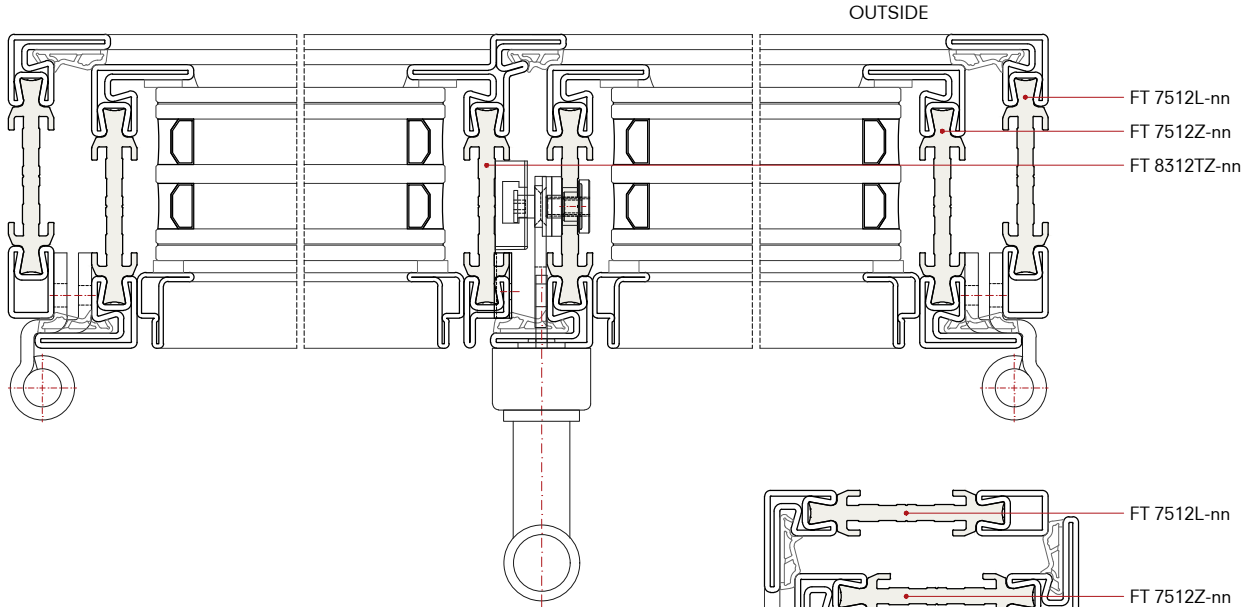

B

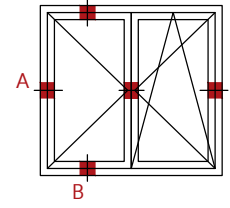

A

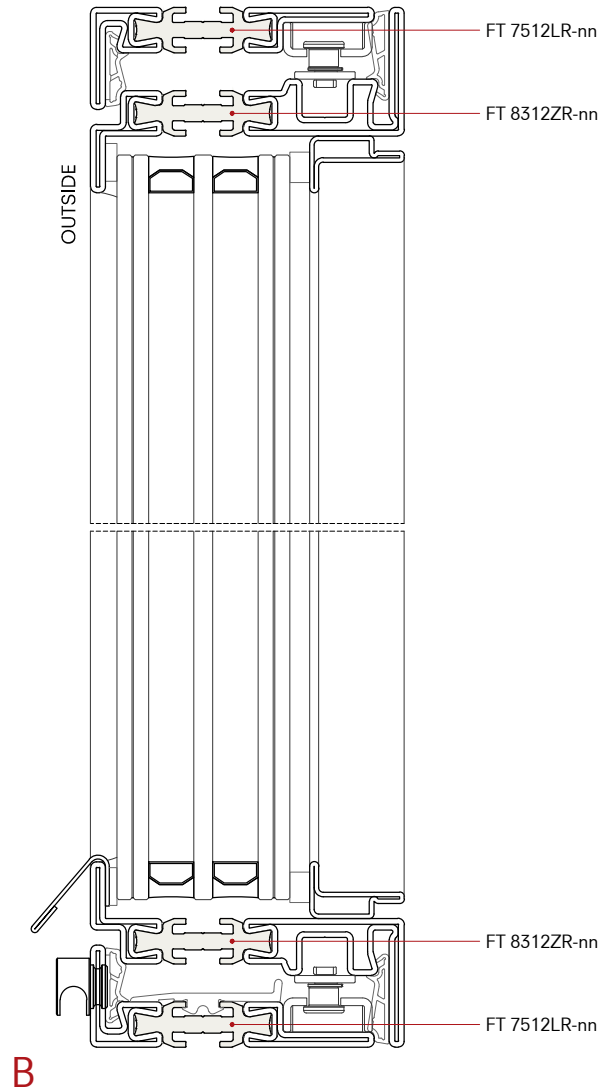
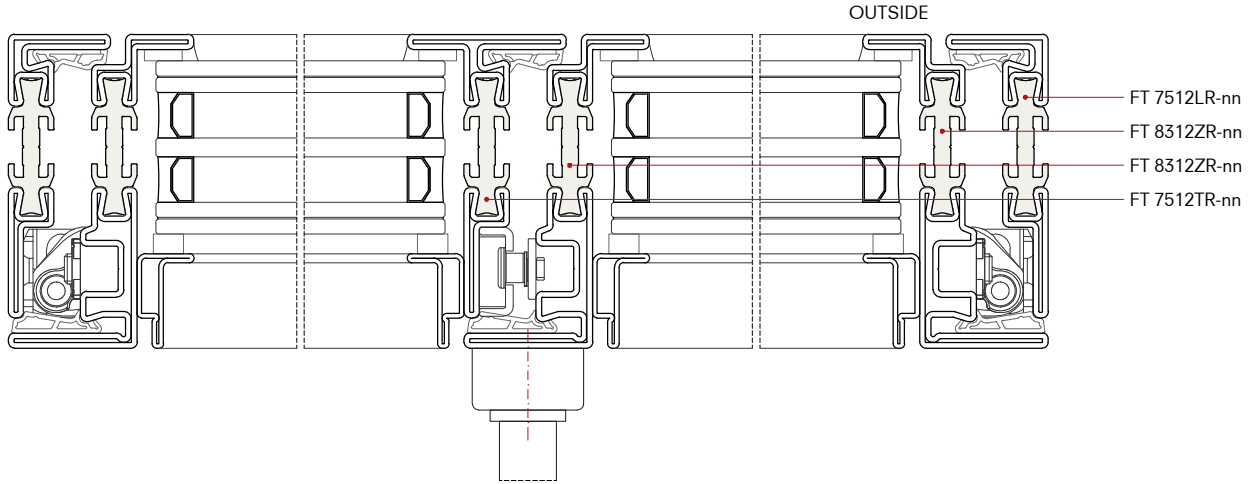

B

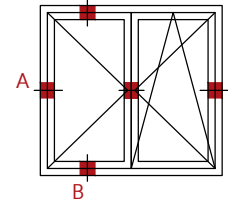

A

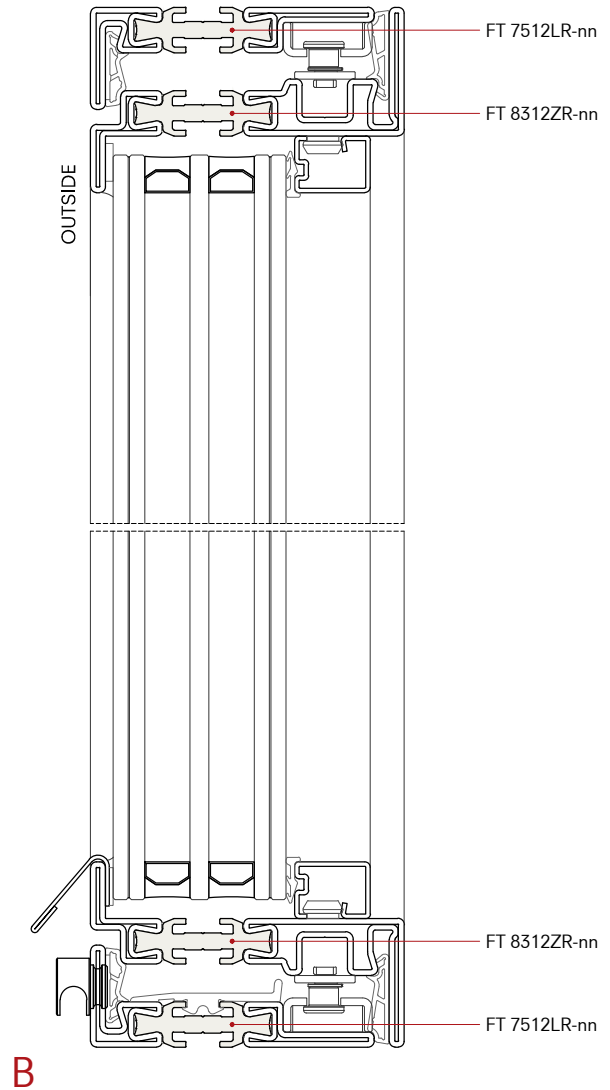
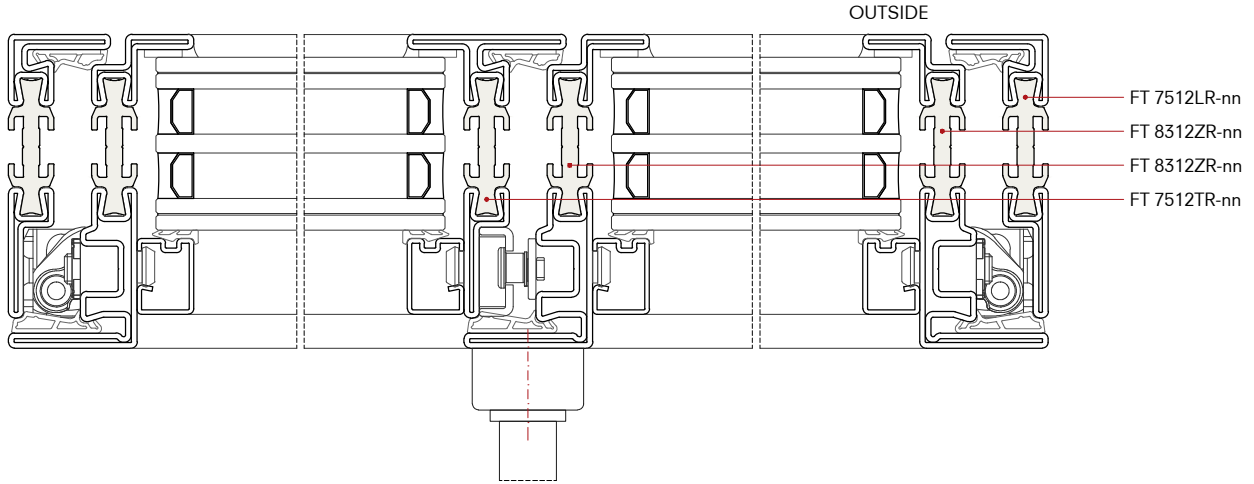

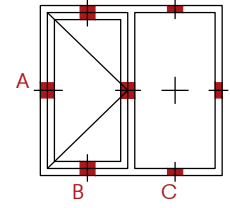

A

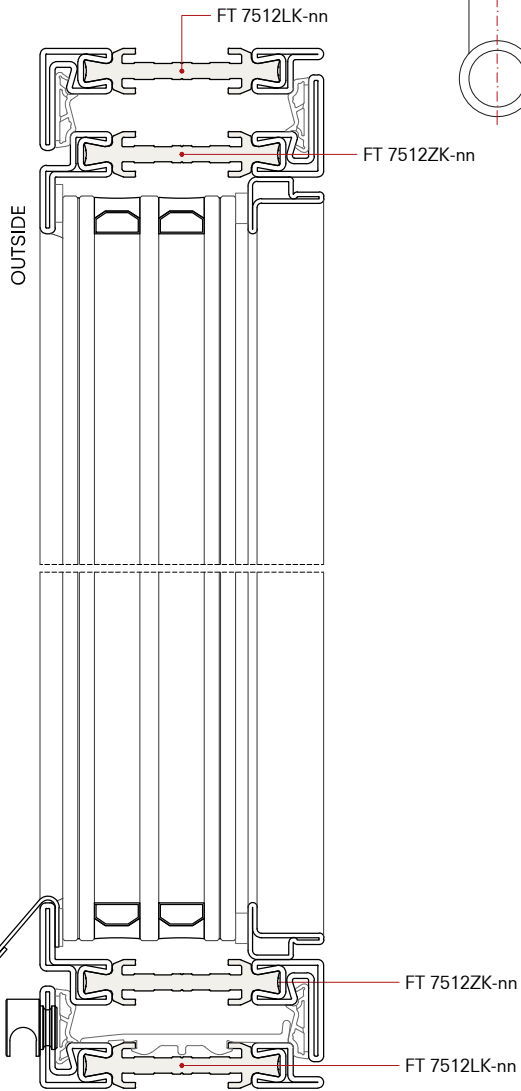
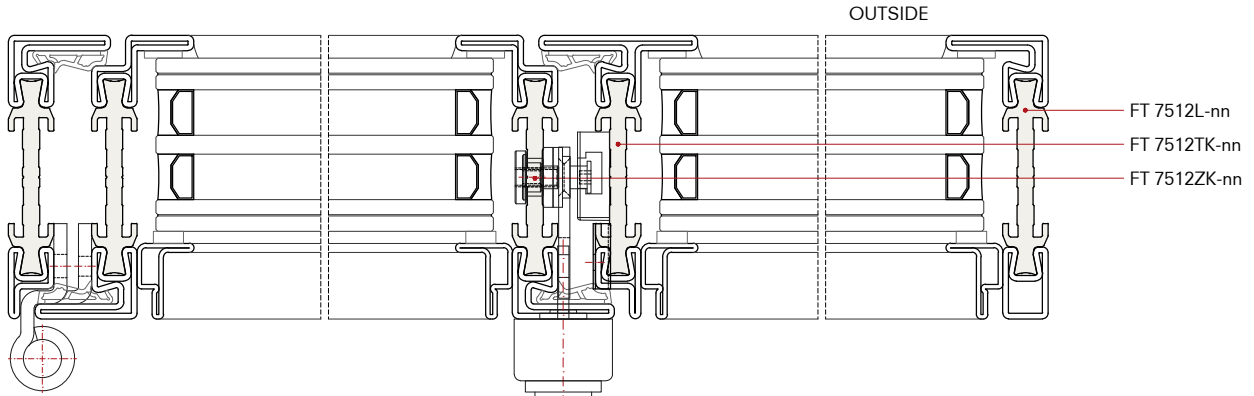

B

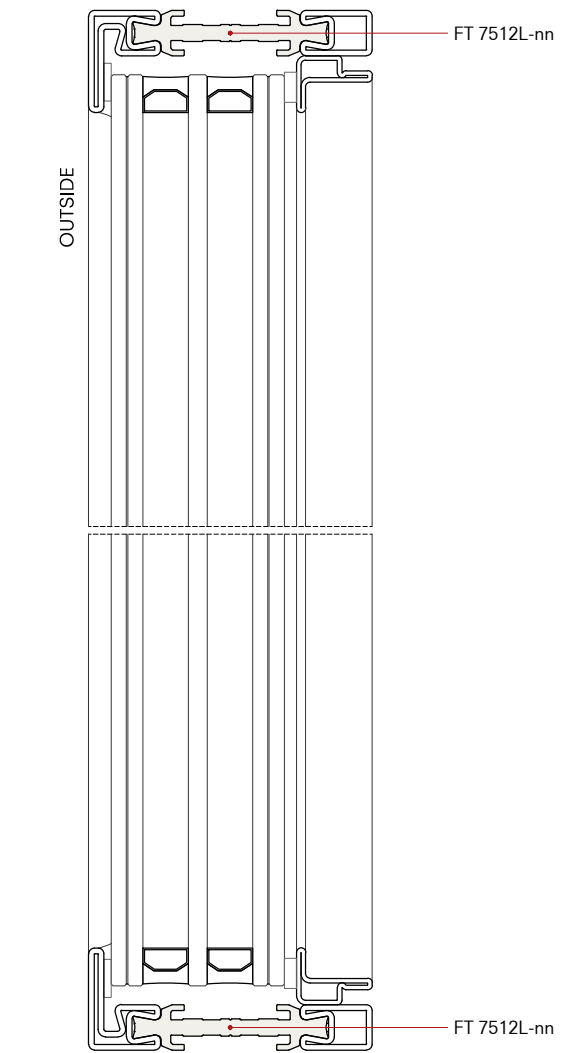

C

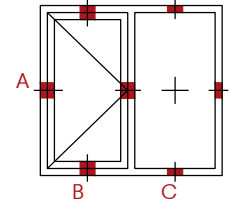

A

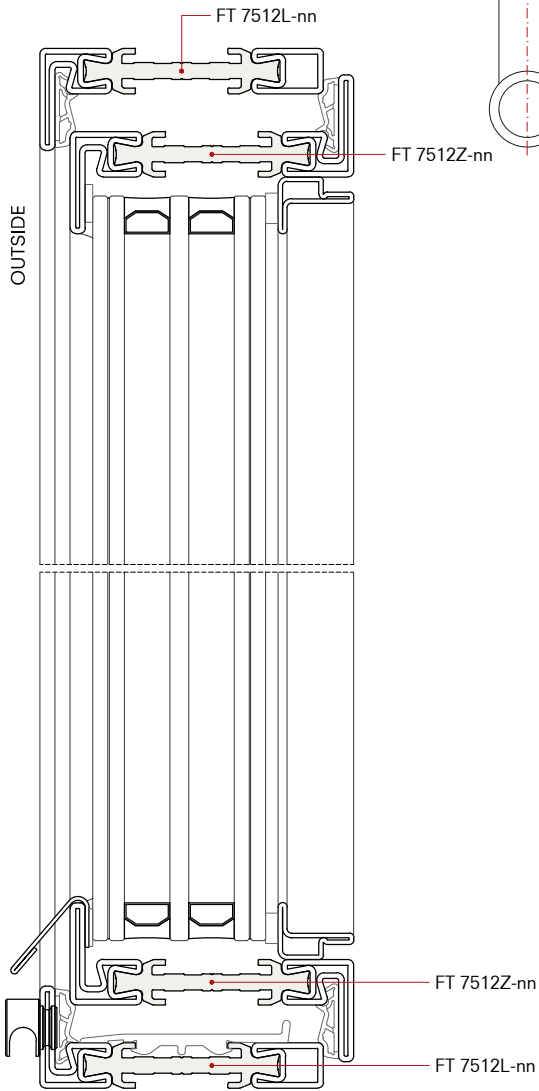
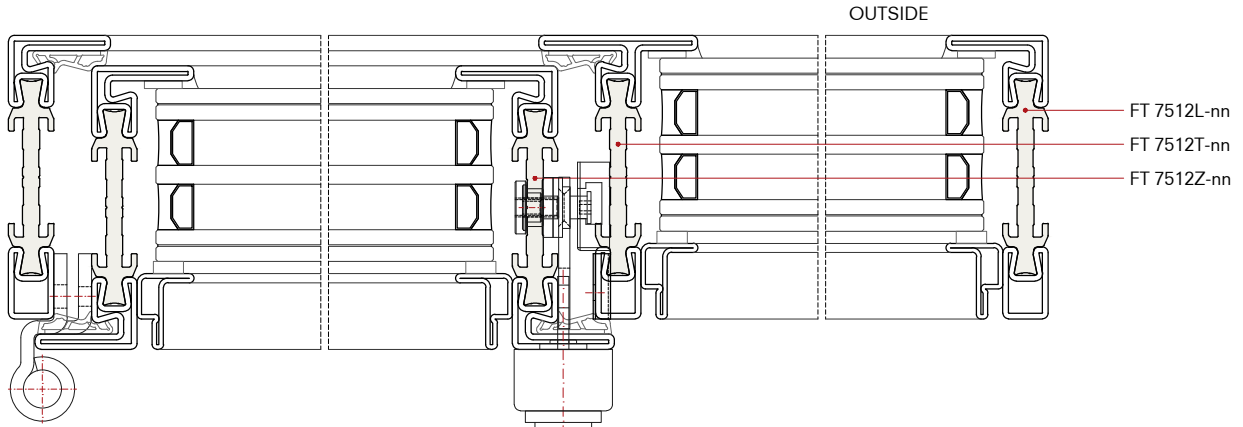

B

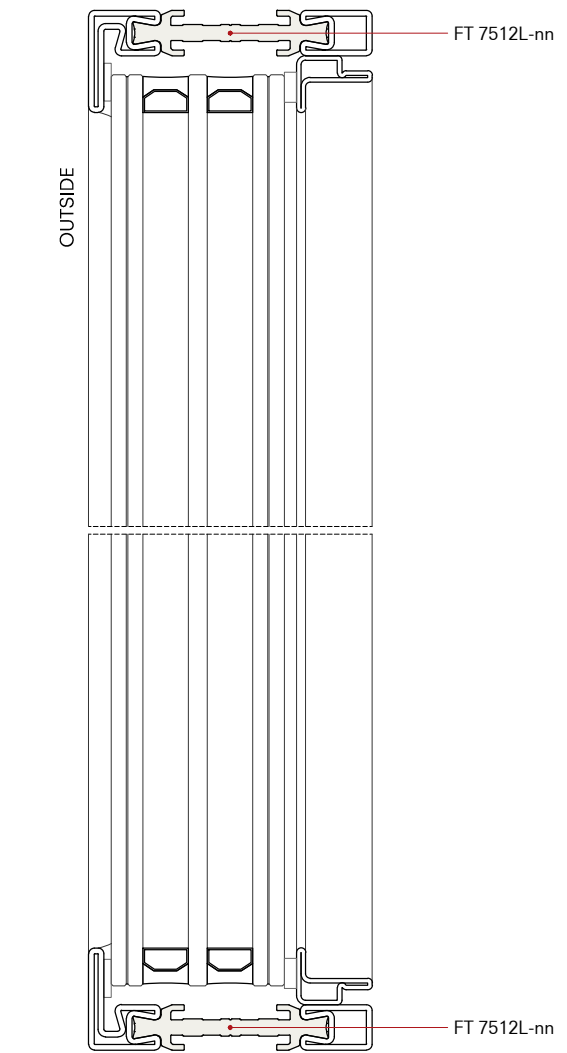

C

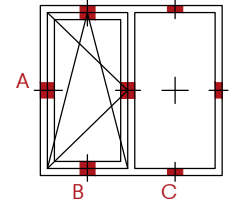

A

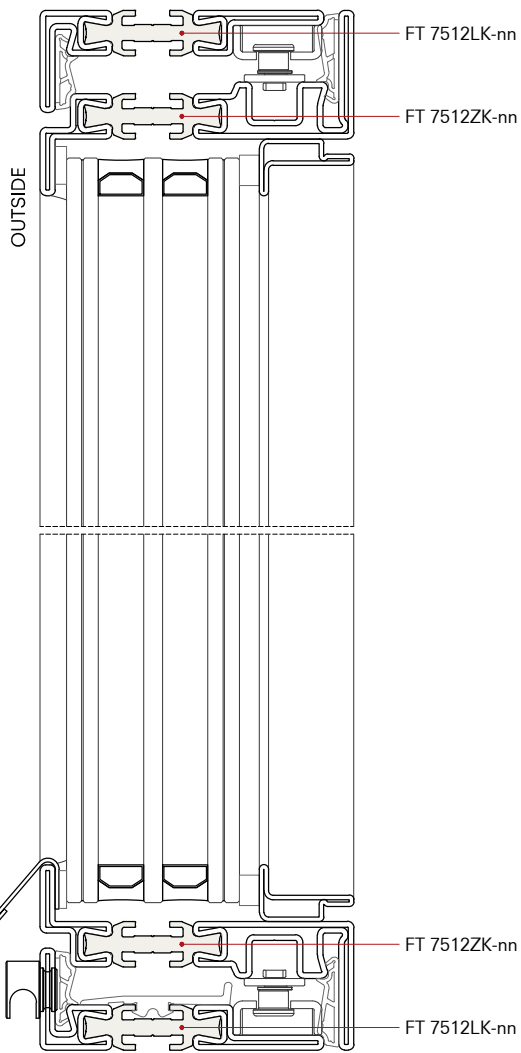
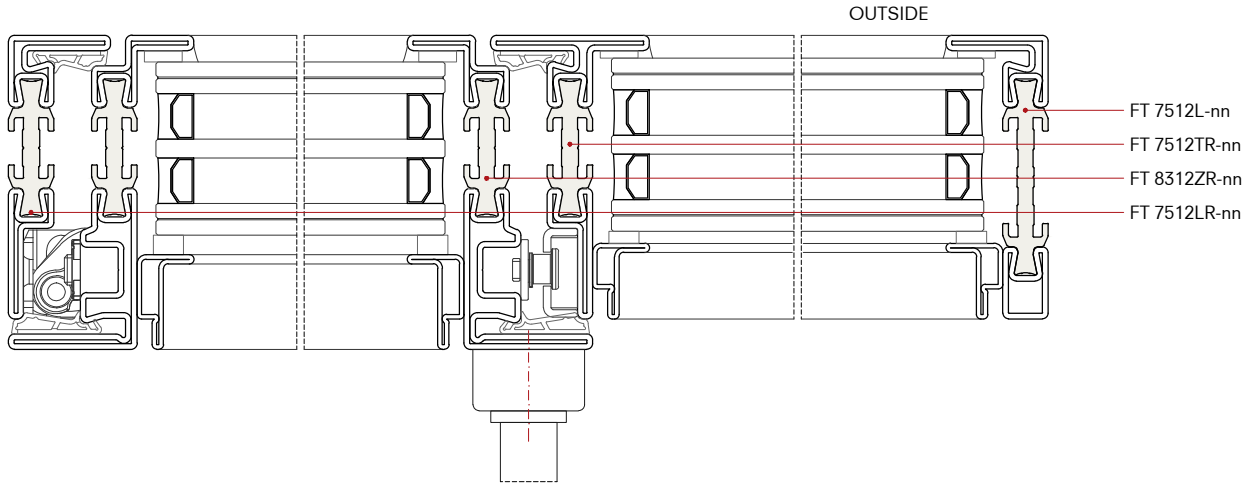

B

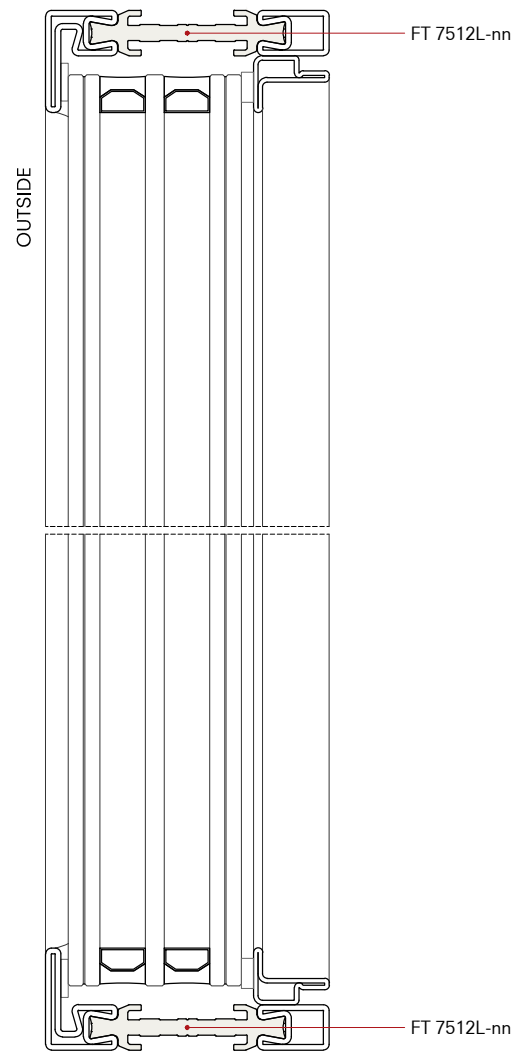

C

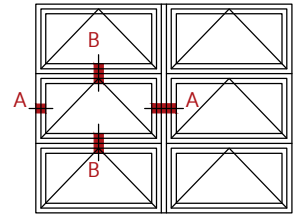

A

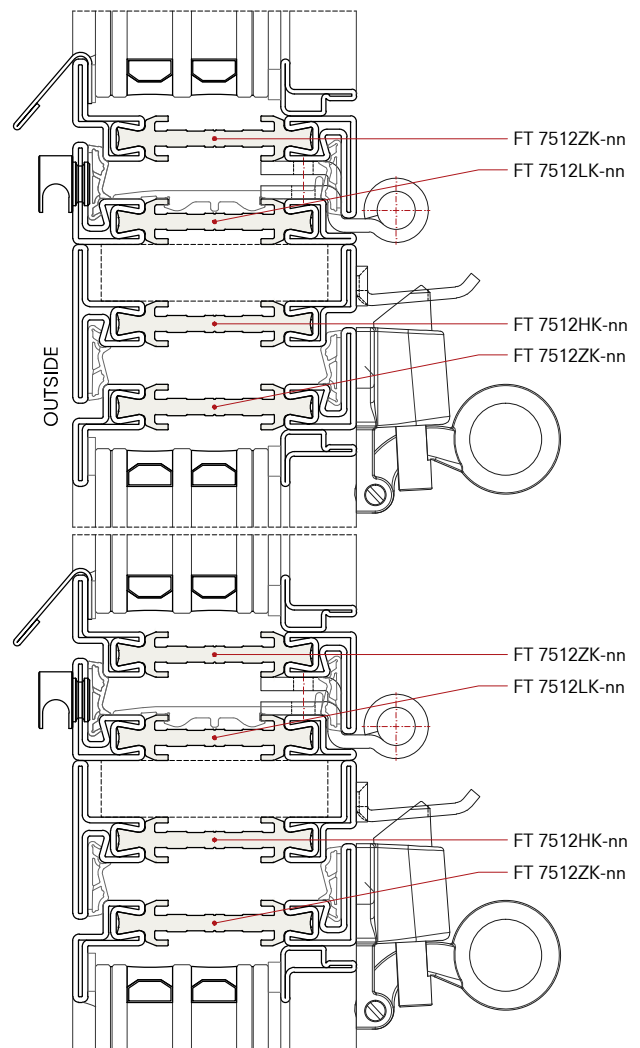
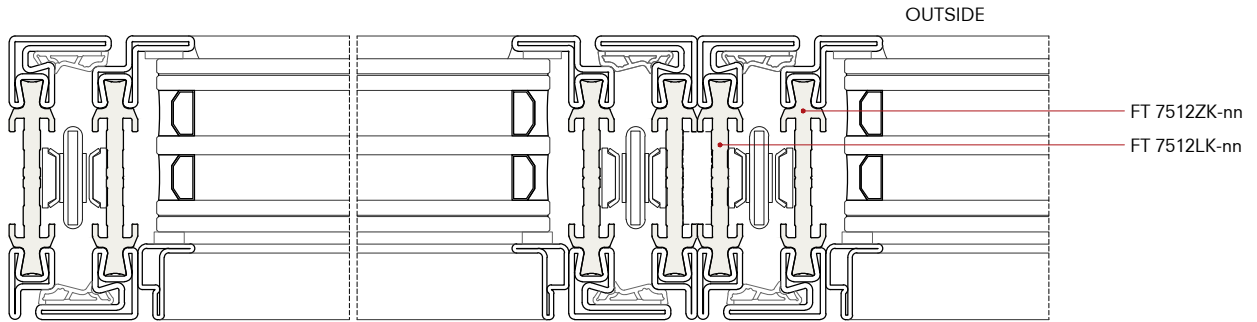

B

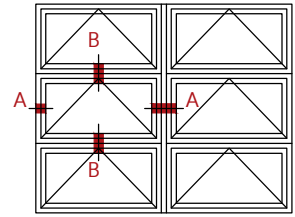

A

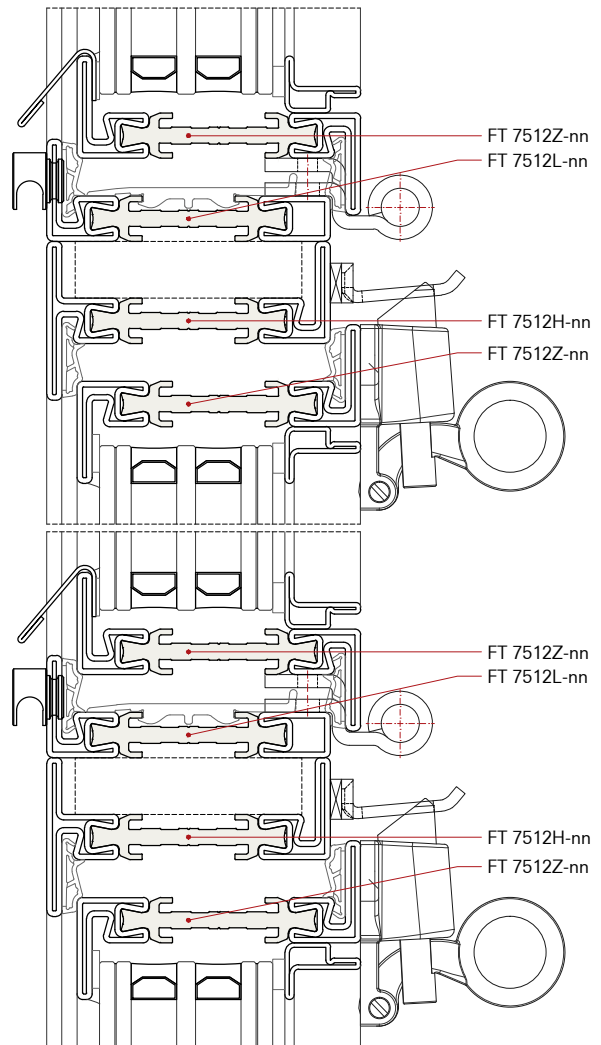
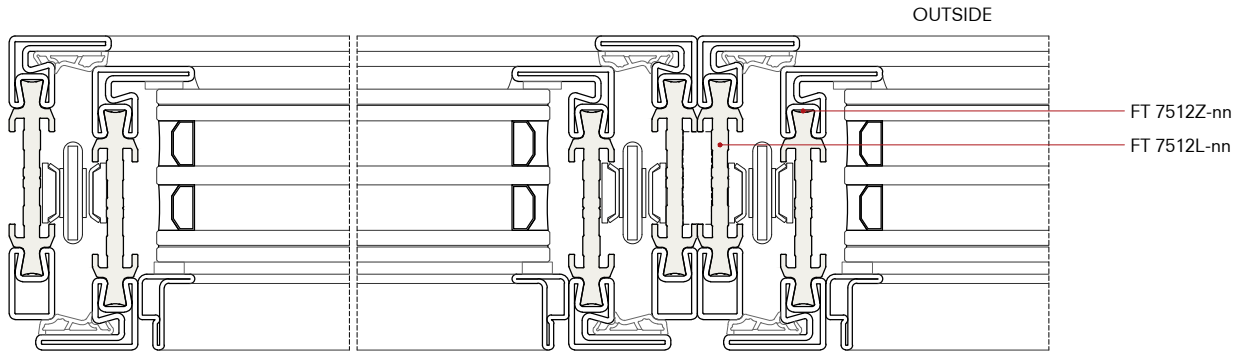

B

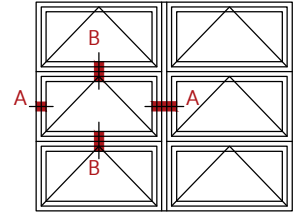

A

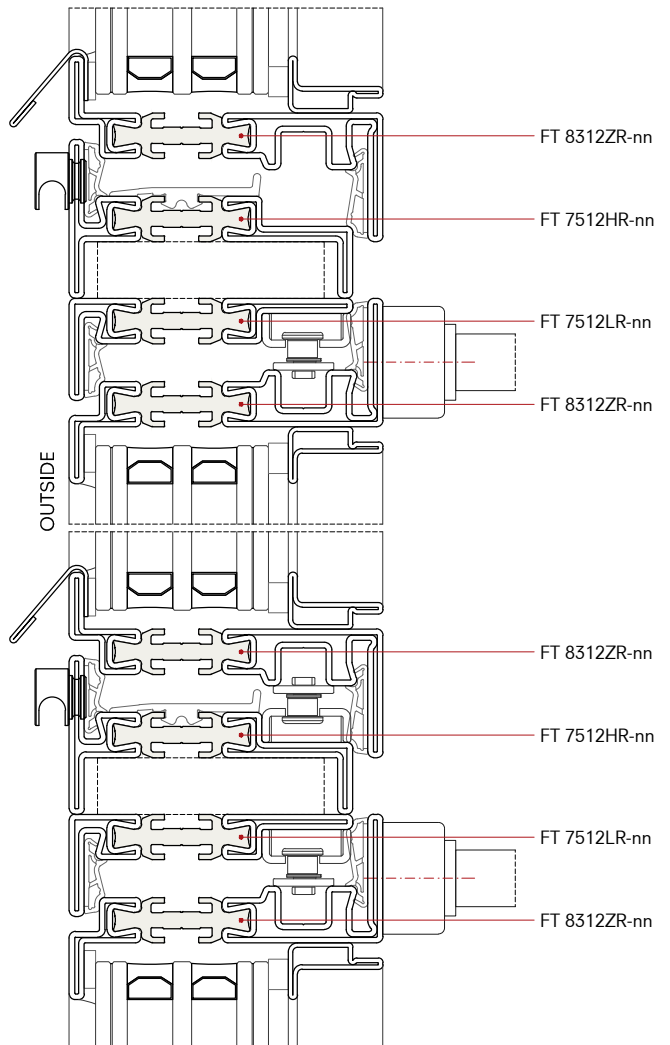
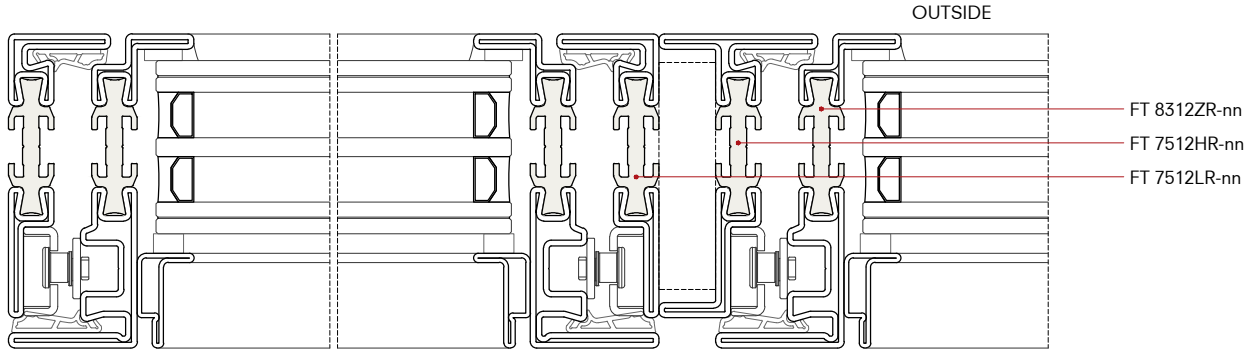

B

A

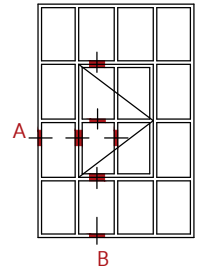
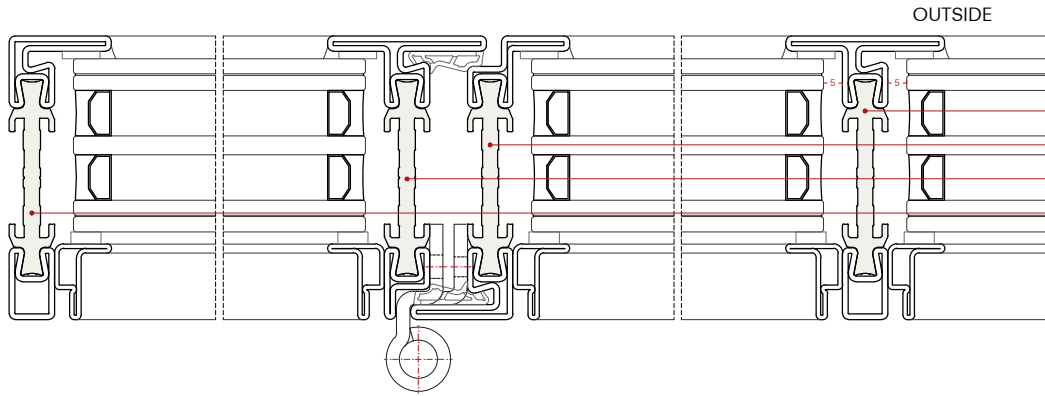

- FT 7512T-nn
- FT 7512ZK-nn
- FT 7512TK-nn
- FT 7512L-nn

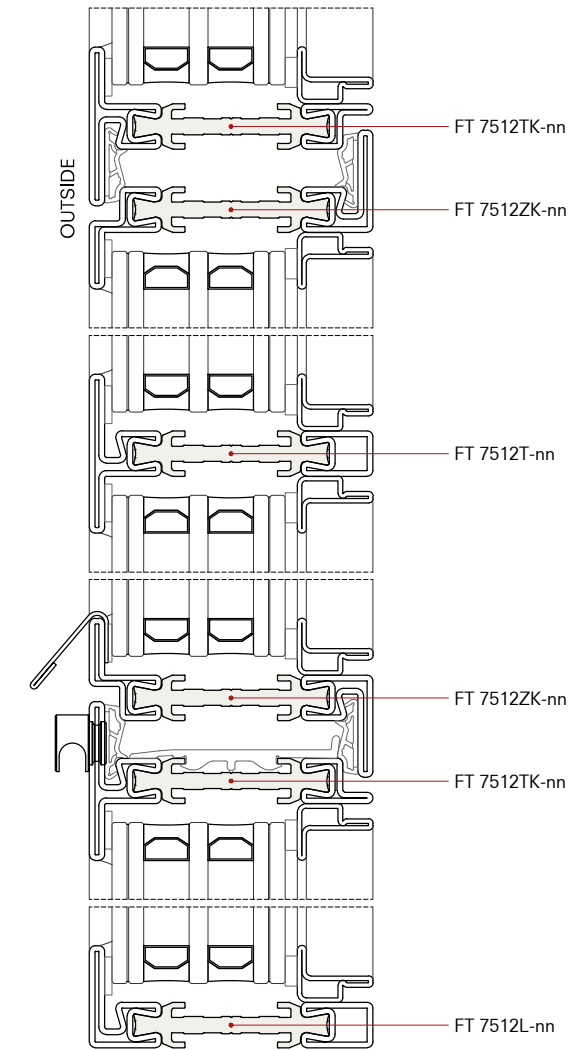

- FT 7512TK-nn
- FT 7512ZK-nn
- FT 7512T-nn
- FT 7512ZK-nn
- FT 7512TK-nn
- FT 7512L-nn

B

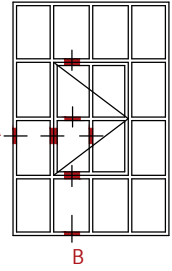

A

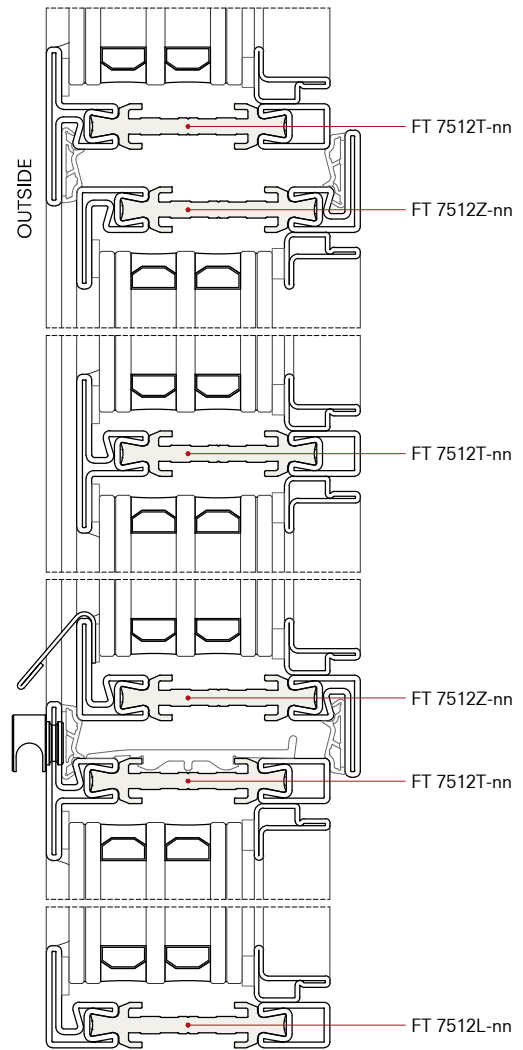
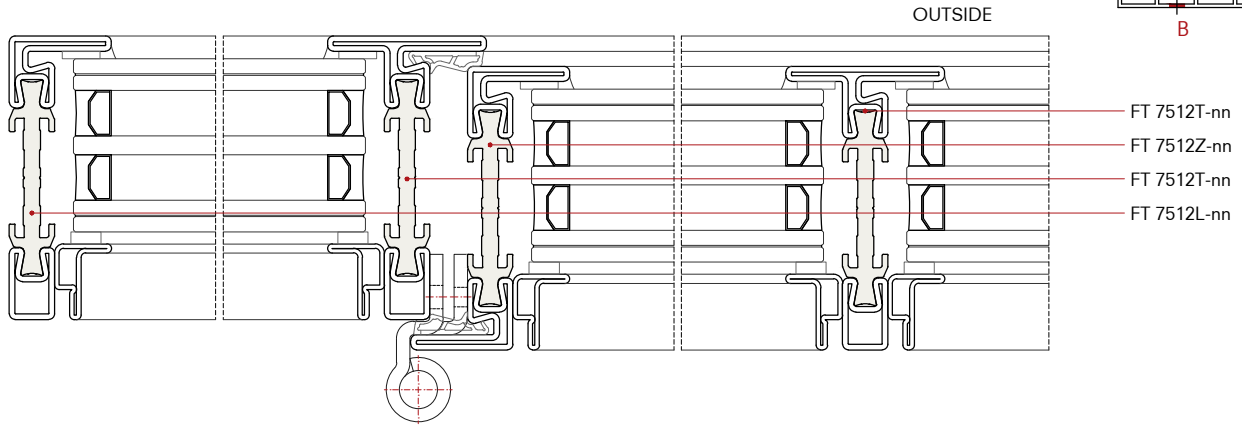

B

A

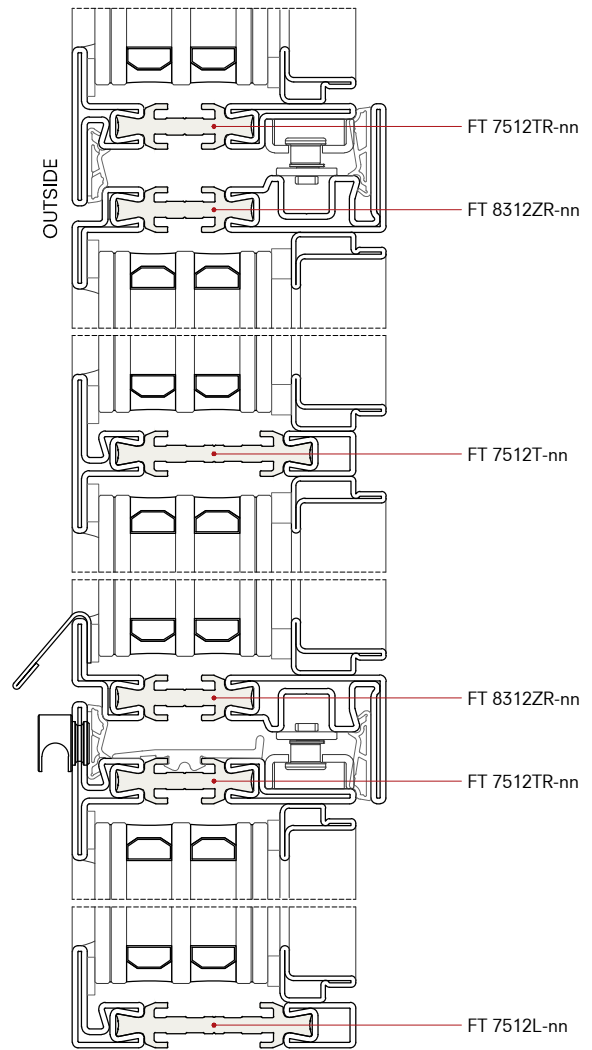
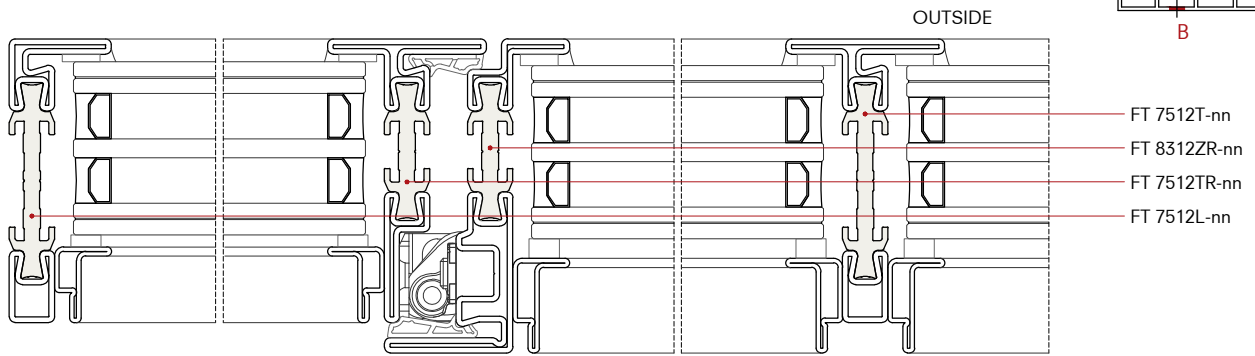

B

A

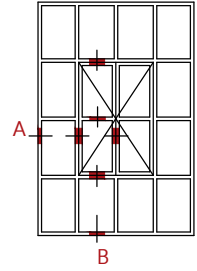
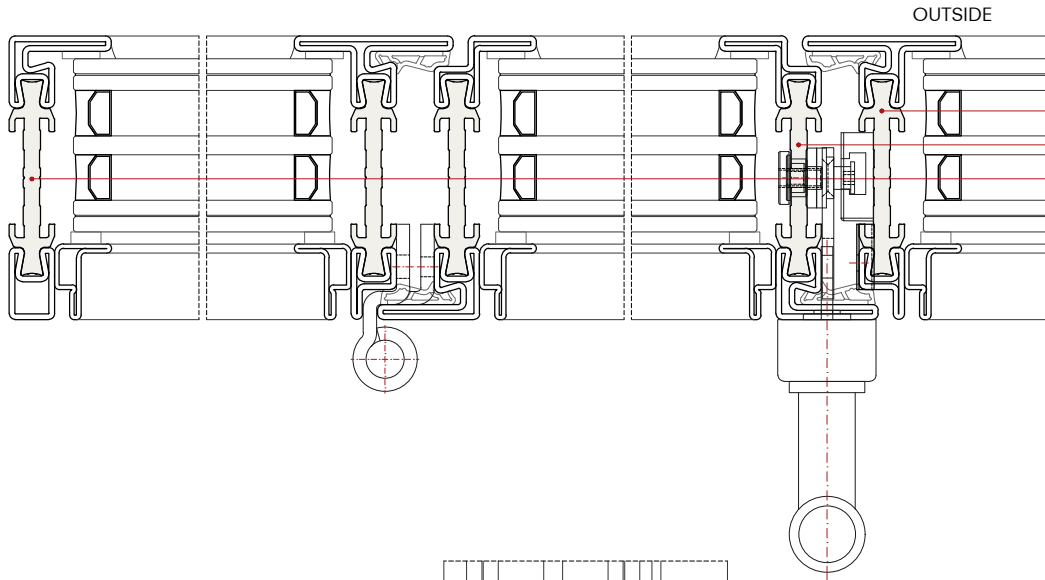

- FT 7512TK-nn
- FT 8312ZK-nn
- FT 7512L-nn

B

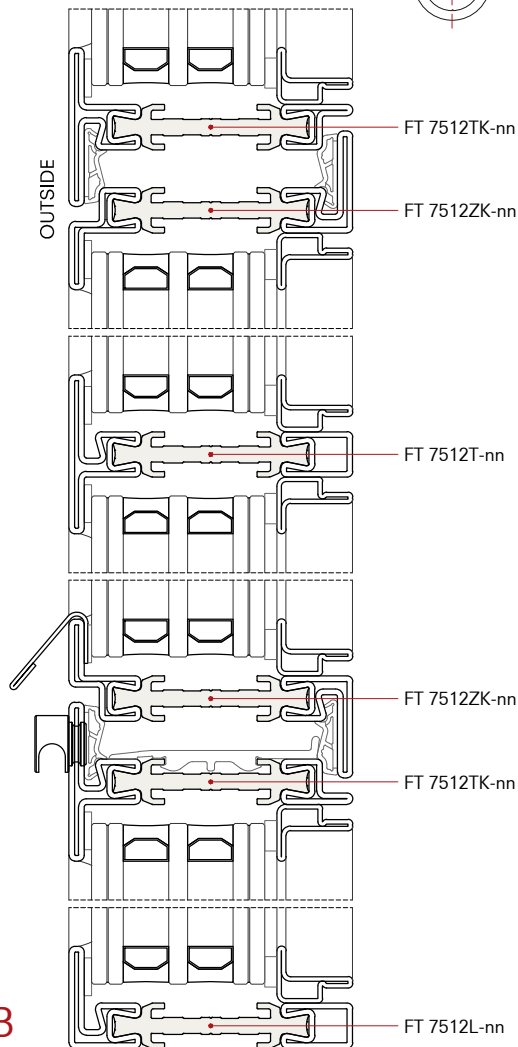

- FT 7512TK-nn
- FT 7512ZK-nn
- FT 7512T-nn
- FT 7512ZK-nn
- FT 7512TK-nn
- FT 7512L-nn

A

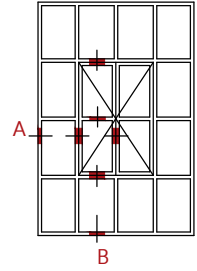
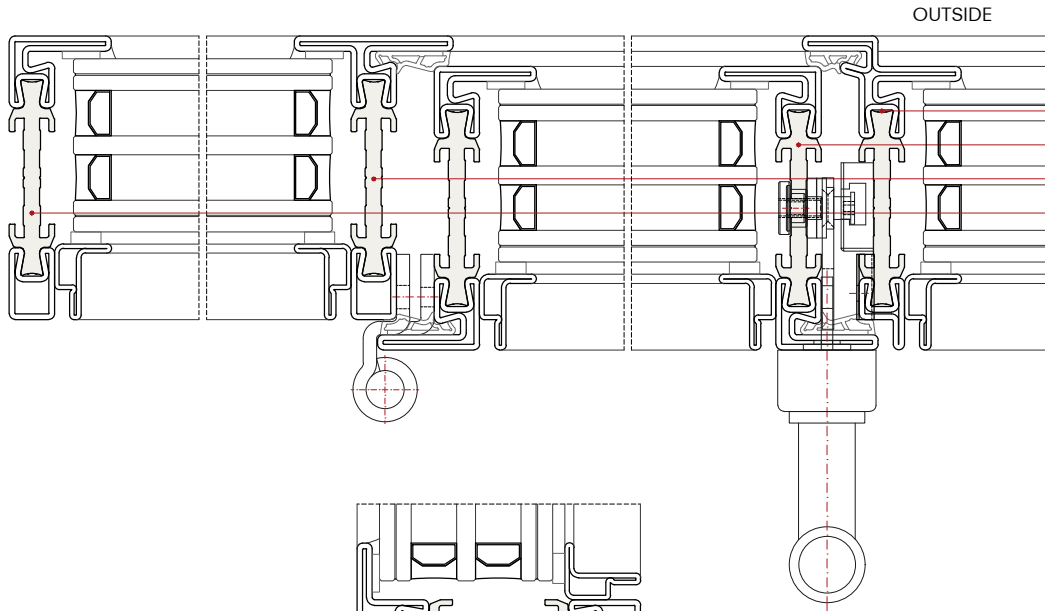

- FT 8312TZ-nn
- FT 7512Z-nn
- FT 7512T-nn
- FT 7512L-nn

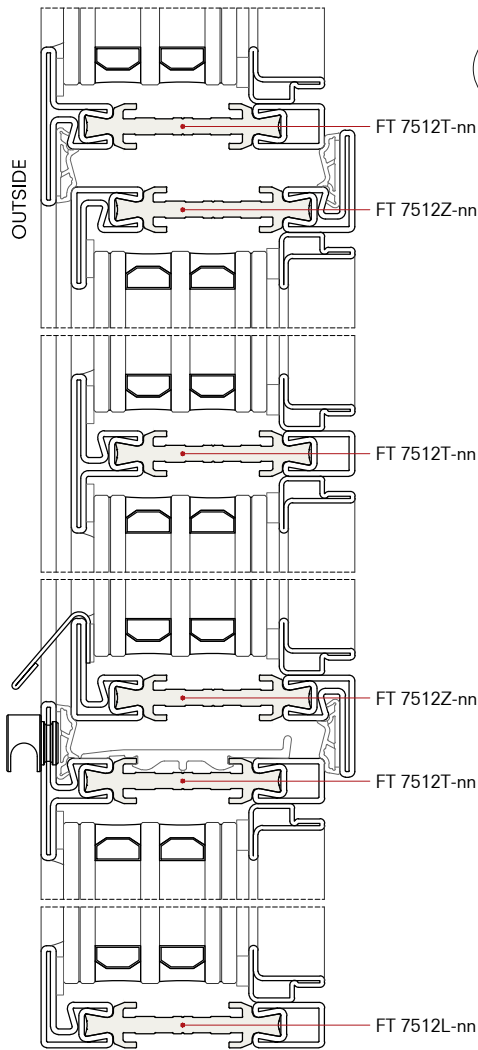

B

A

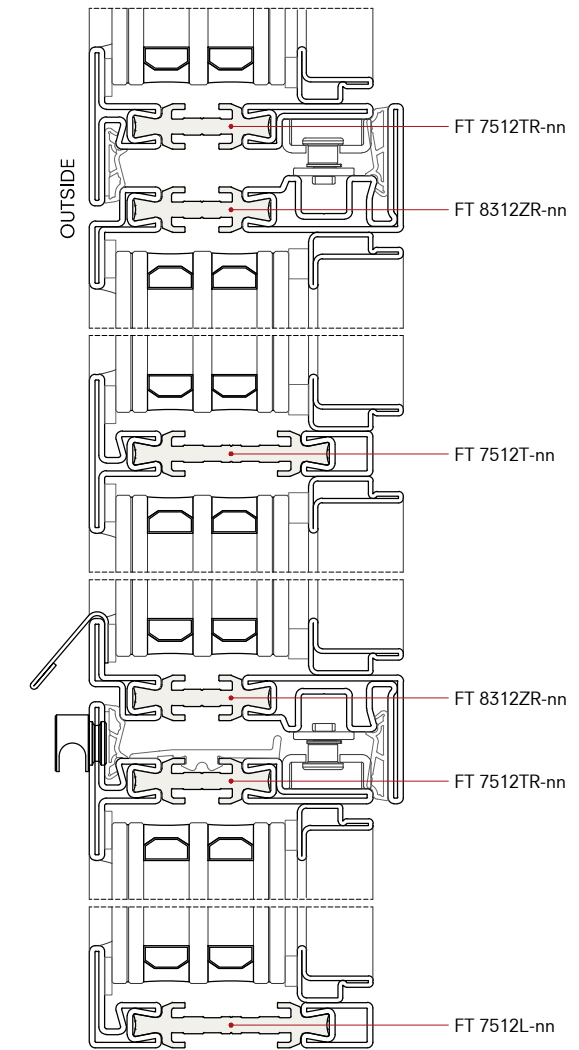
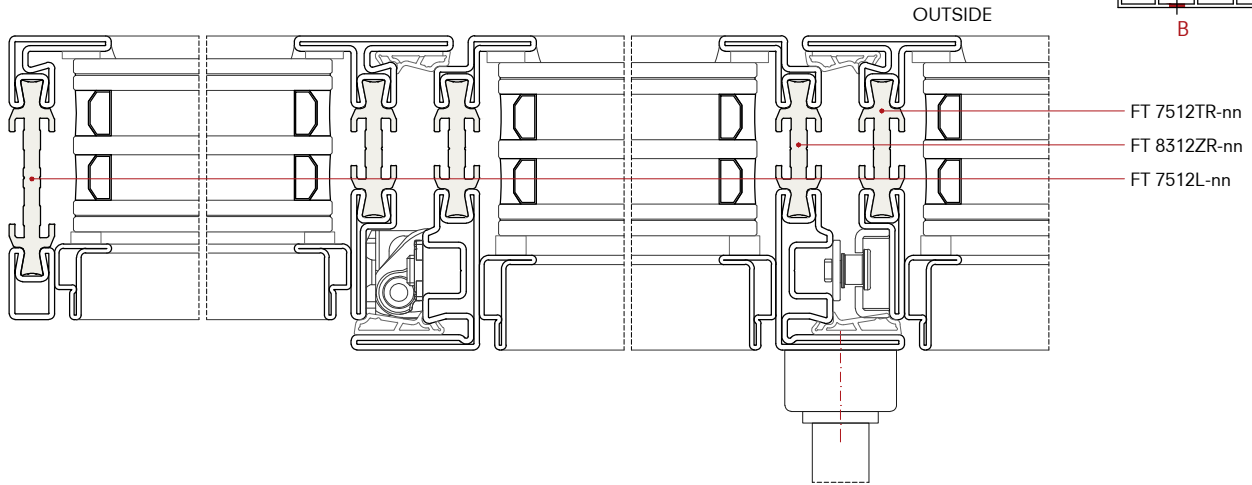

B

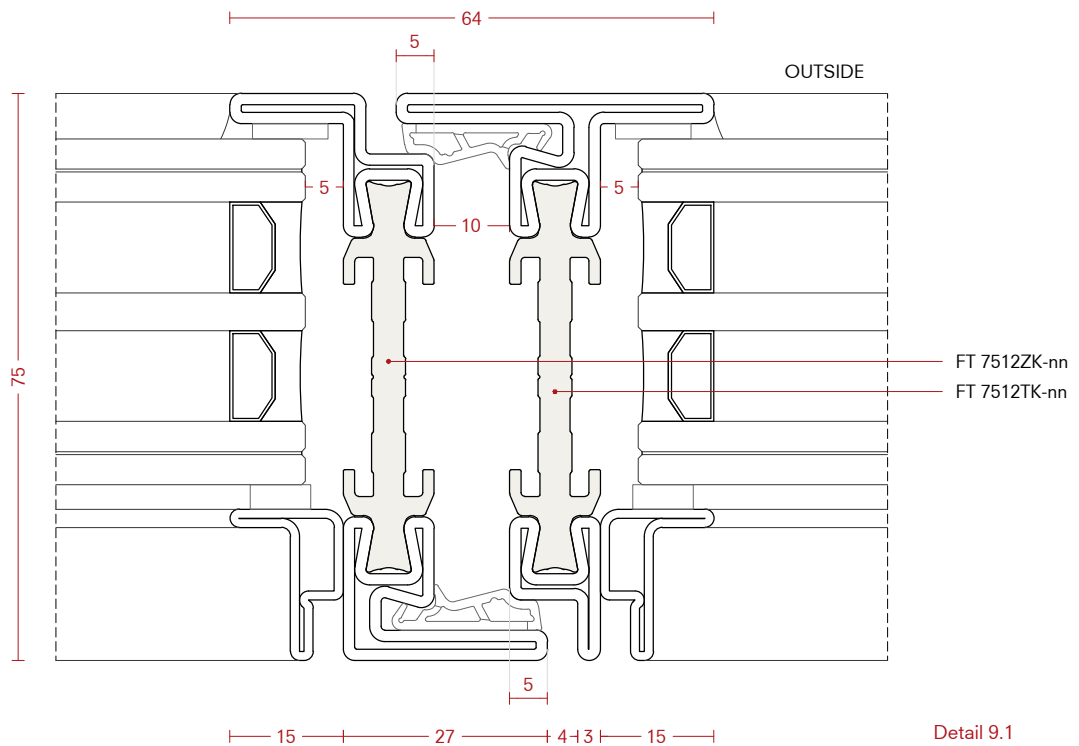
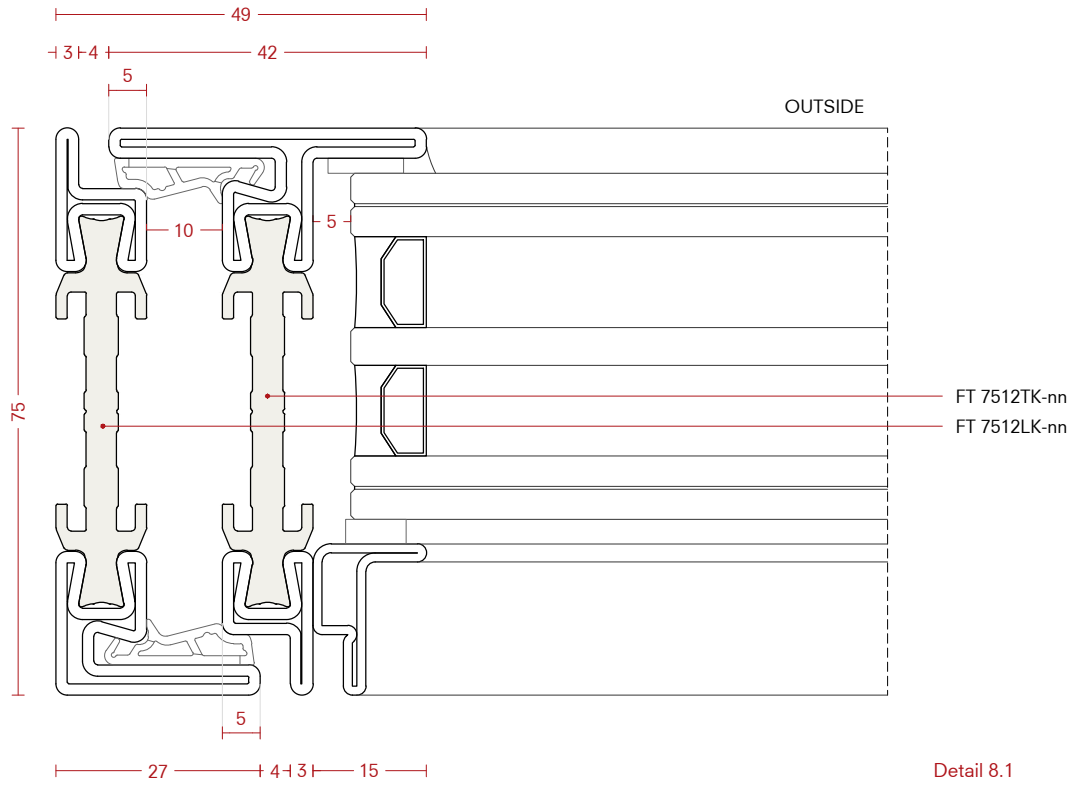
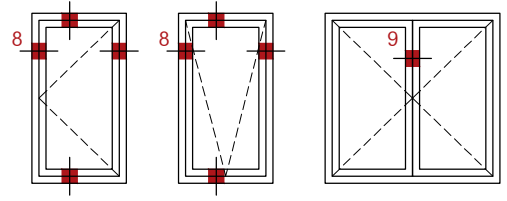

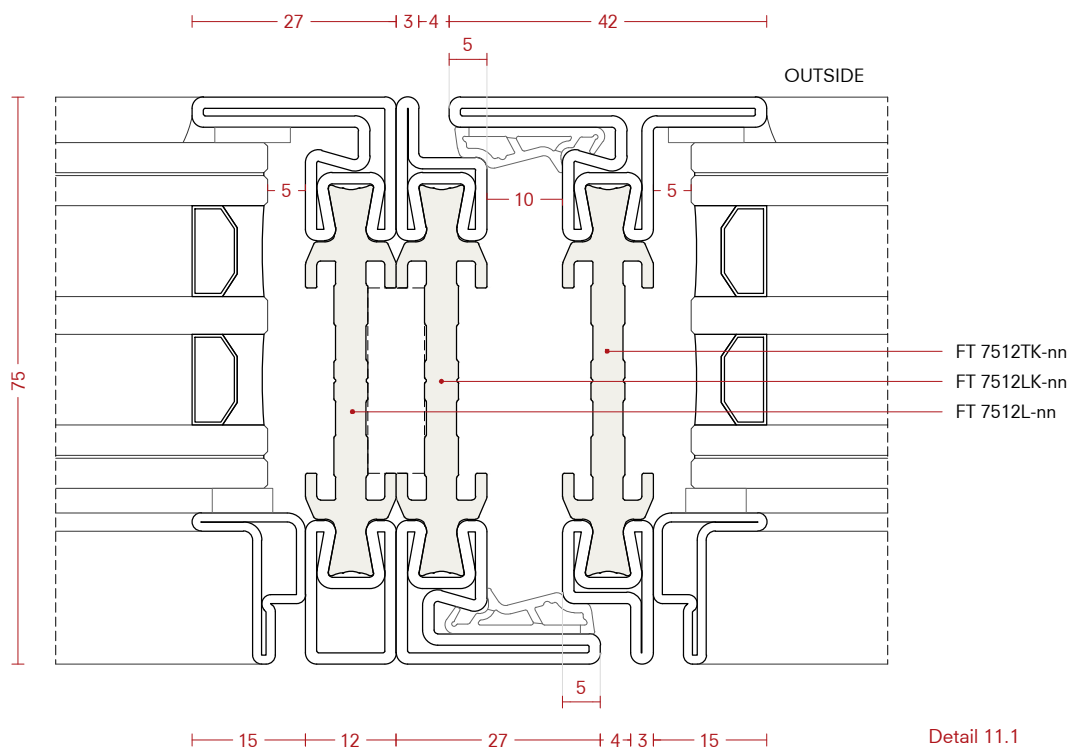
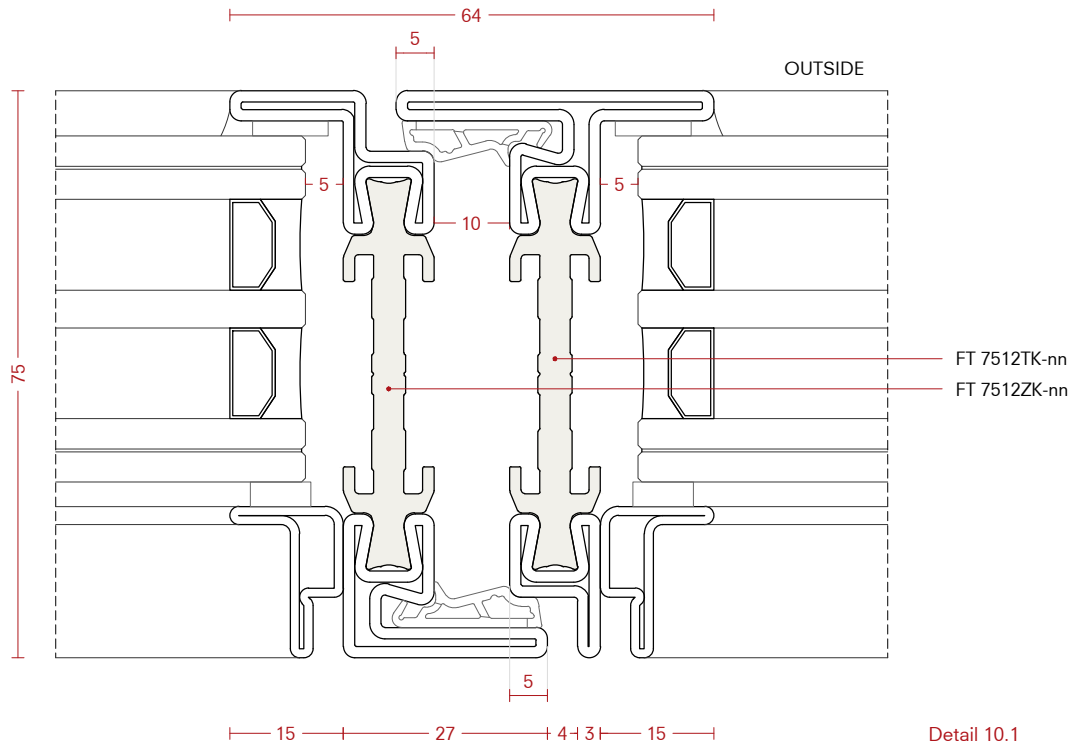
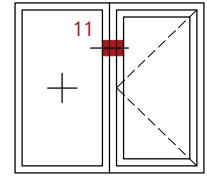
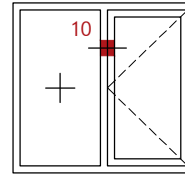

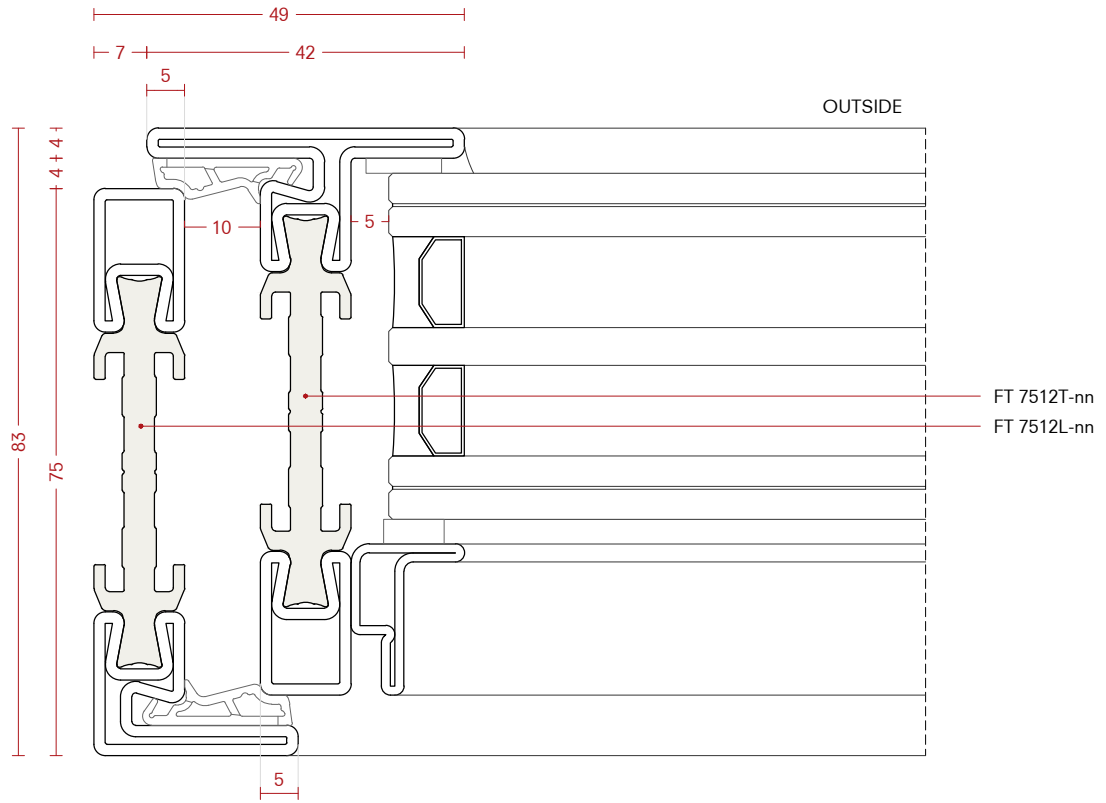
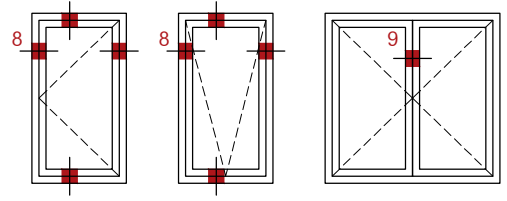

Detail 8.2

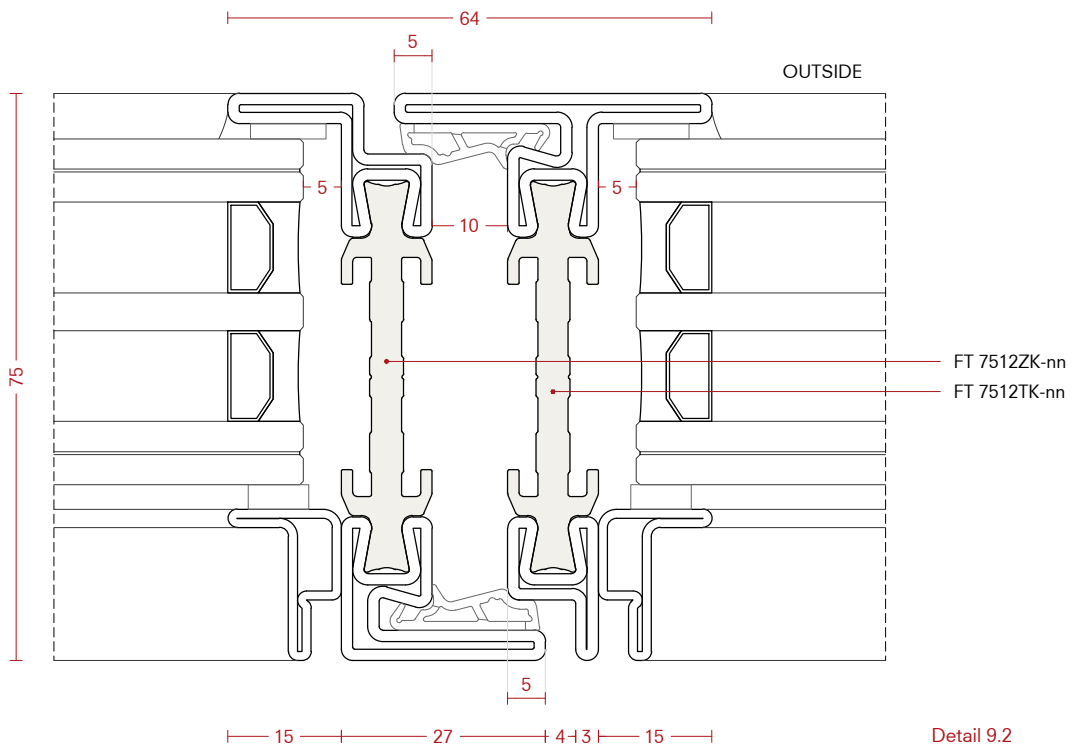

Detail 9.2

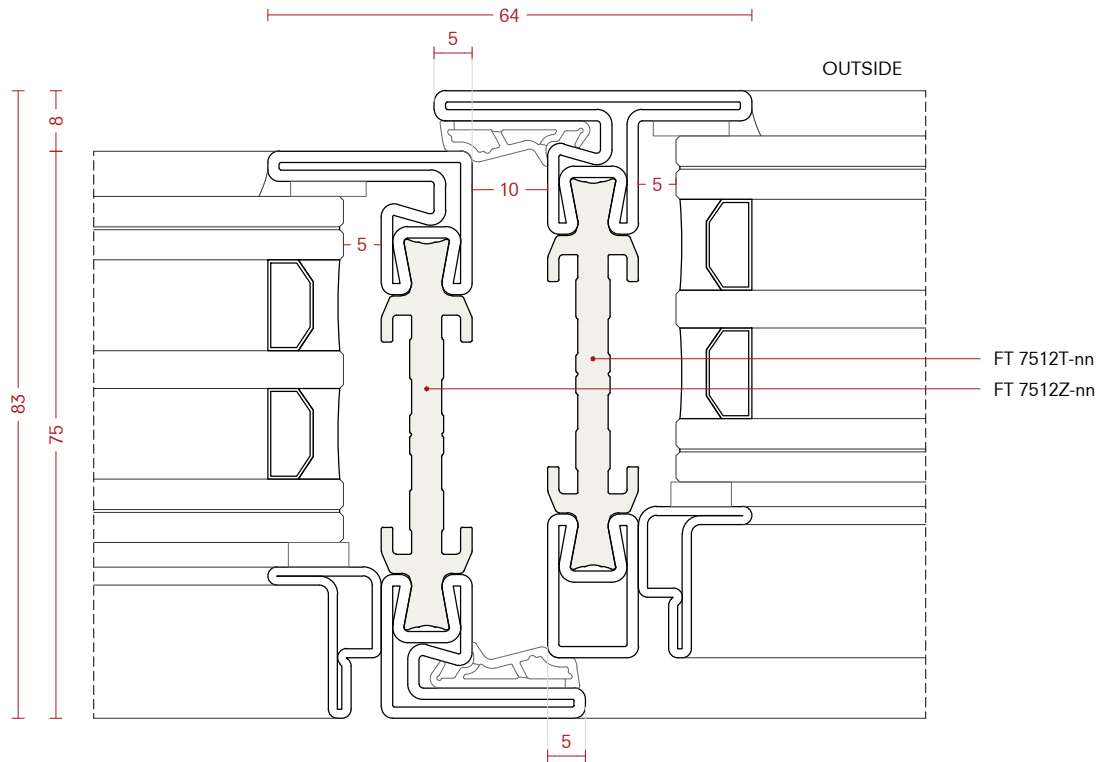
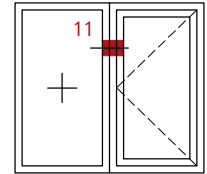
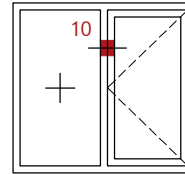

Detail 10.2

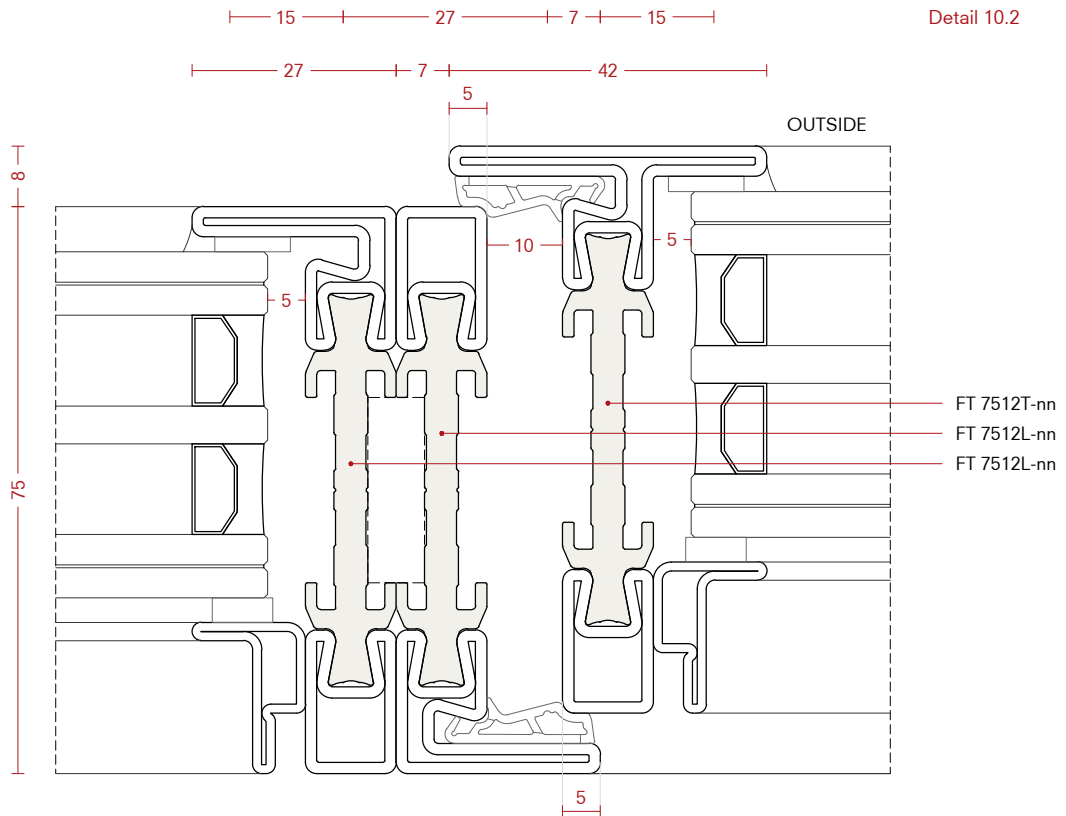

Detail 11.2

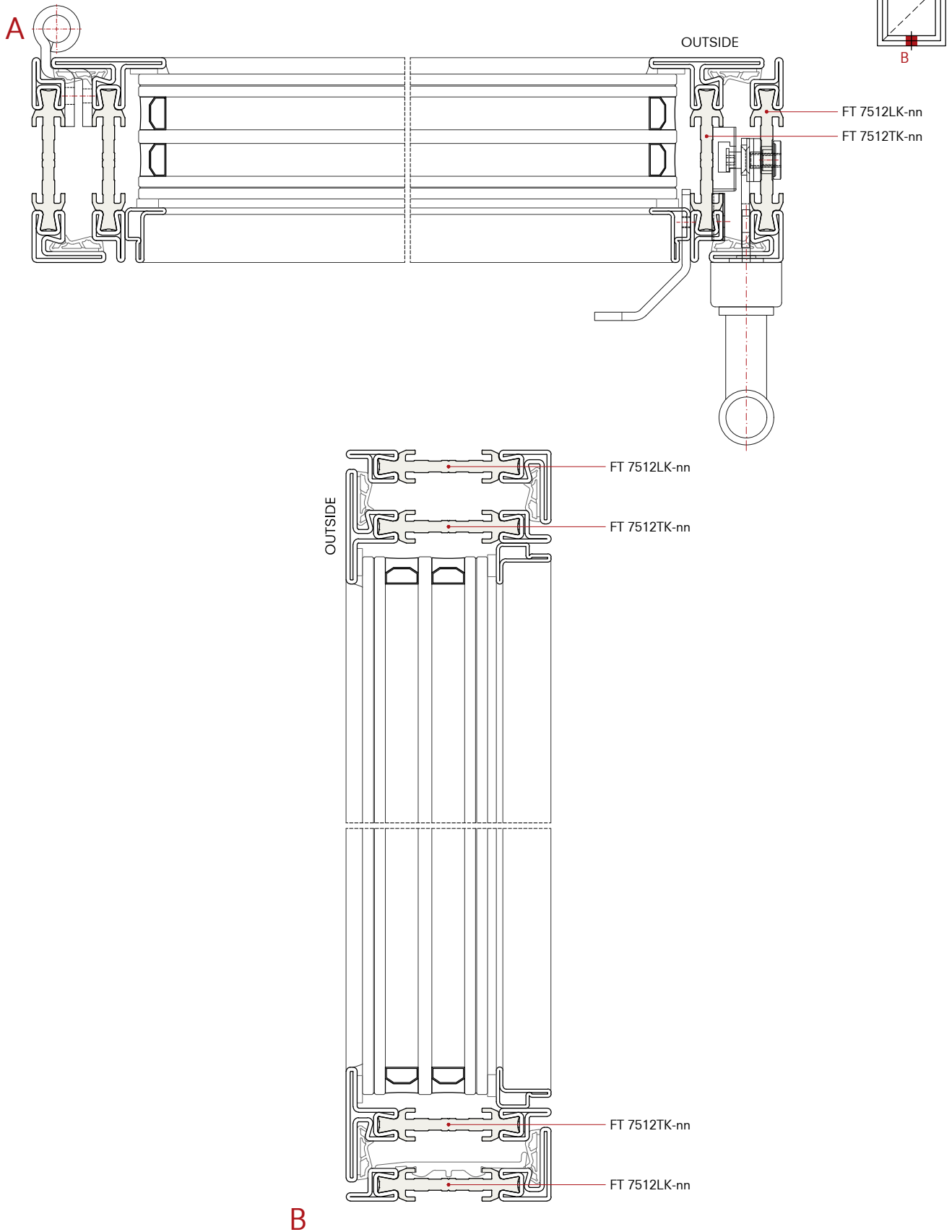

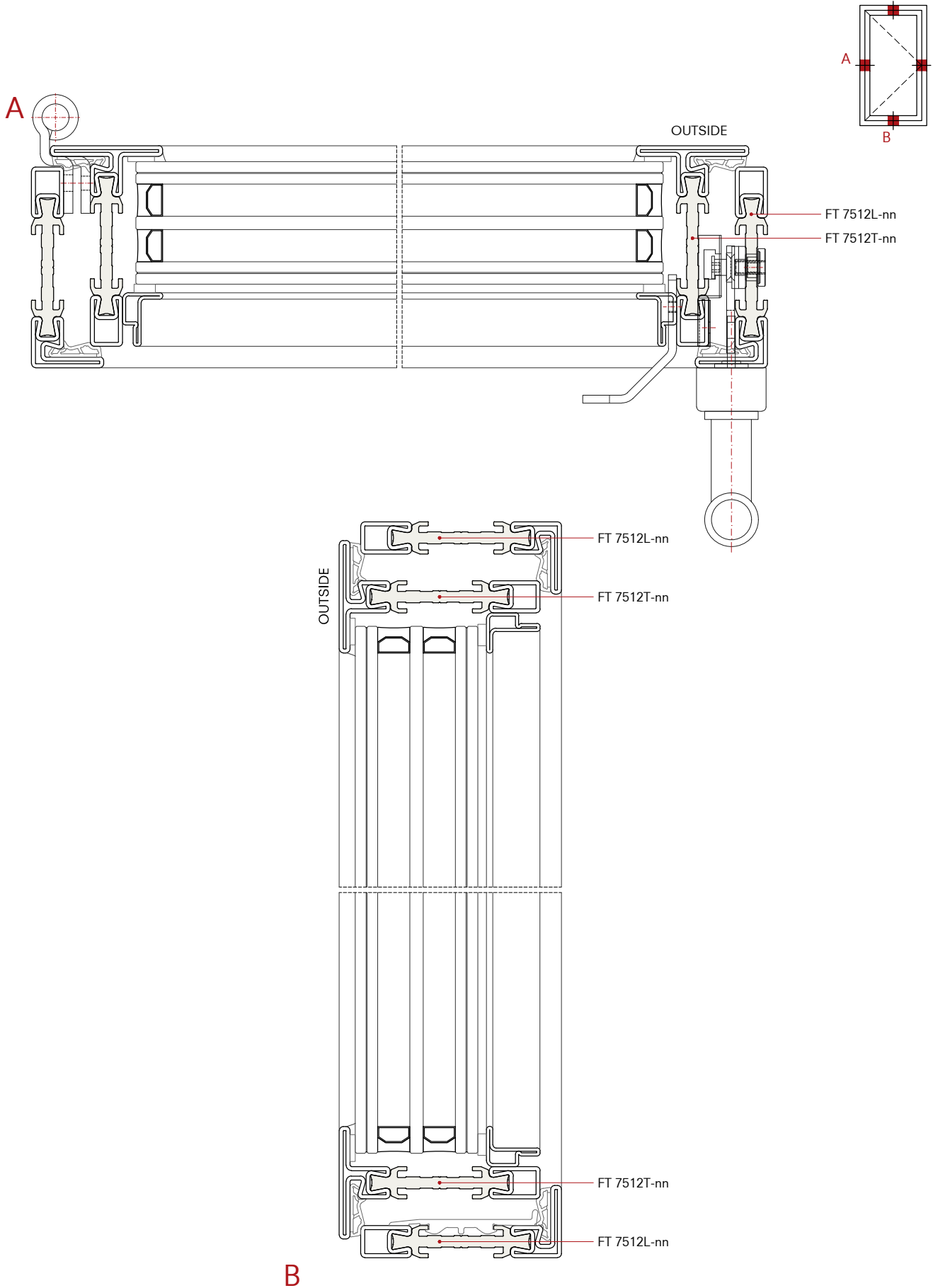

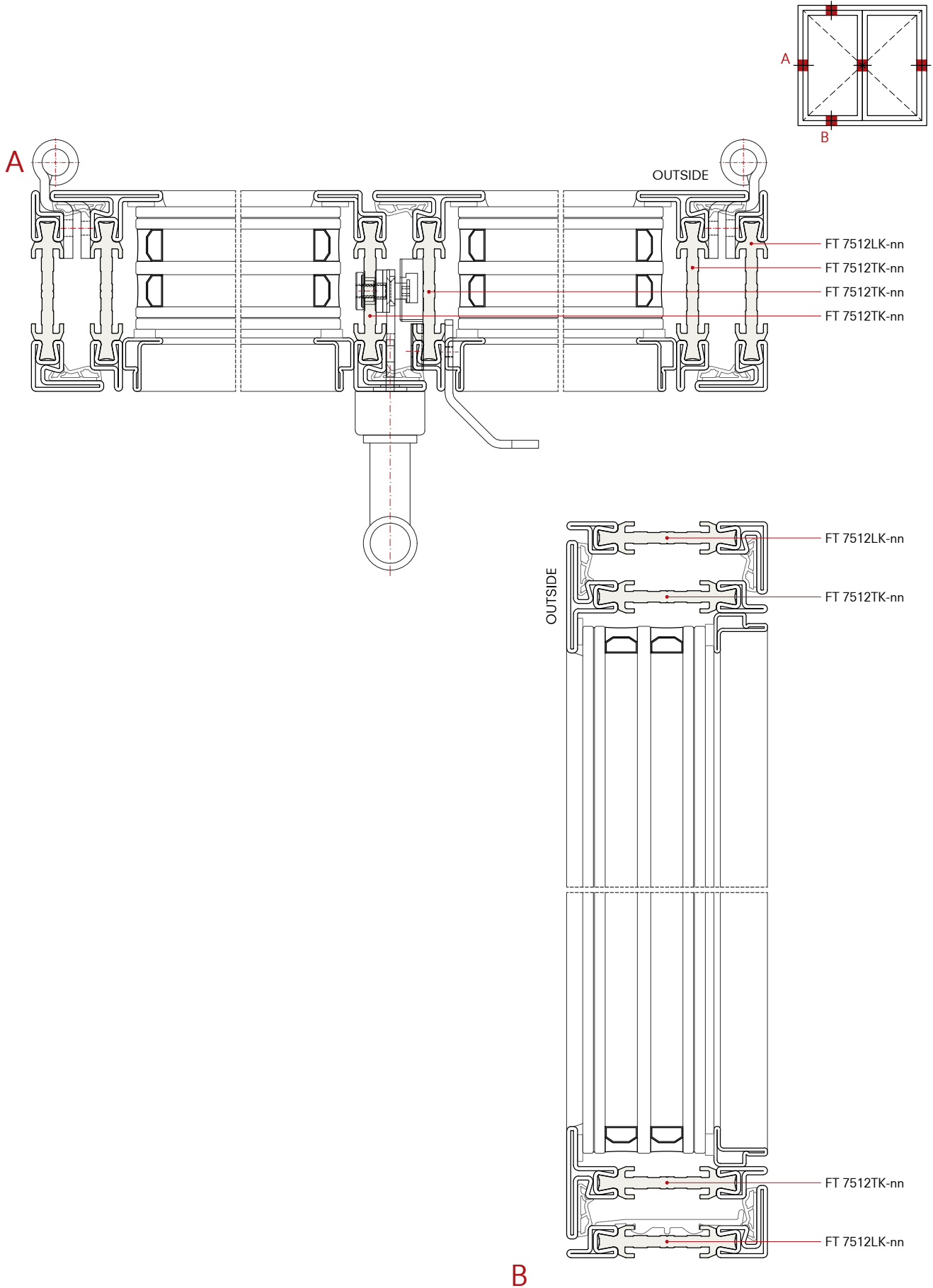

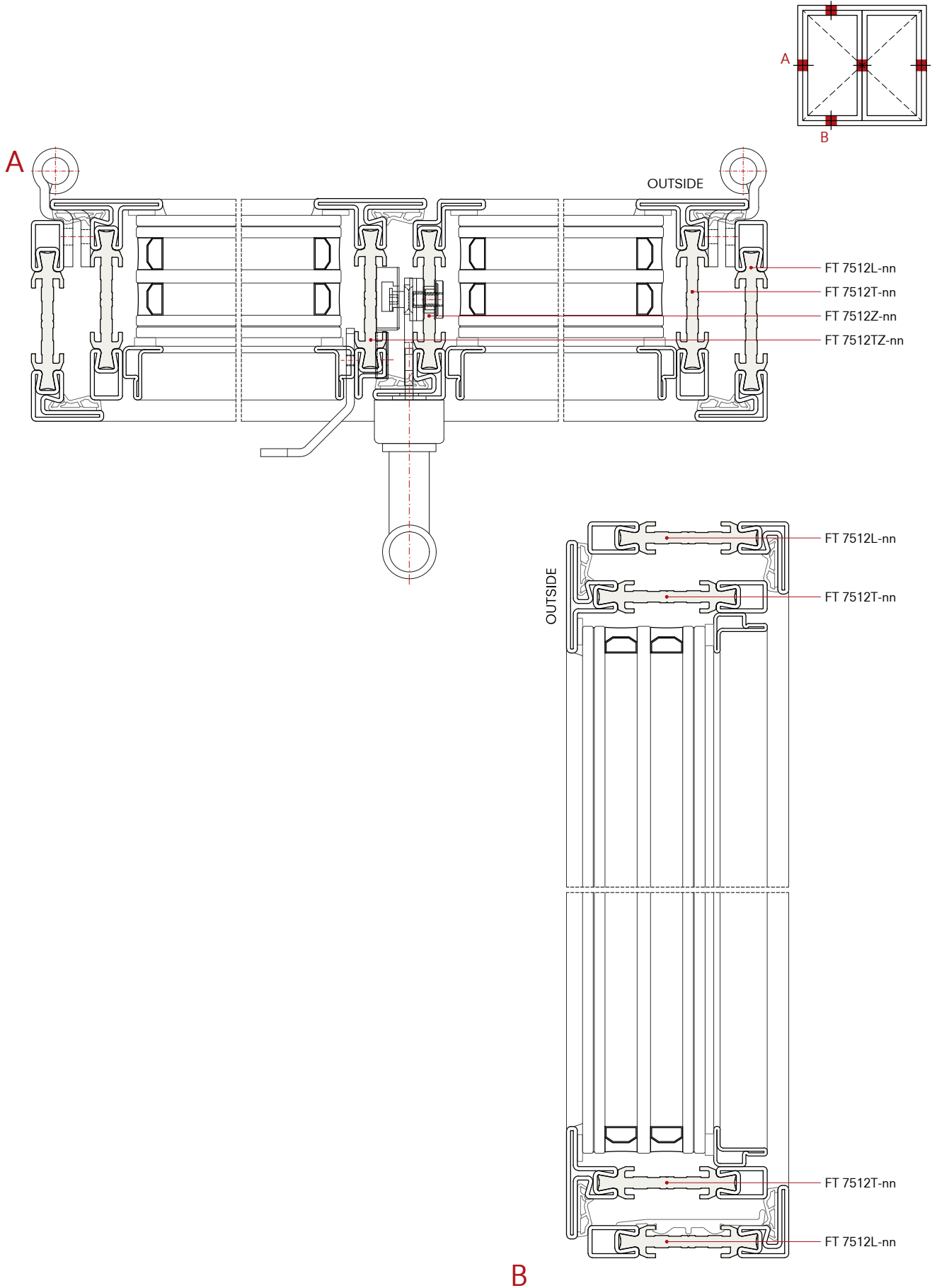

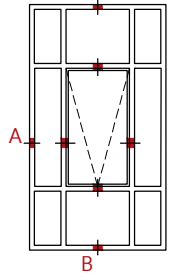

A

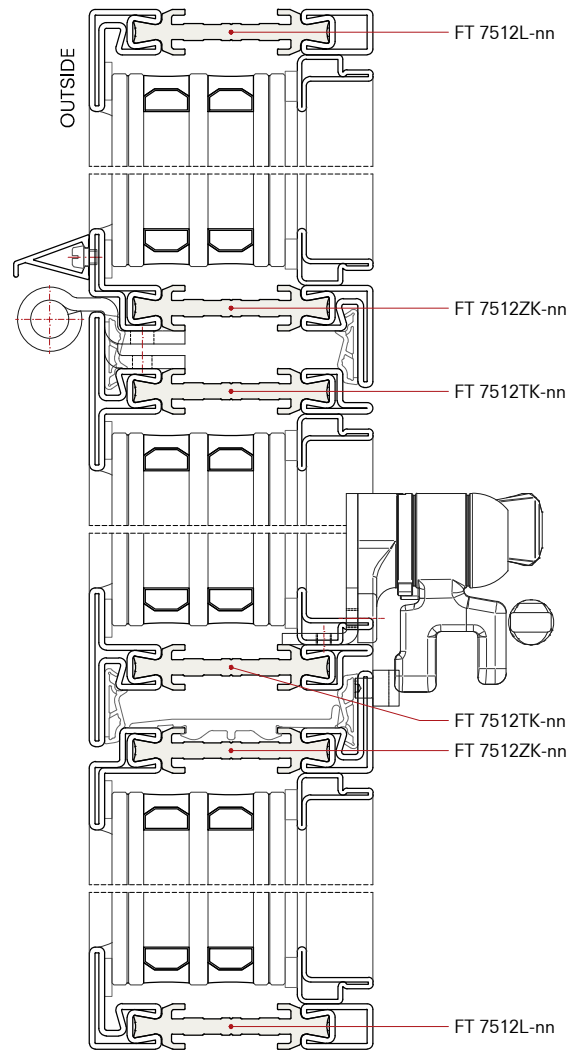
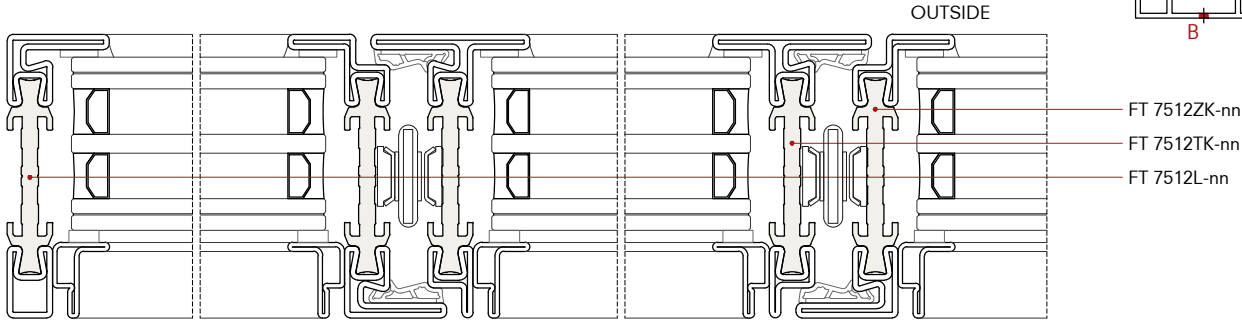

B

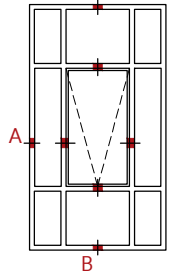

A

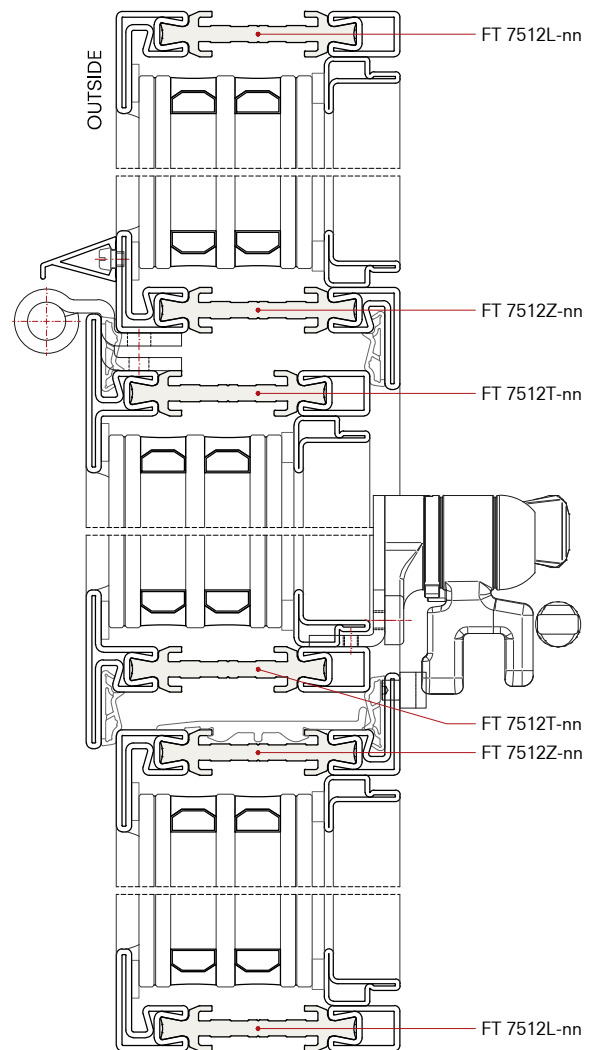
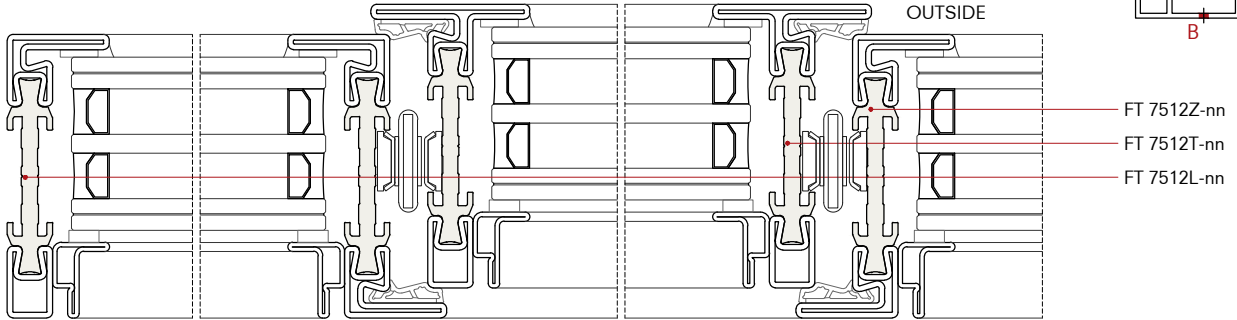

B

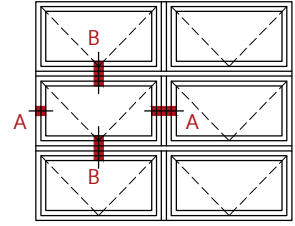

A

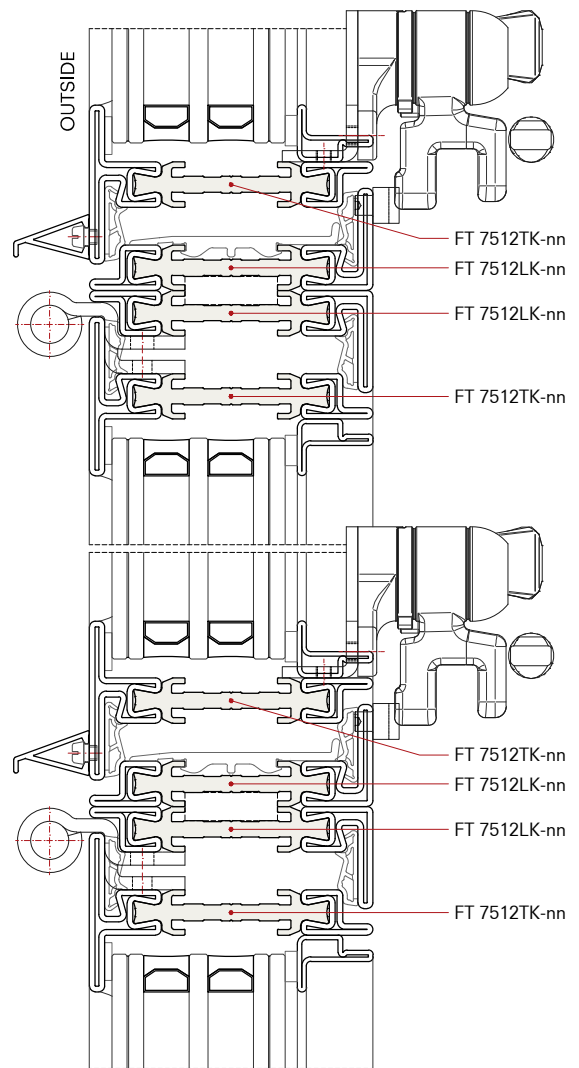
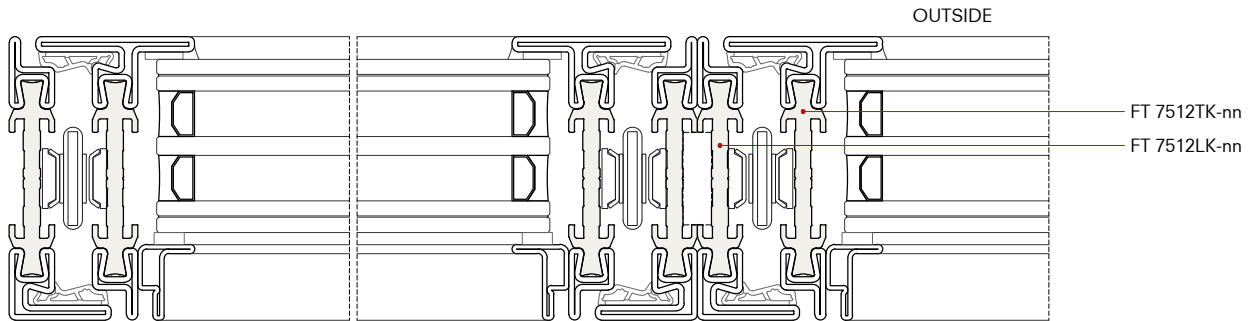

B

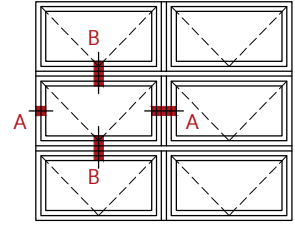

A

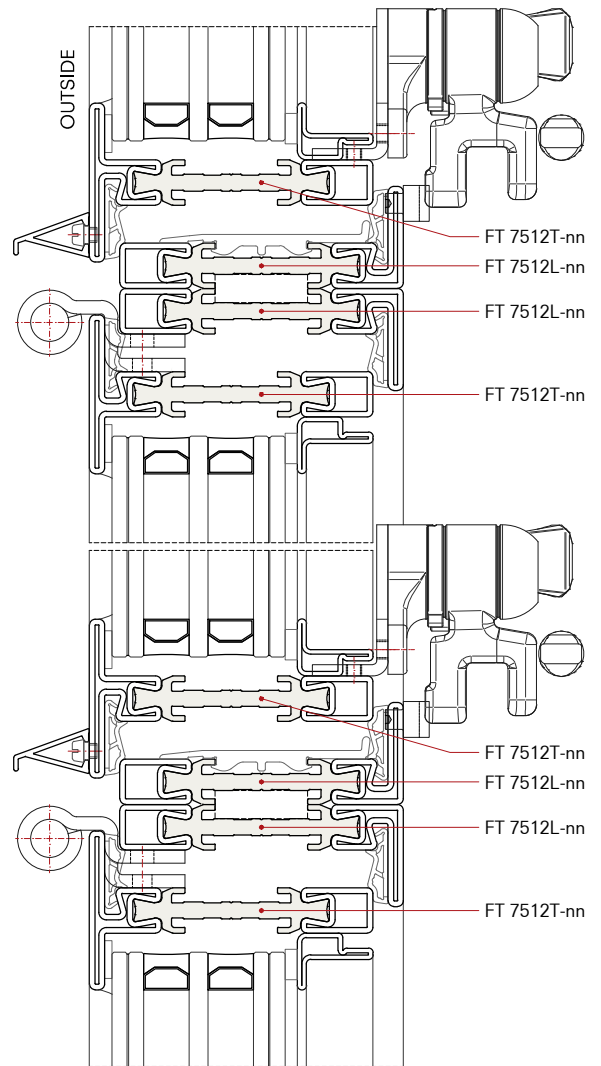
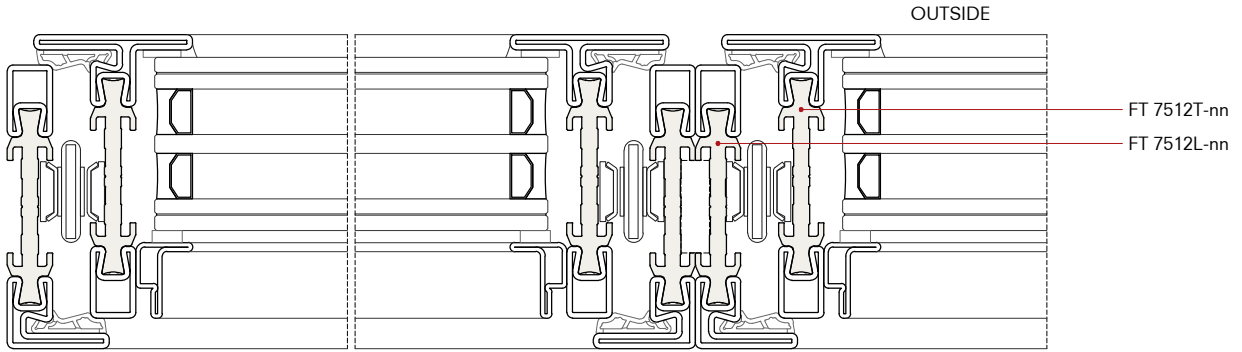

B

Profile matching

Accostamento telai

Combinación de marcos

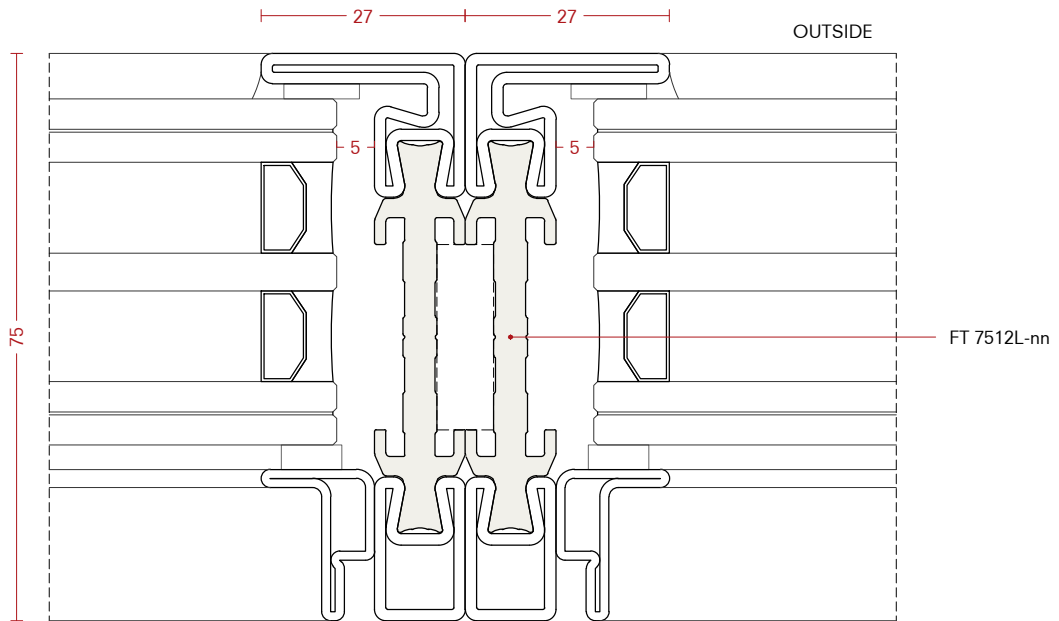
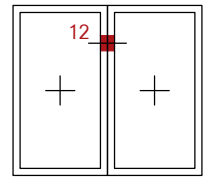

Detail 12.1

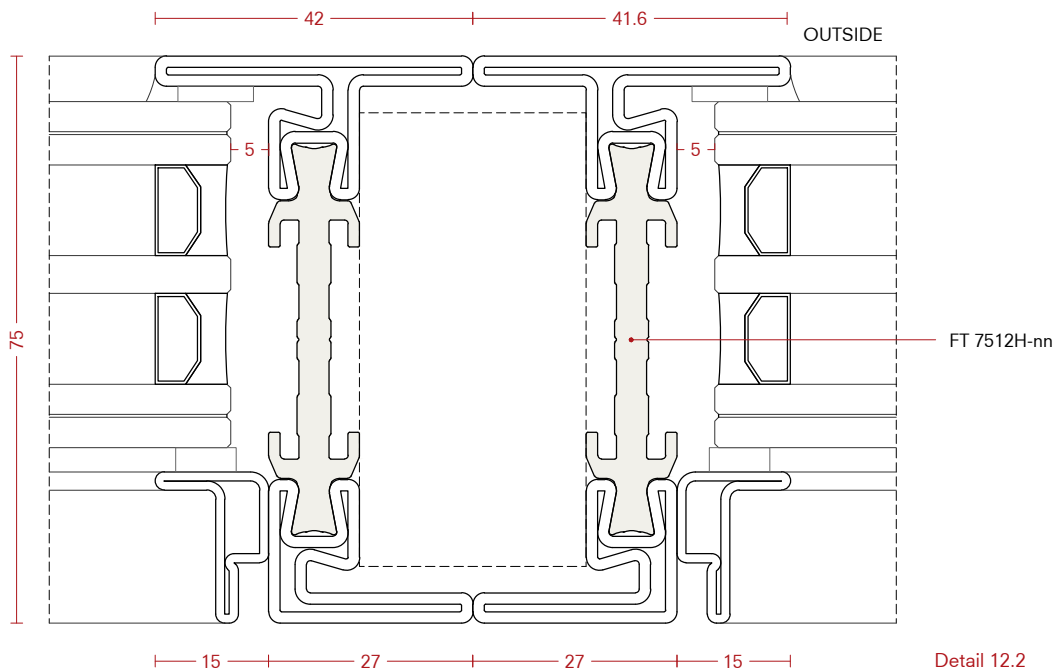

Detail 12.2

Note:

For the cutting list, consider the appropriate machining and welding tolerances in relation to the laying areas and the sealing chosen.

Nota:

Per la distinta di taglio considerare le opportune tolleranze di lavorazione e saldatura in relazione alle arie di posa e alle sigillature scelte.

Nota:

Para la lista de cortes, considere las tolerancias apropiadas de mecanizado y soldadura en relación con las áreas de colocación y los sellos elegidos.

Profile matching

Accostamento telai

Combinación de marcos

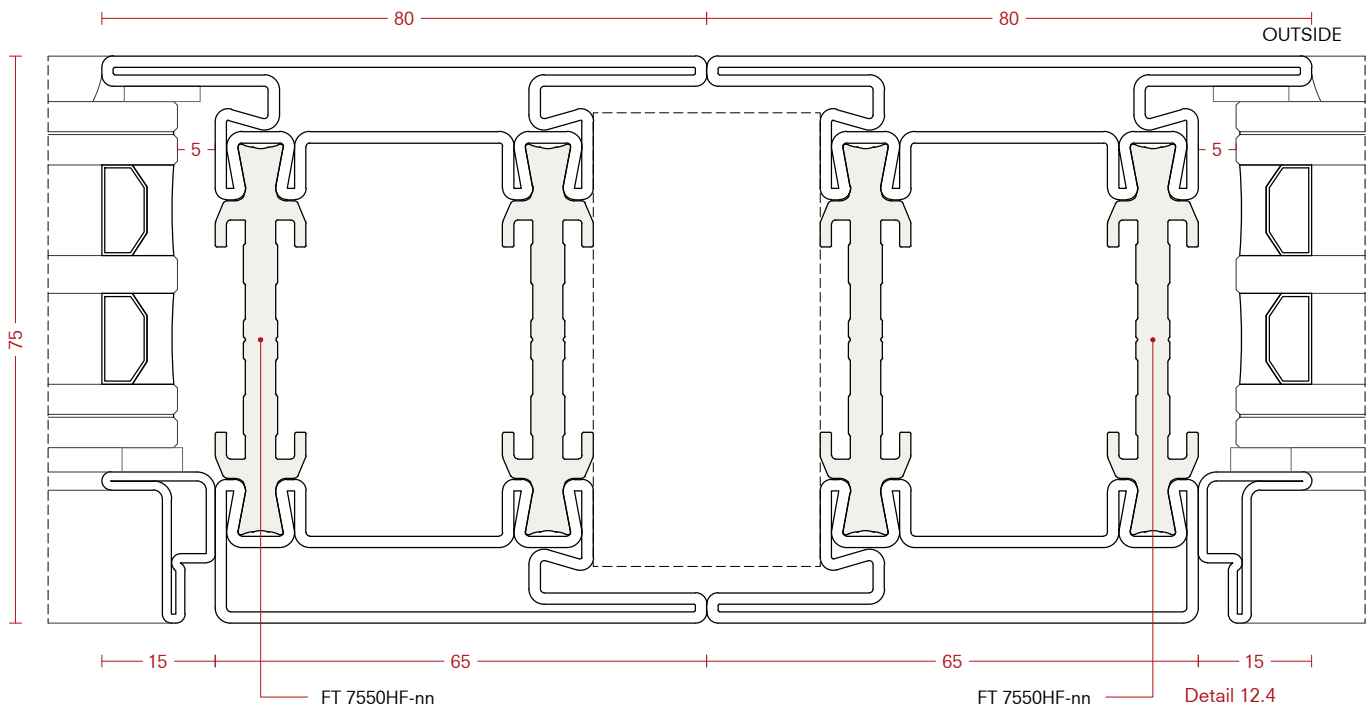
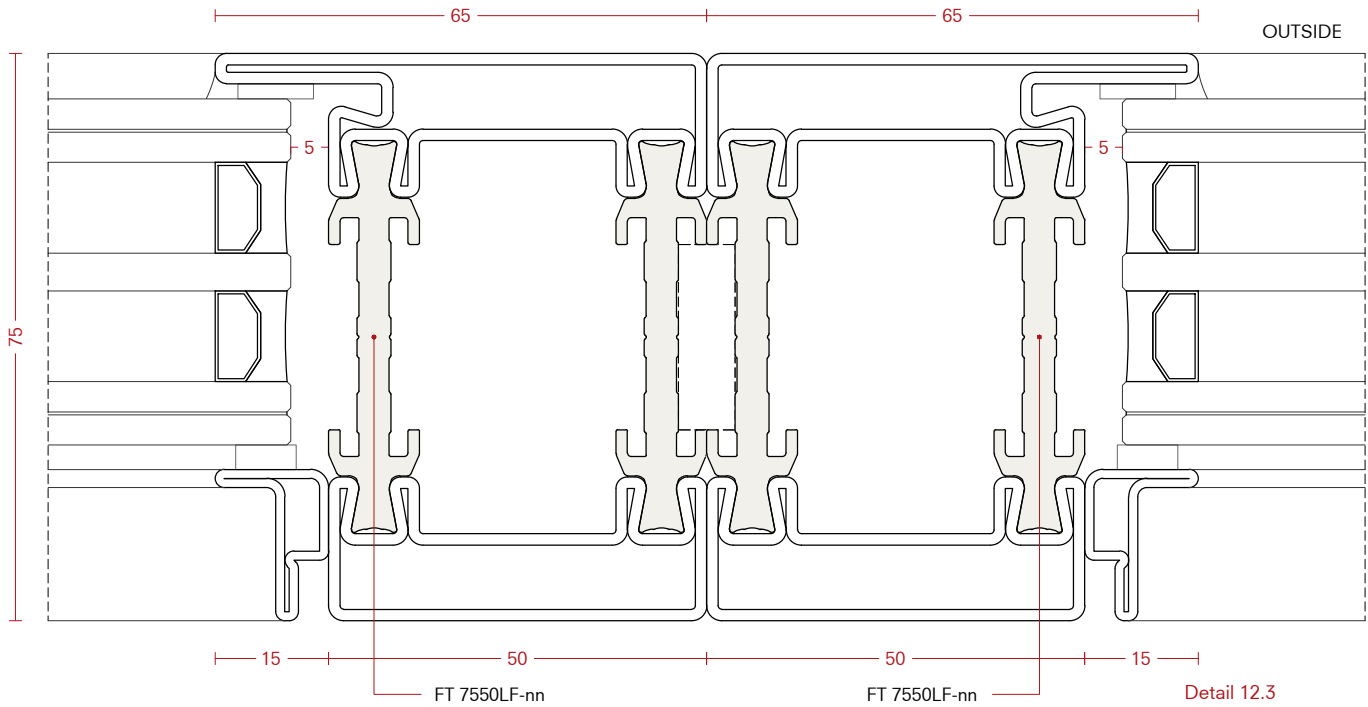
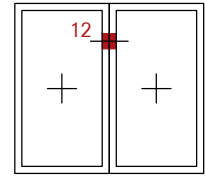

Note:

For the cutting list, consider the appropriate machining and welding tolerances in relation to the laying areas and the sealing chosen.

Nota:

Per la distinta di taglio considerare le opportune tolleranze di lavorazione e saldatura in relazione alle arie di posa e alle sigillature scelte.

Nota:

Para la lista de cortes, considere las tolerancias apropiadas de mecanizado y soldadura en relación con las áreas de colocación y los sellos elegidos.

Profile matching

Accostamento telai

Combinación de marcos

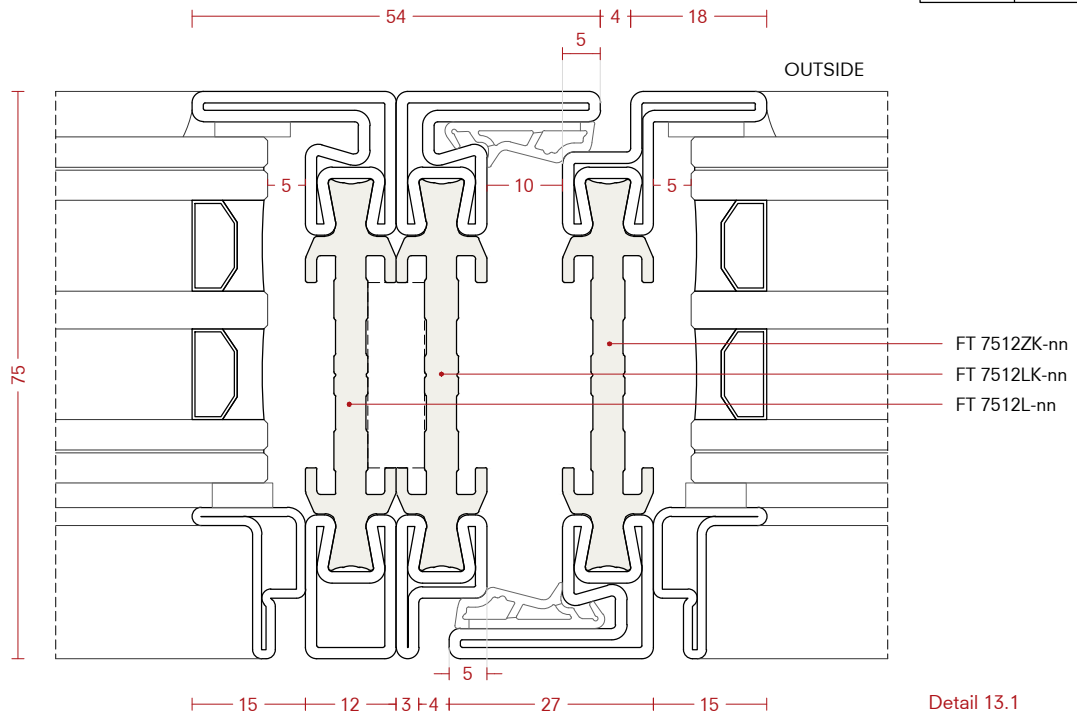
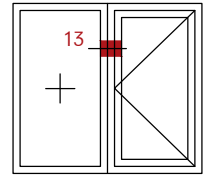

Detail 13.1

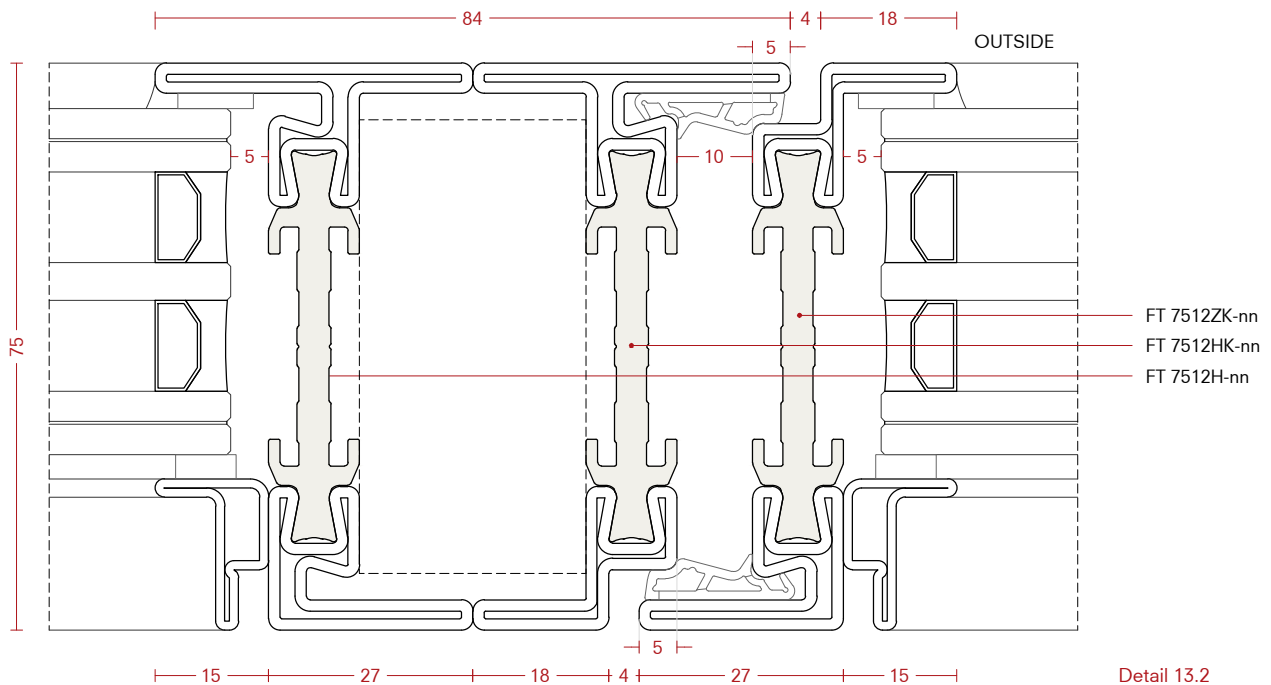

Detail 13.2

Note:

For the cutting list, consider the appropriate machining and welding tolerances in relation to the laying areas and the sealing chosen.

Nota:

Per la distinta di taglio considerare le opportune tolleranze di lavorazione e saldatura in relazione alle arie di posa e alle sigillature scelte.

Nota:

Para la lista de cortes, considere las tolerancias apropiadas de mecanizado y soldadura en relación con las áreas de colocación y los sellos elegidos.

Profile matching

Accostamento telai

Combinación de marcos

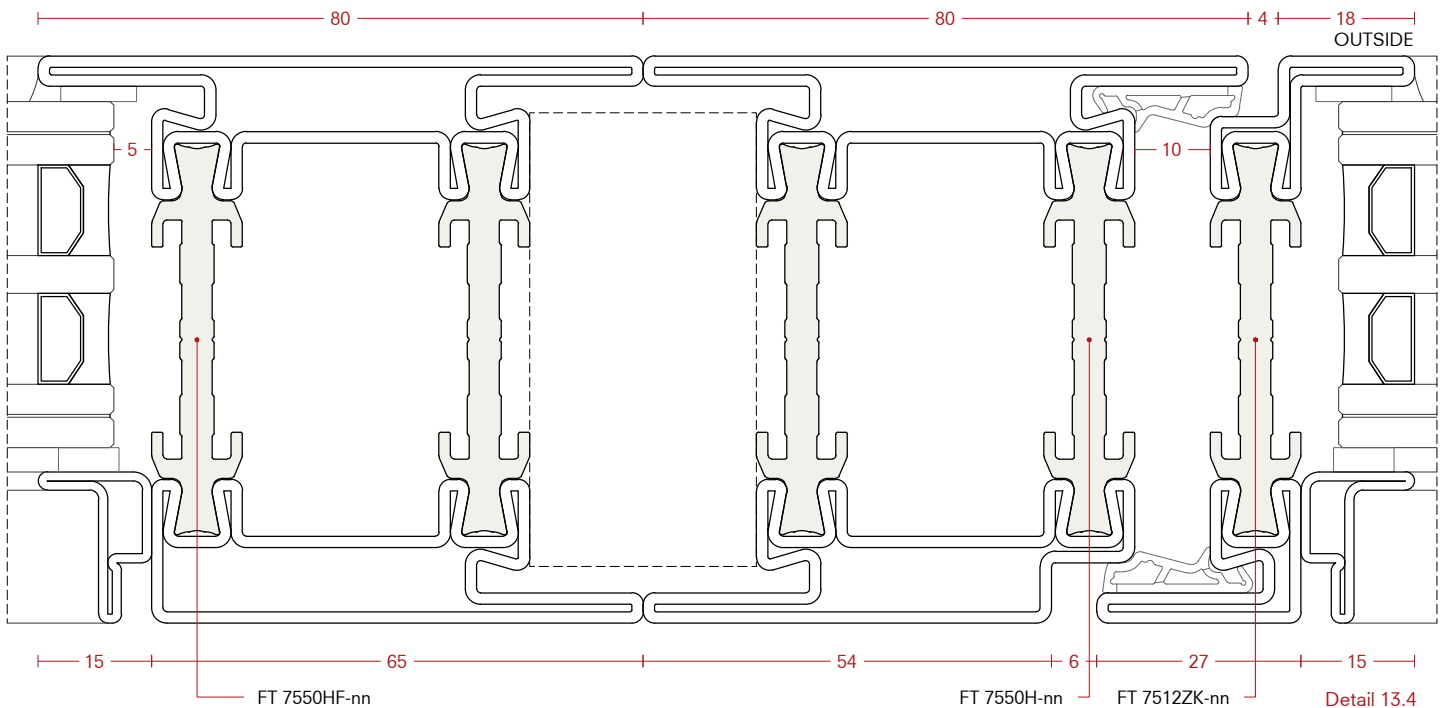
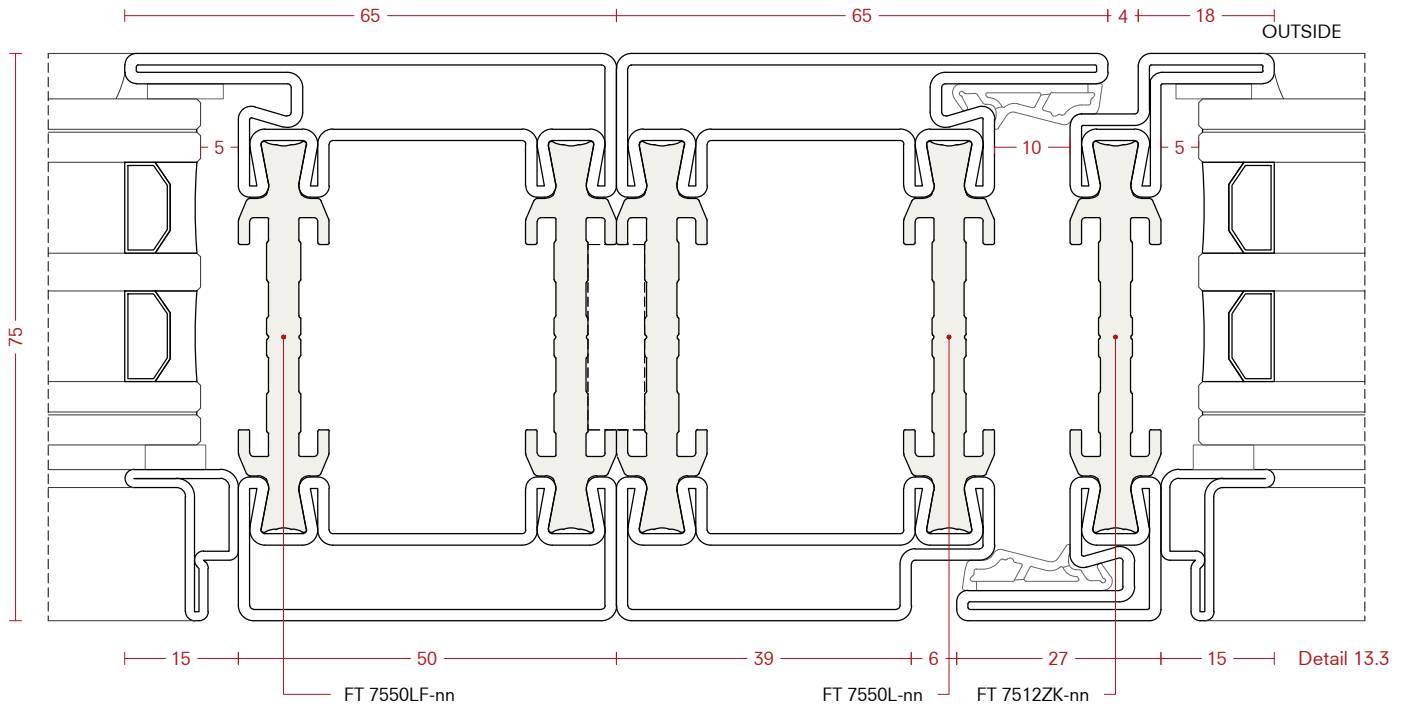
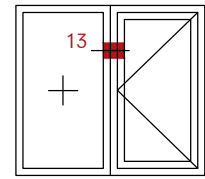

Note:

For the cutting list, consider the appropriate machining and welding tolerances in relation to the laying areas and the sealing chosen.

Nota:

Per la distinta di taglio considerare le opportune tolleranze di lavorazione e saldatura in relazione alle arie di posa e alle sigillature scelte.

Nota:

Para la lista de cortes, considere las tolerancias apropiadas de mecanizado y soldadura en relación con las áreas de colocación y los sellos elegidos.

Profile matching

Accostamento telai

Combinación de marcos

Note:

For the cutting list, consider the relevant machining and welding tolerances taking into account the necessary gaps in the installation of frames and the chosen sealing.

Nota:

Per la distinta di taglio, considerare le corrette tolleranze di lavorazione e saldatura, in relazione all'aria necessaria nell'installazione e alla sigillatura scelta.

Nota:

Para la lista de cortes, considere las correctas tolerancias de mecanizado y soldadura, en relación al aire requerido en la instalación y el sello elegido.

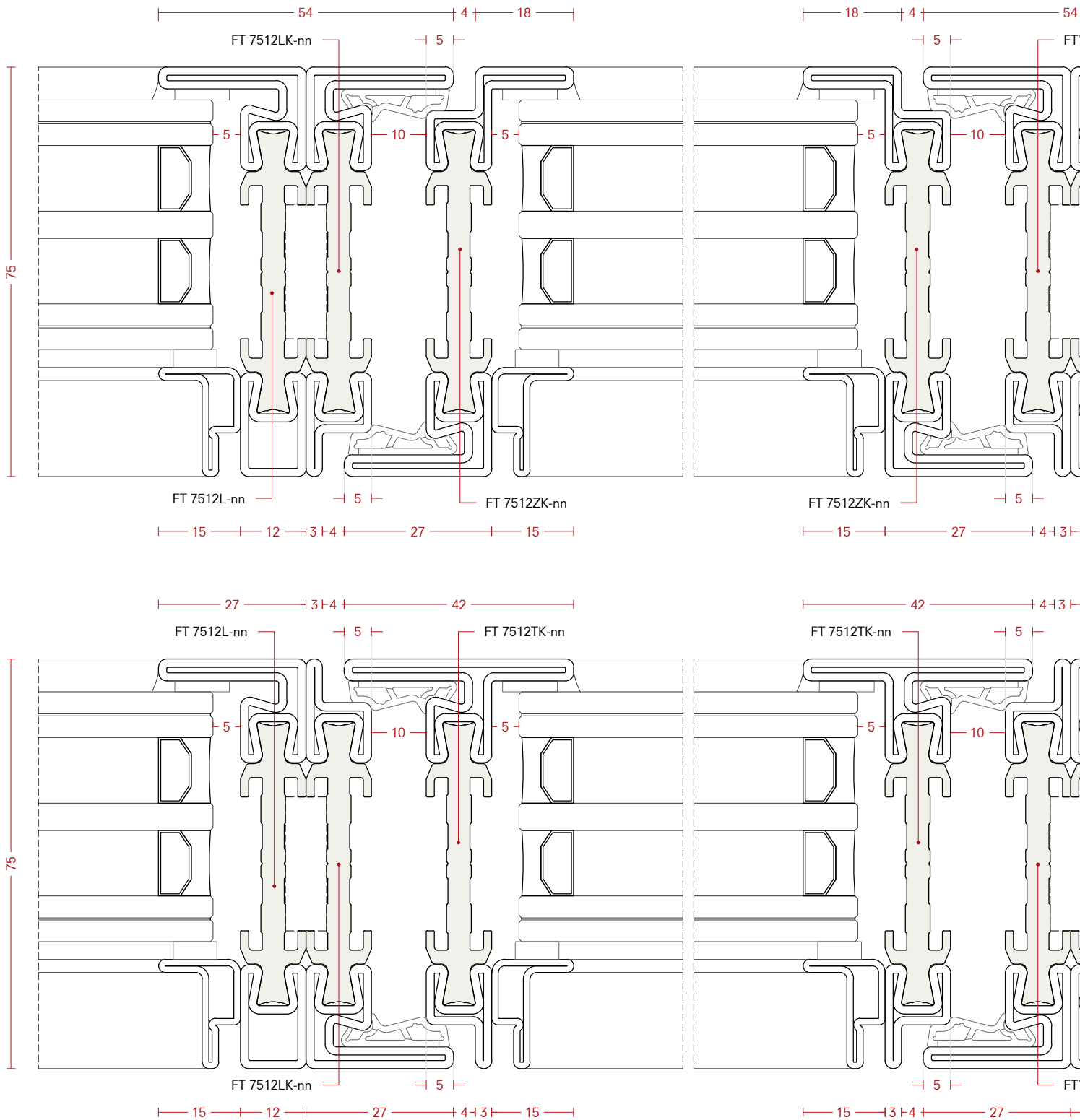

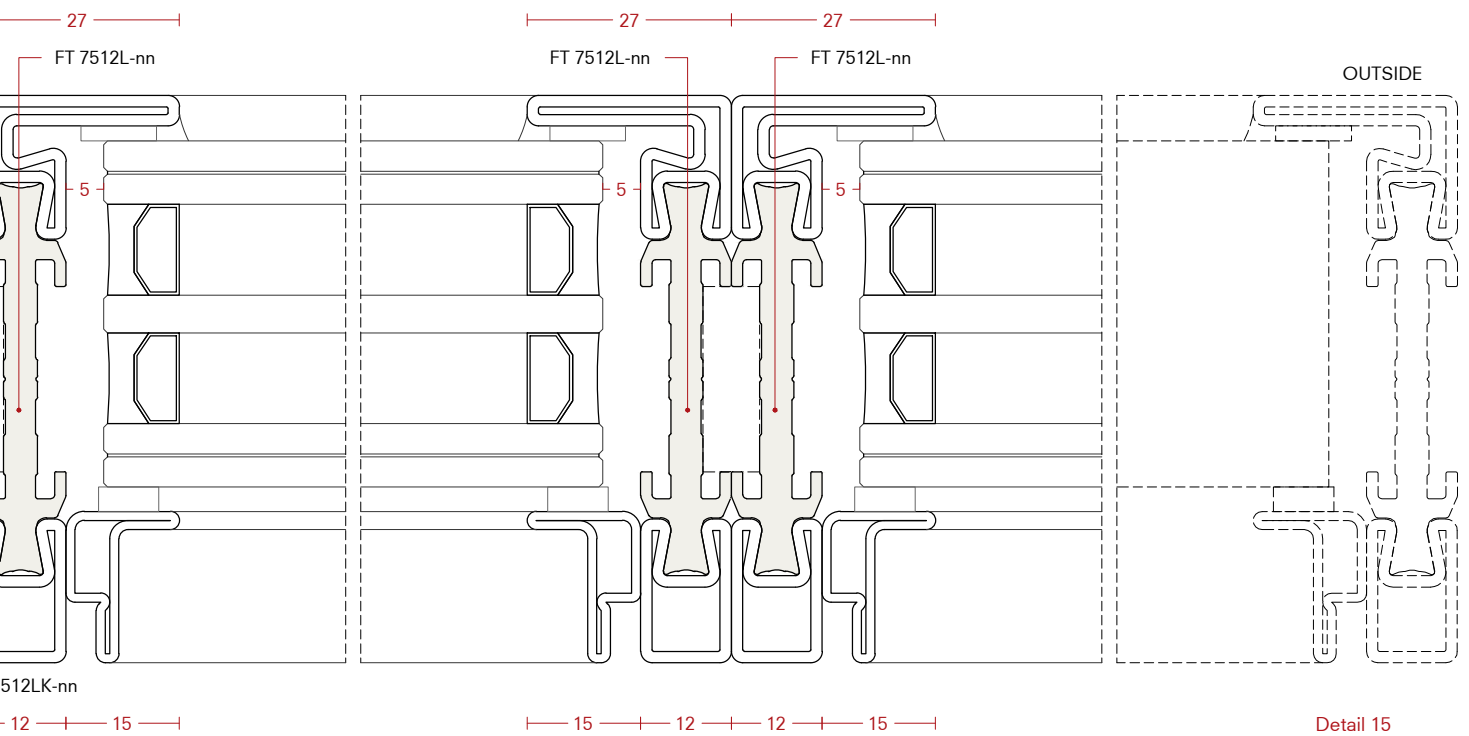
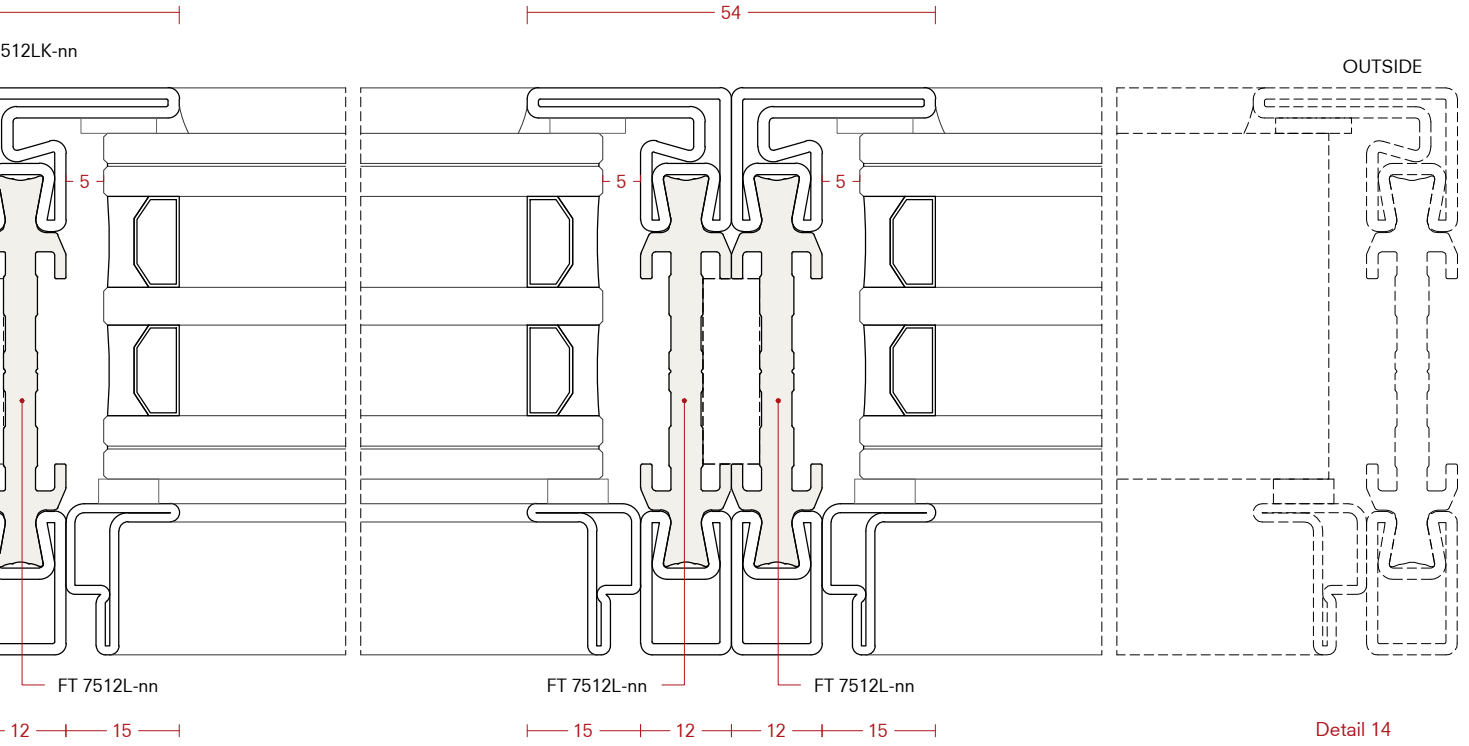
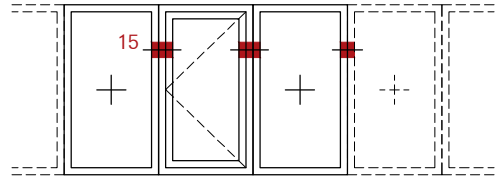
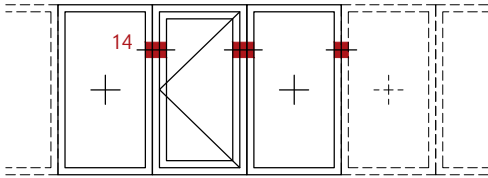

Door details

Sezioni porte

Detalles de puertas

4.2

Legend

+ = Fixed
— = Open in
- - - = Open out
Dimensions in: mm
Scale 1:1 - 1:2

Legenda

+ = Anta fissa
— = Apertura interna
- - - = Apertura esterna
Misure in: mm
Scala 1:1 - 1:2

Leyenda

+ = Fijo
— = Apertura interna
- - - = Apertura externa
Medidas en: mm
Escala 1:1 - 1:2

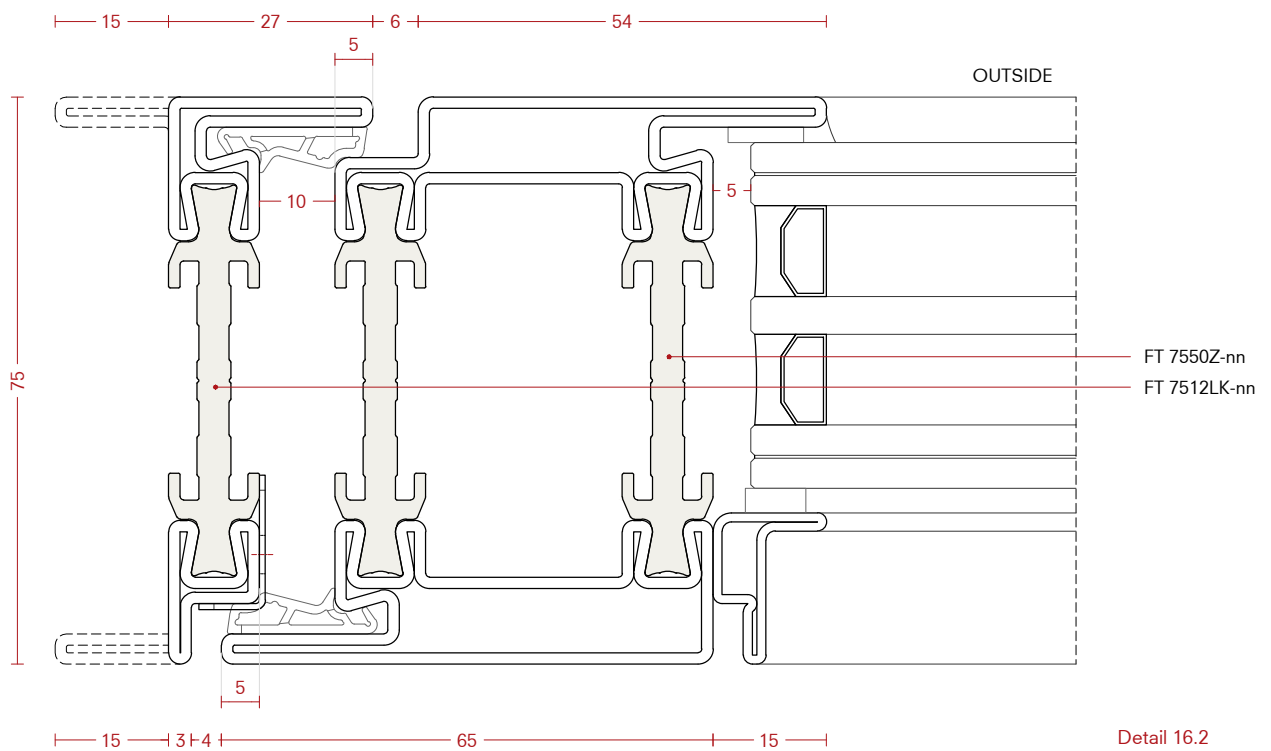
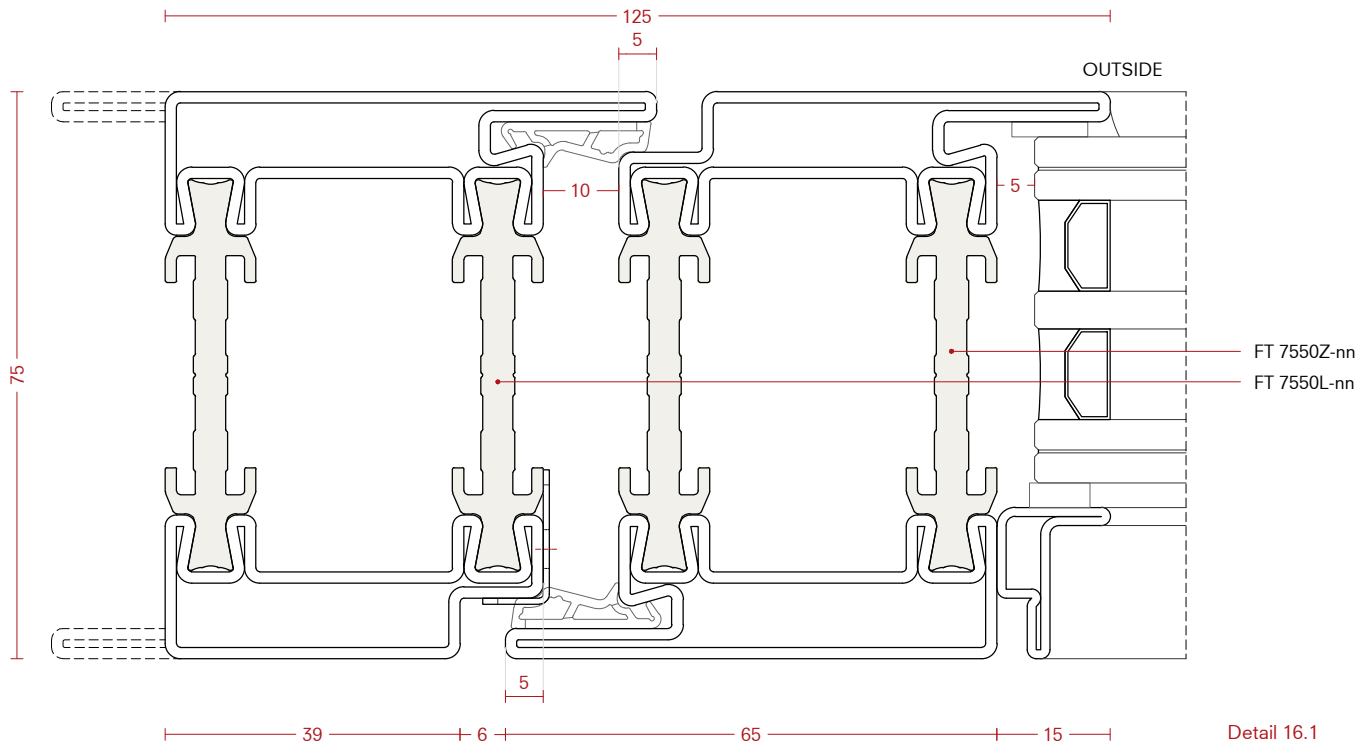
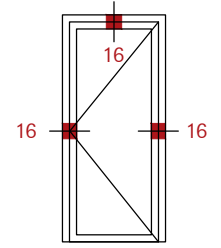

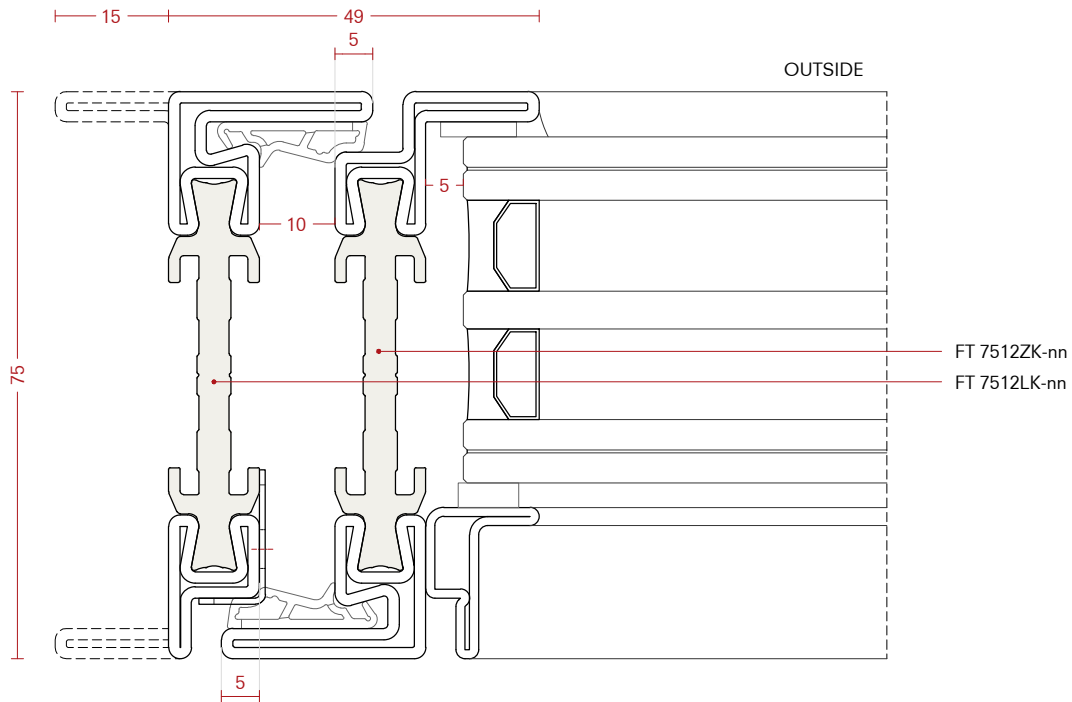
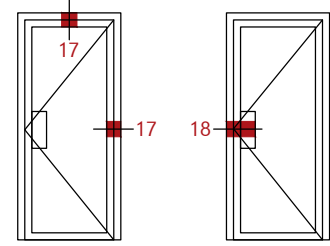

Detail 17

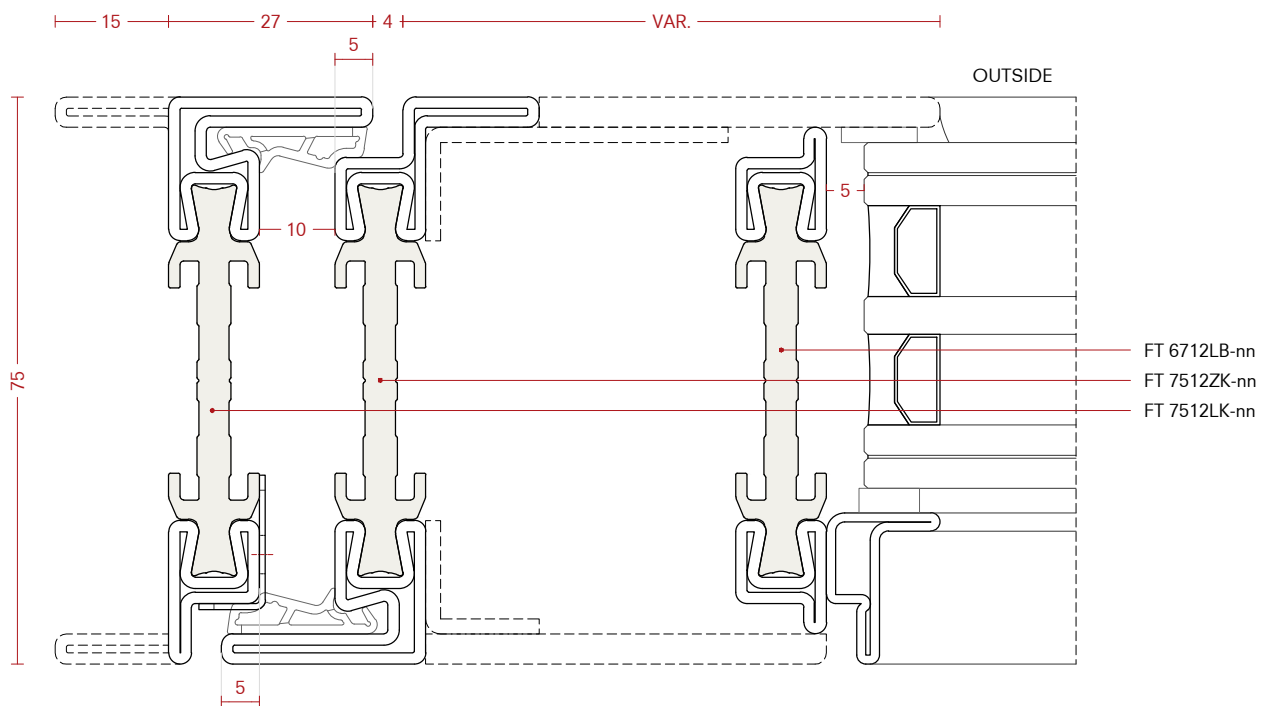

Detail 18

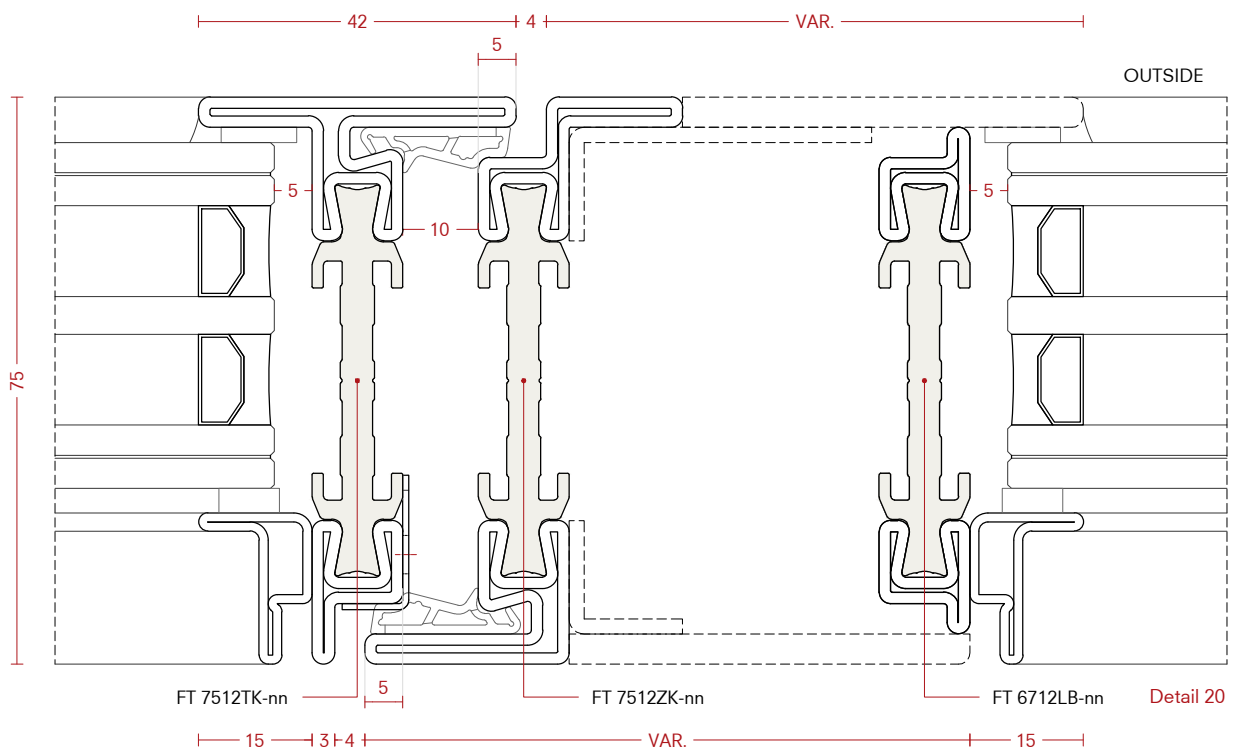
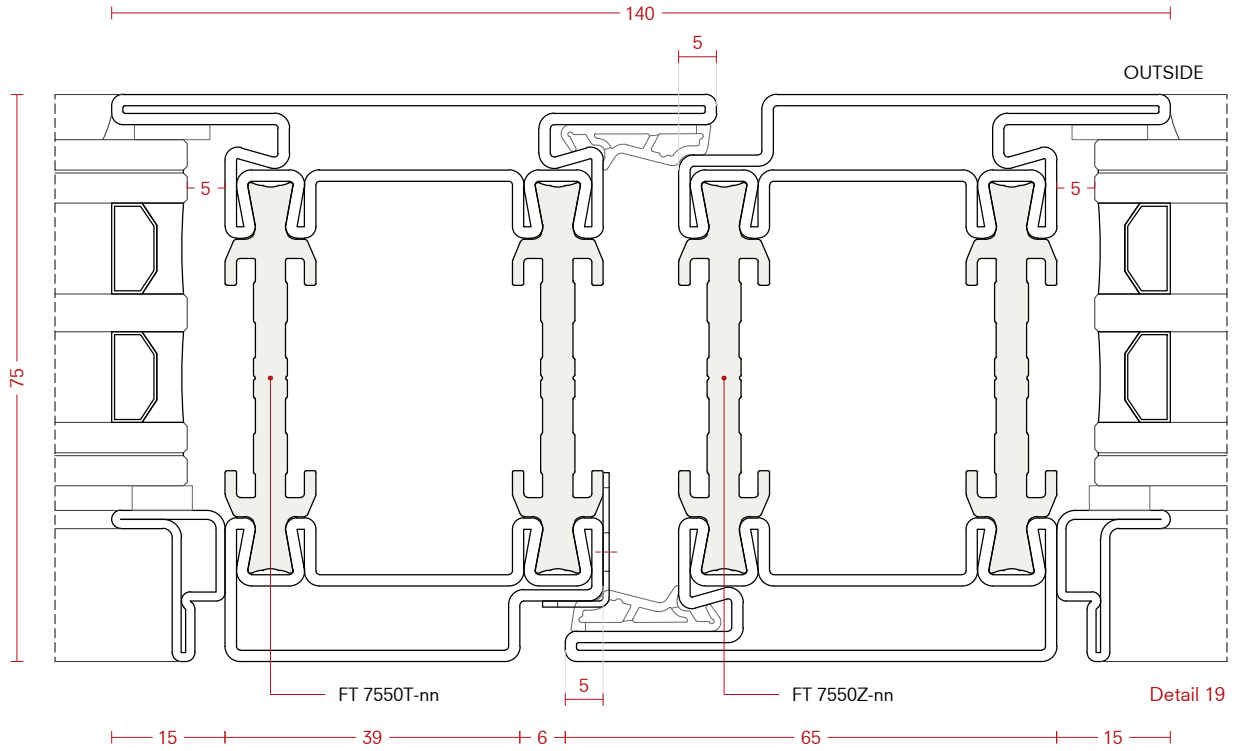
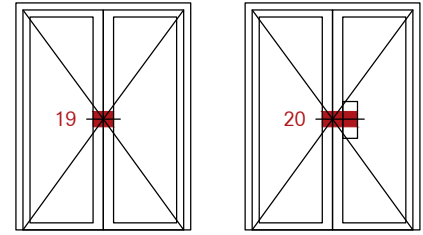

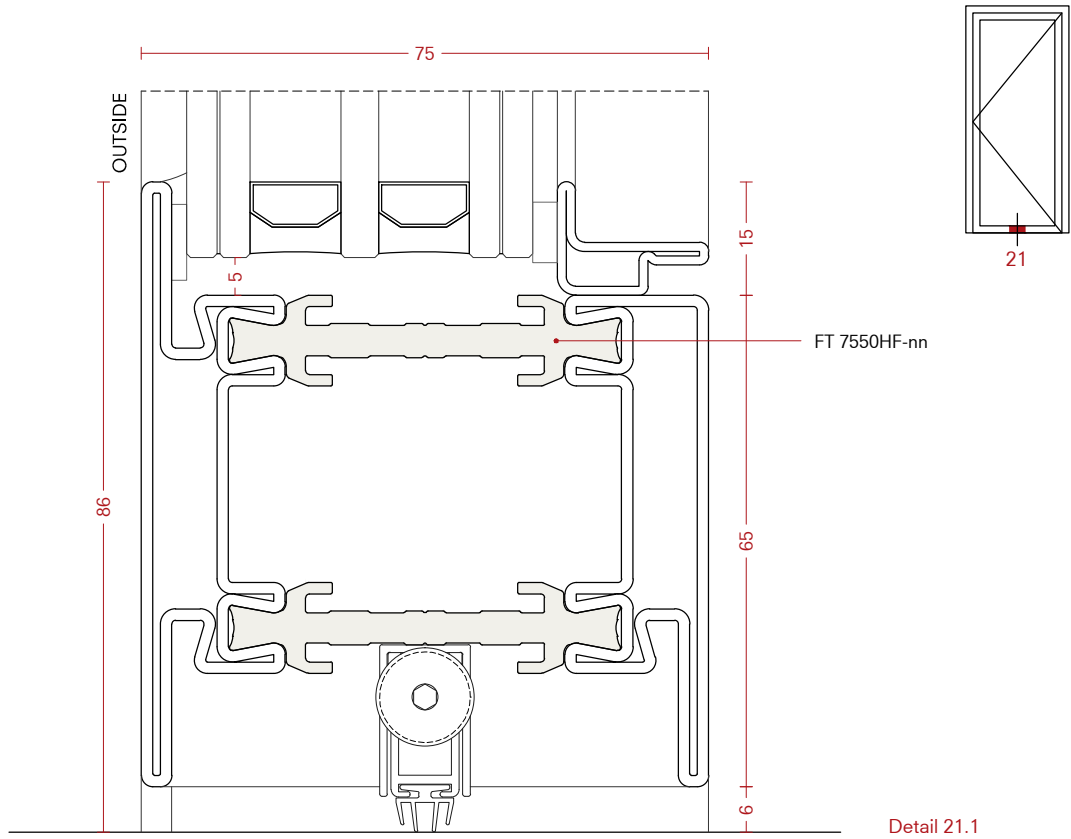

Detail 21.1

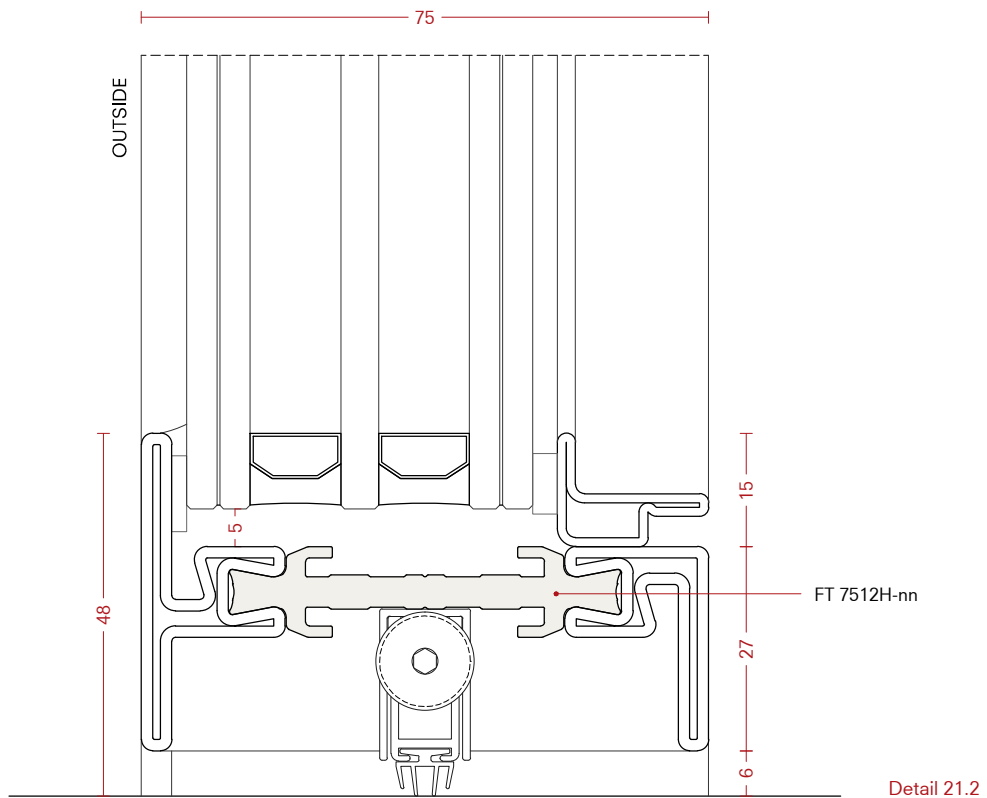

Detail 21.2

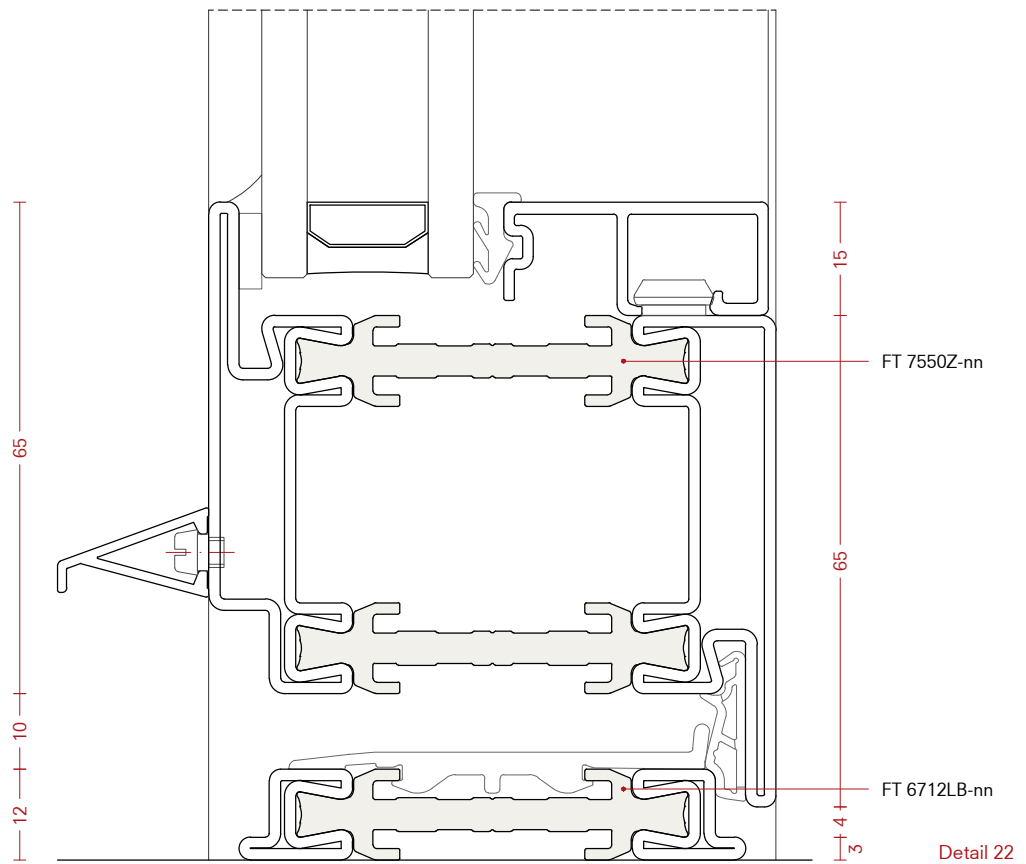
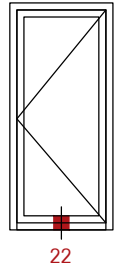

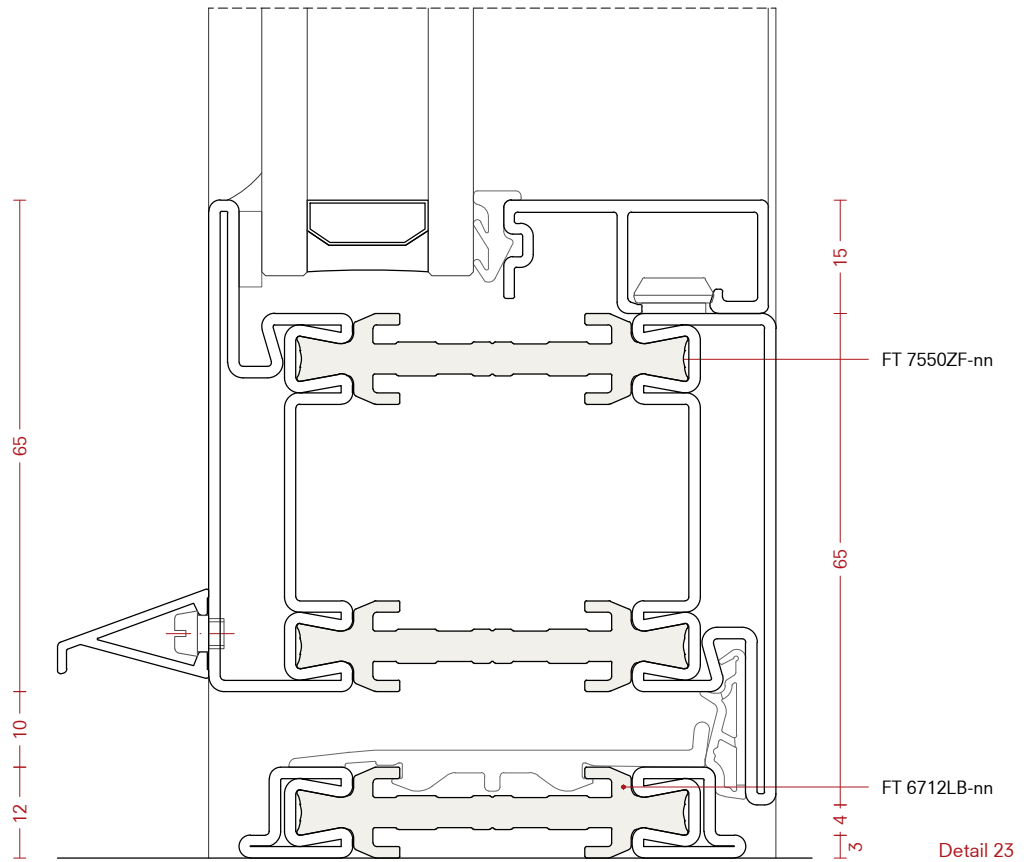
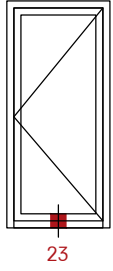

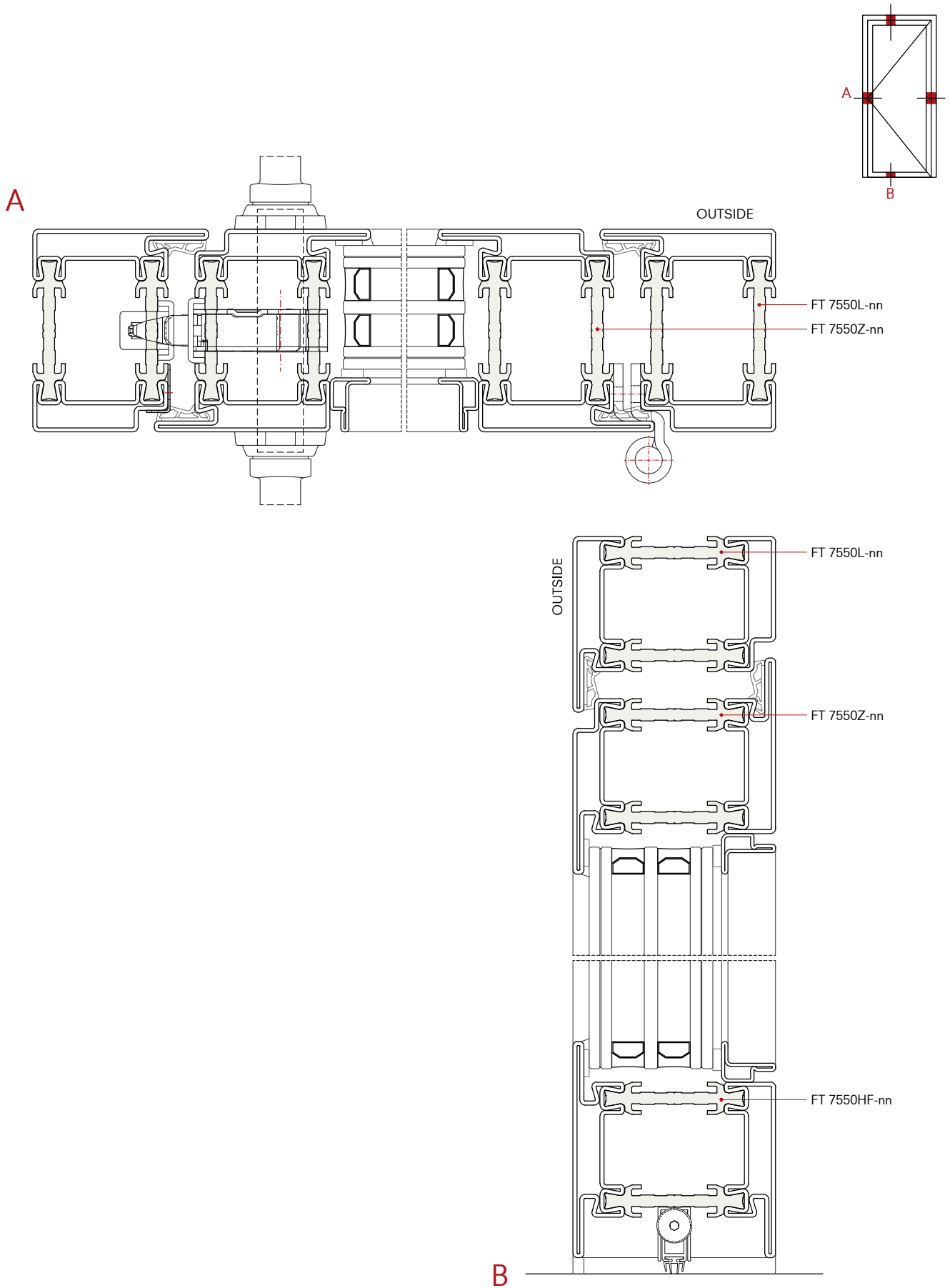

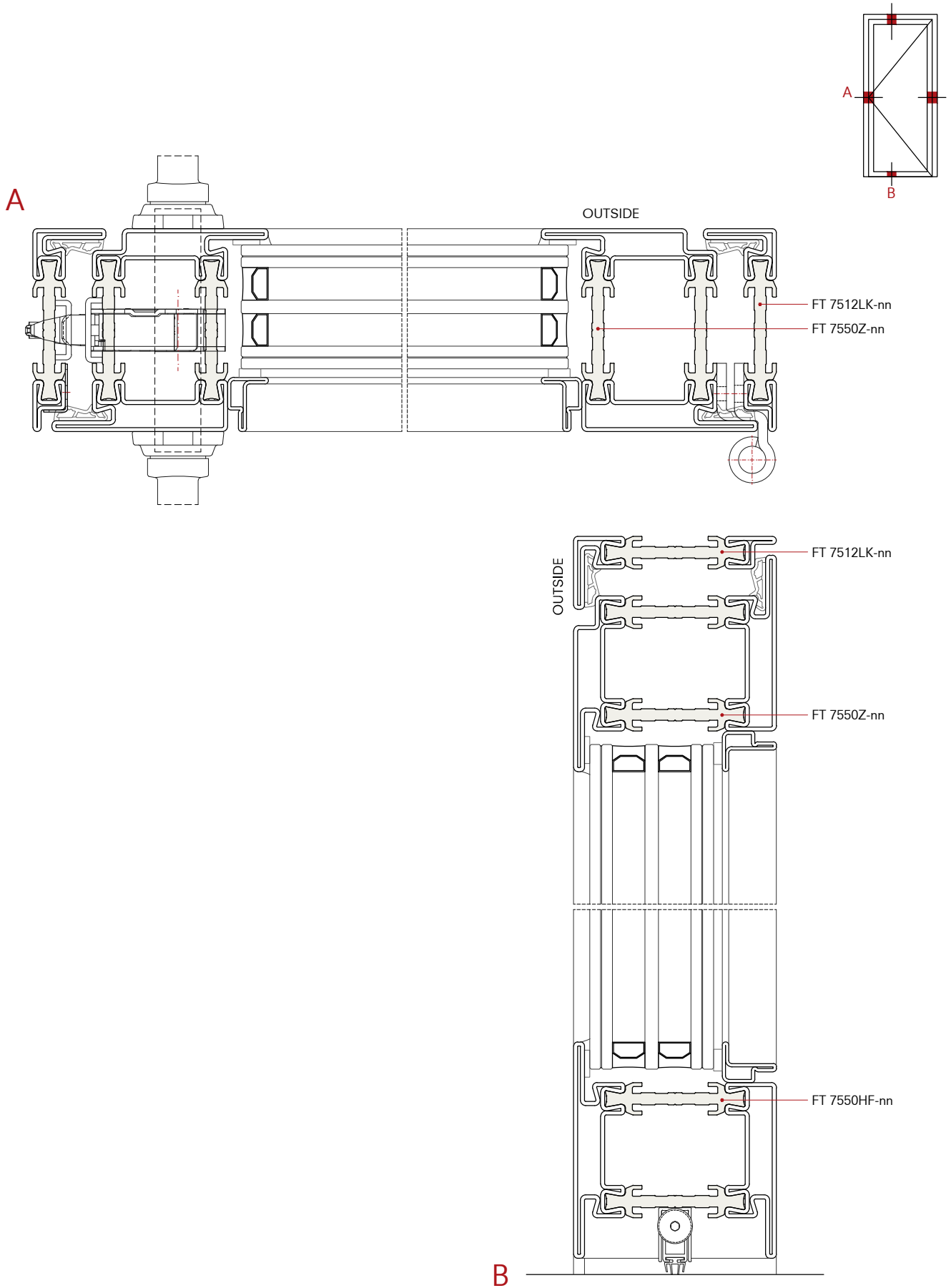

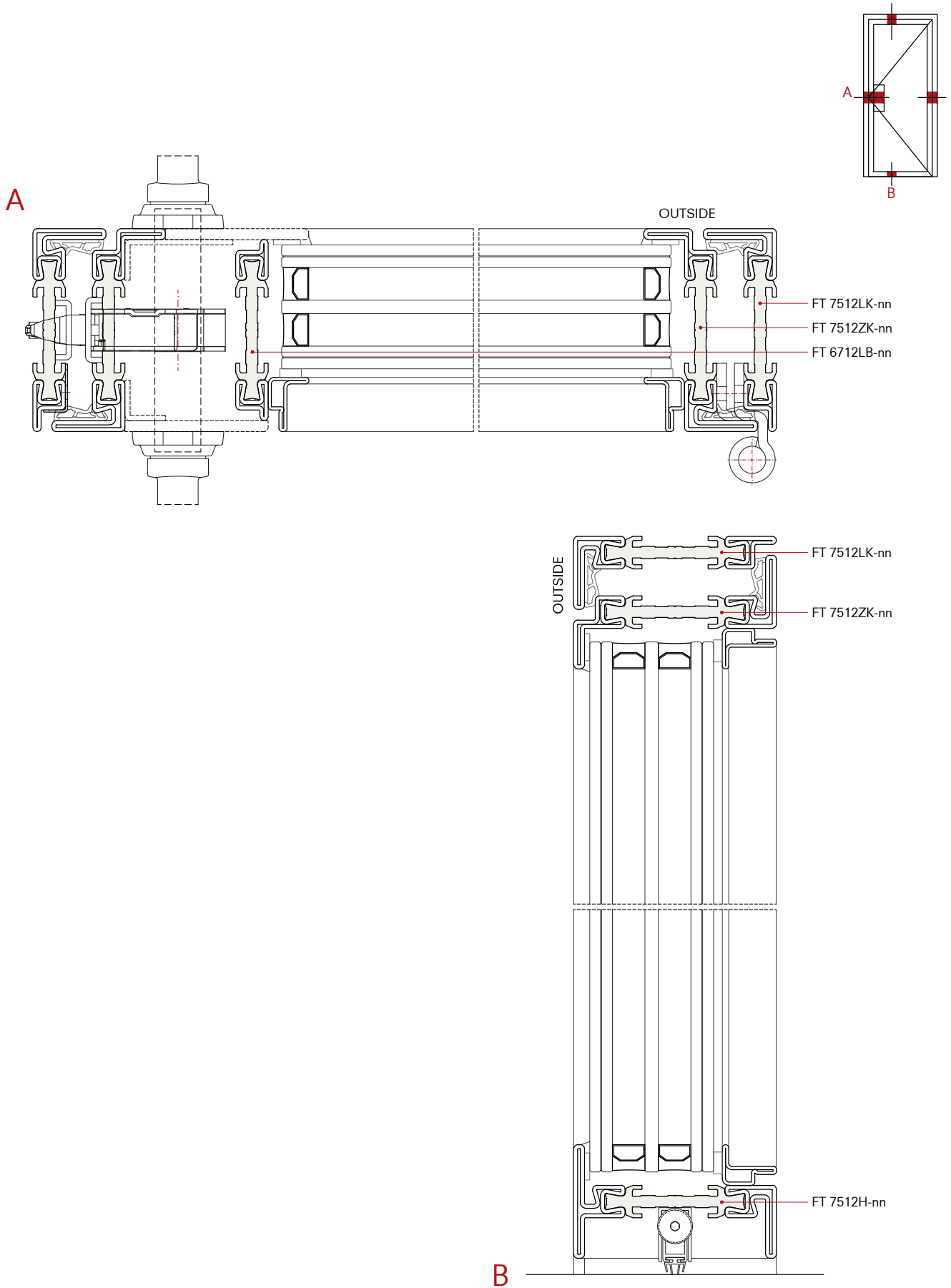

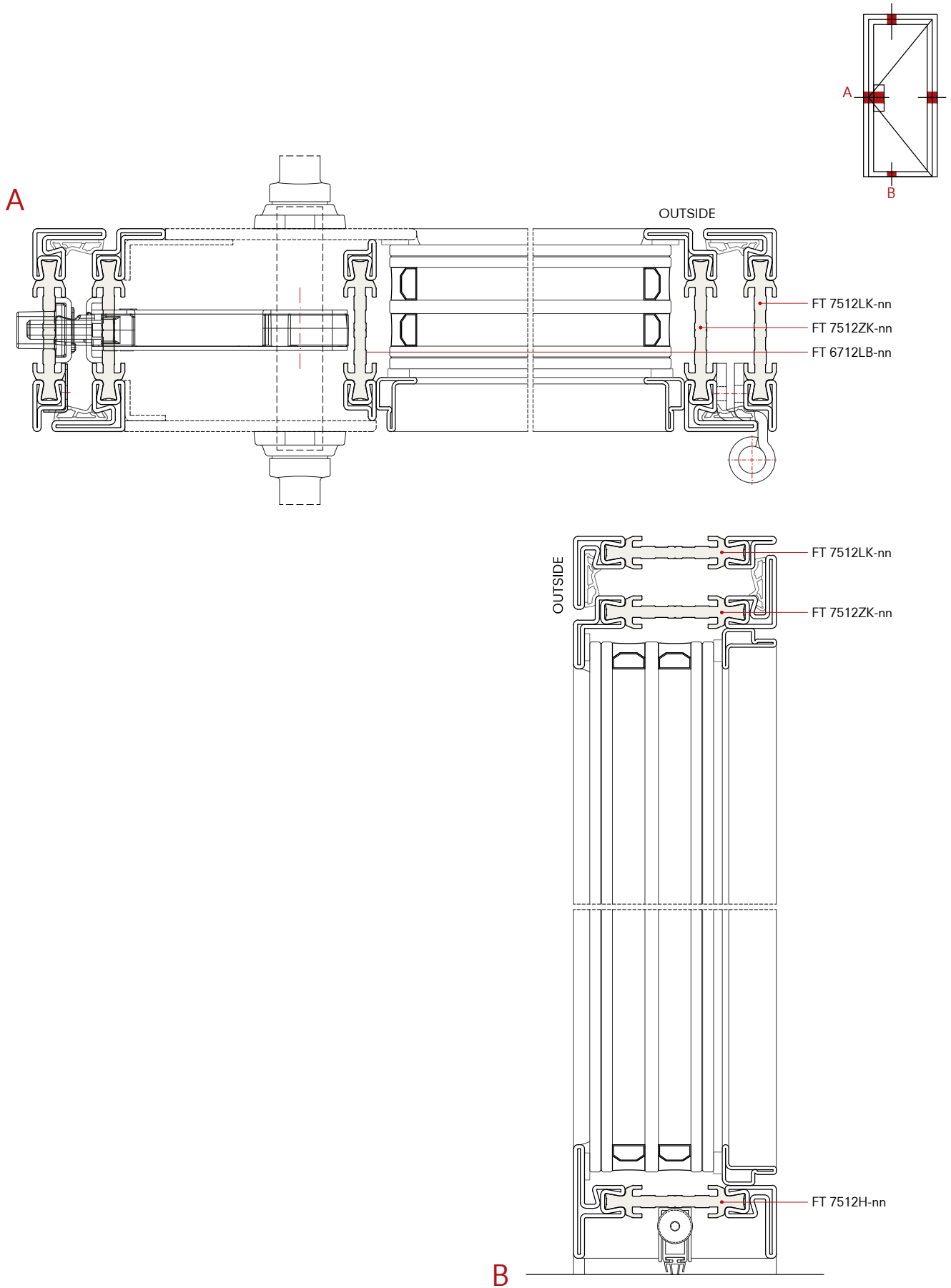

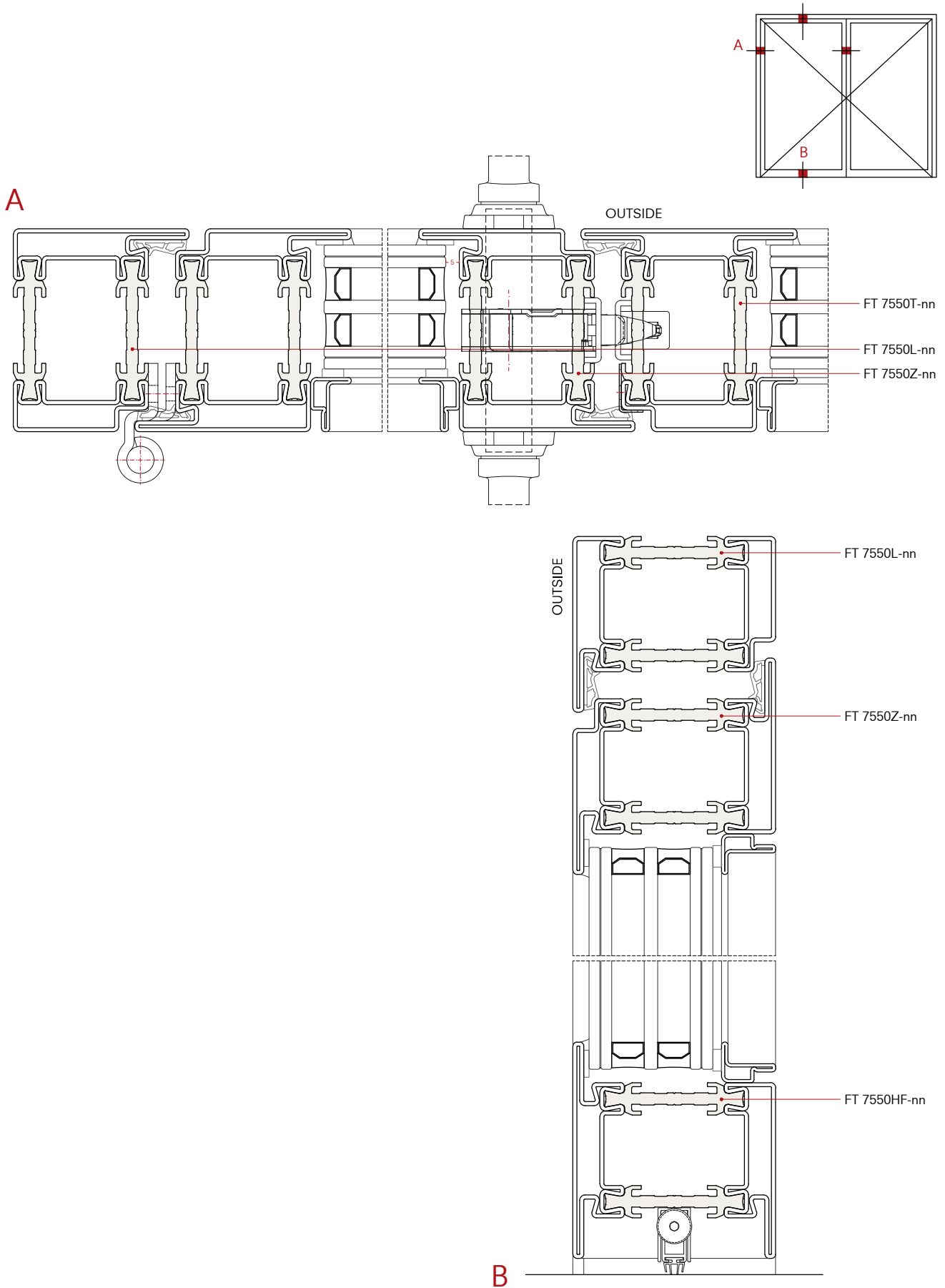

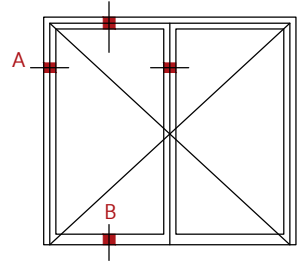

A

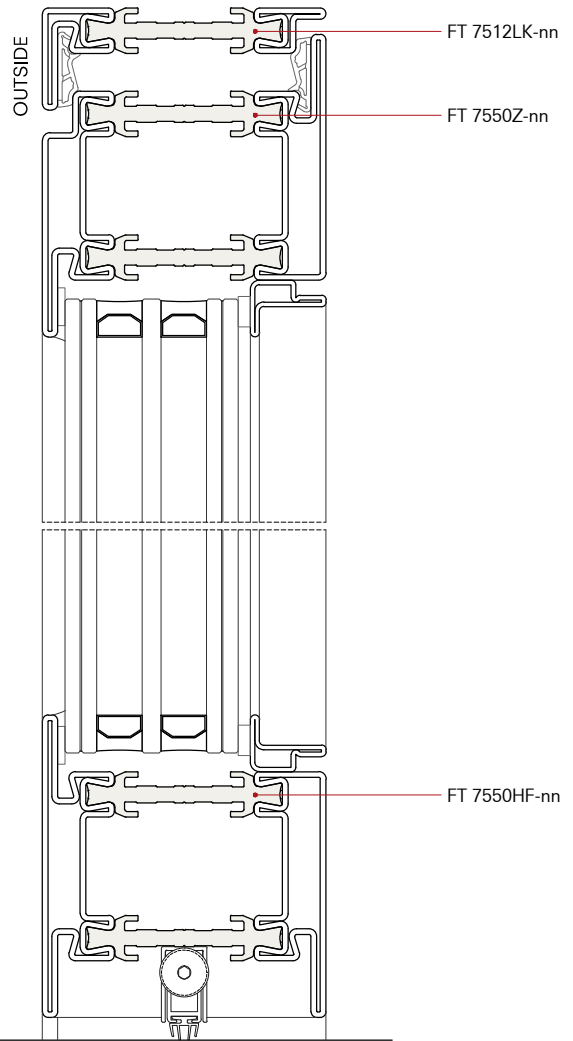
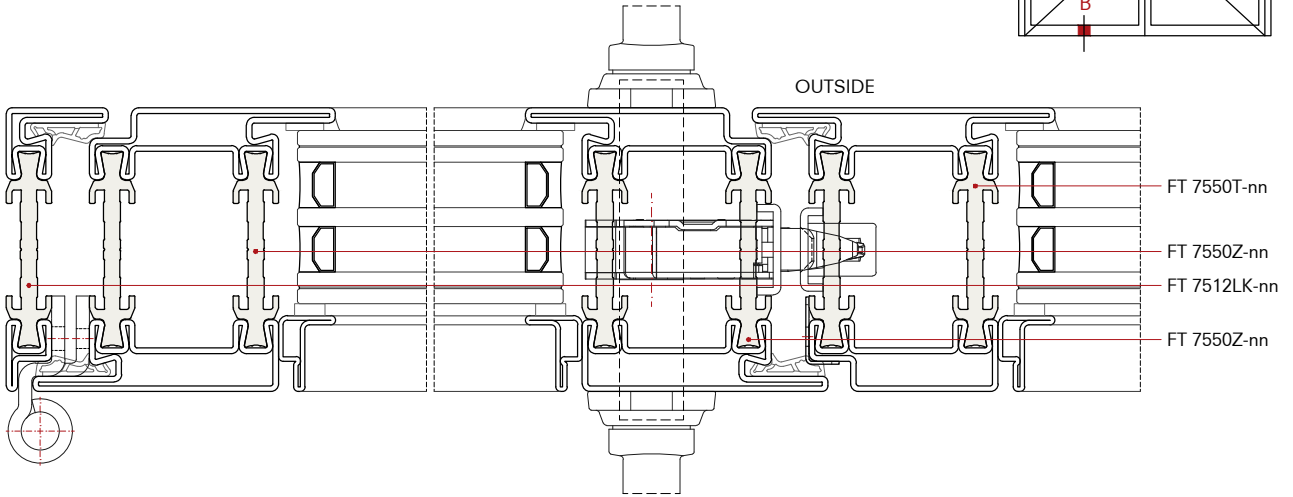

B

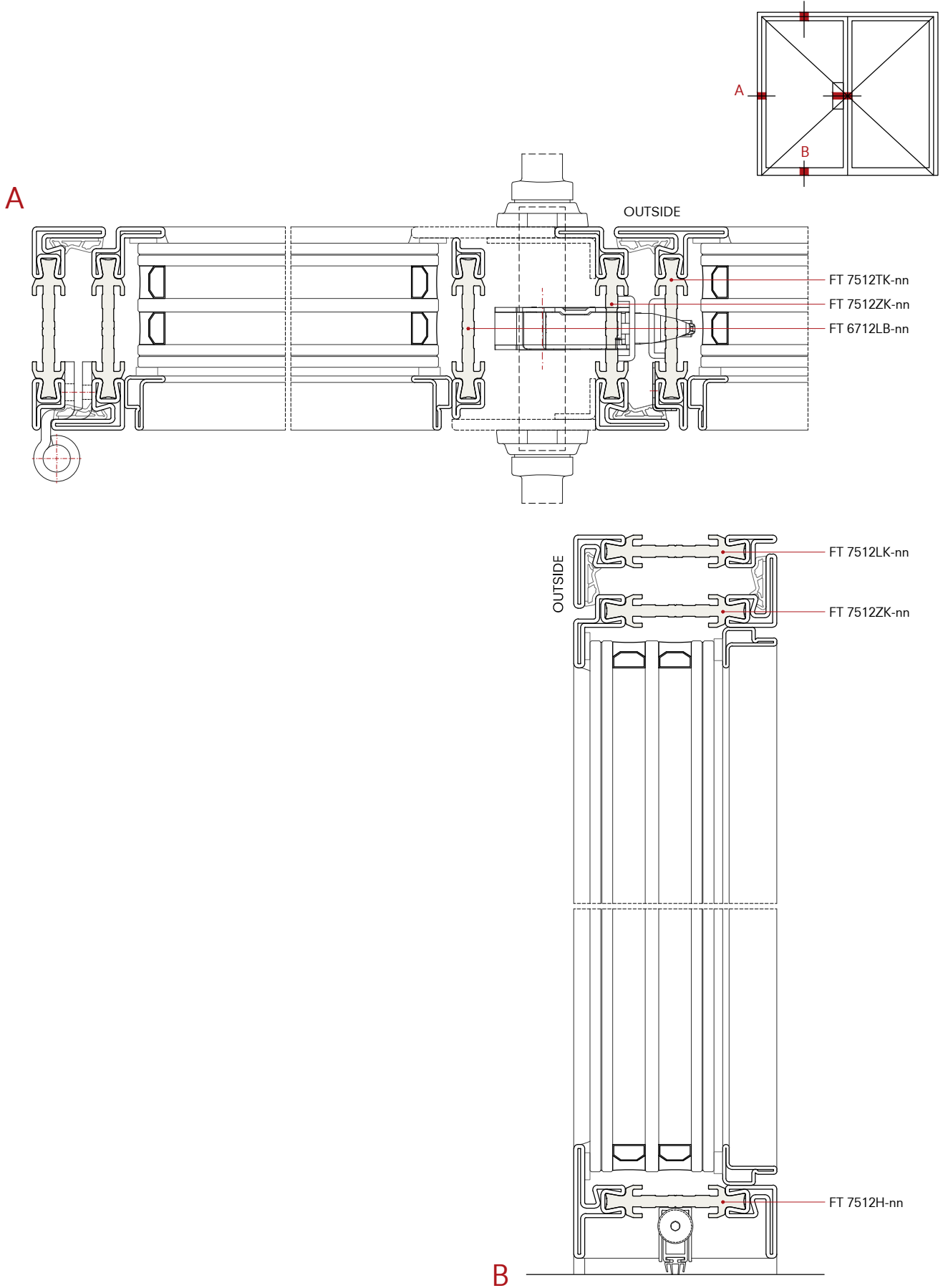

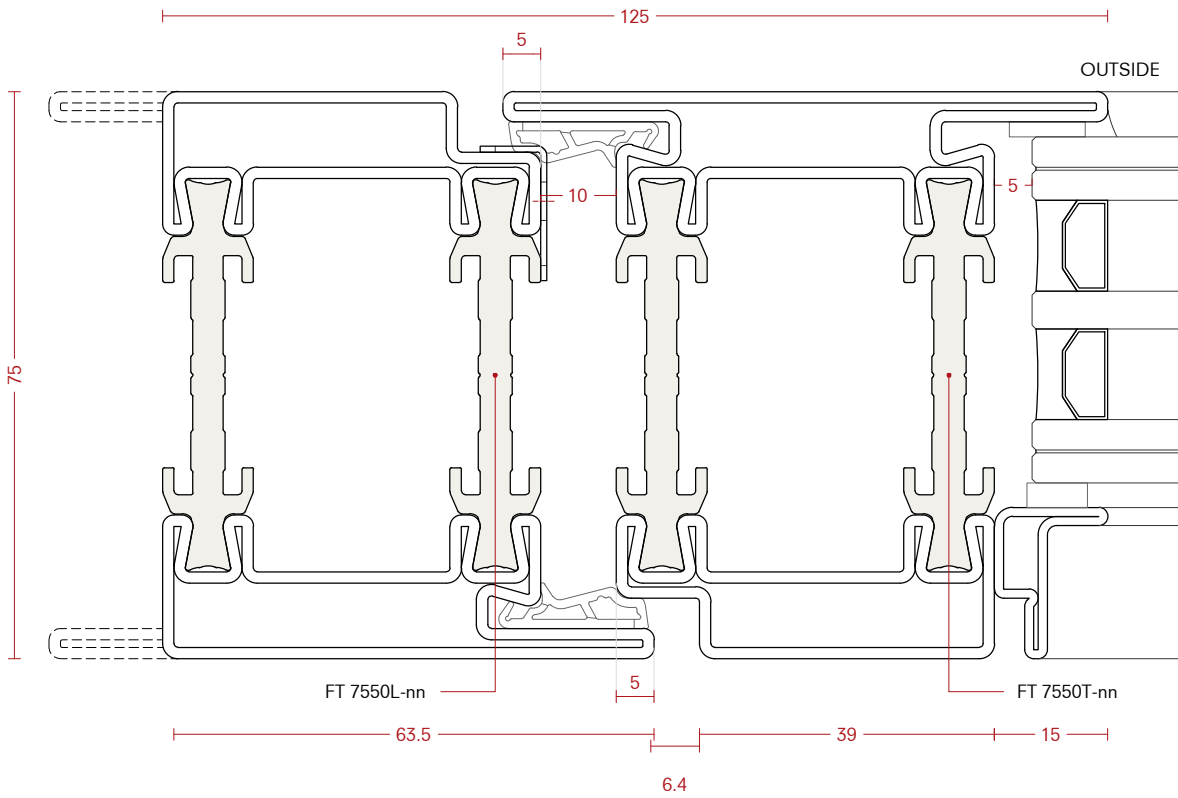
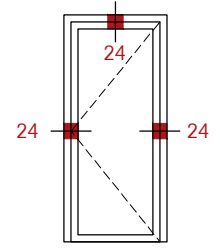

Detail 24

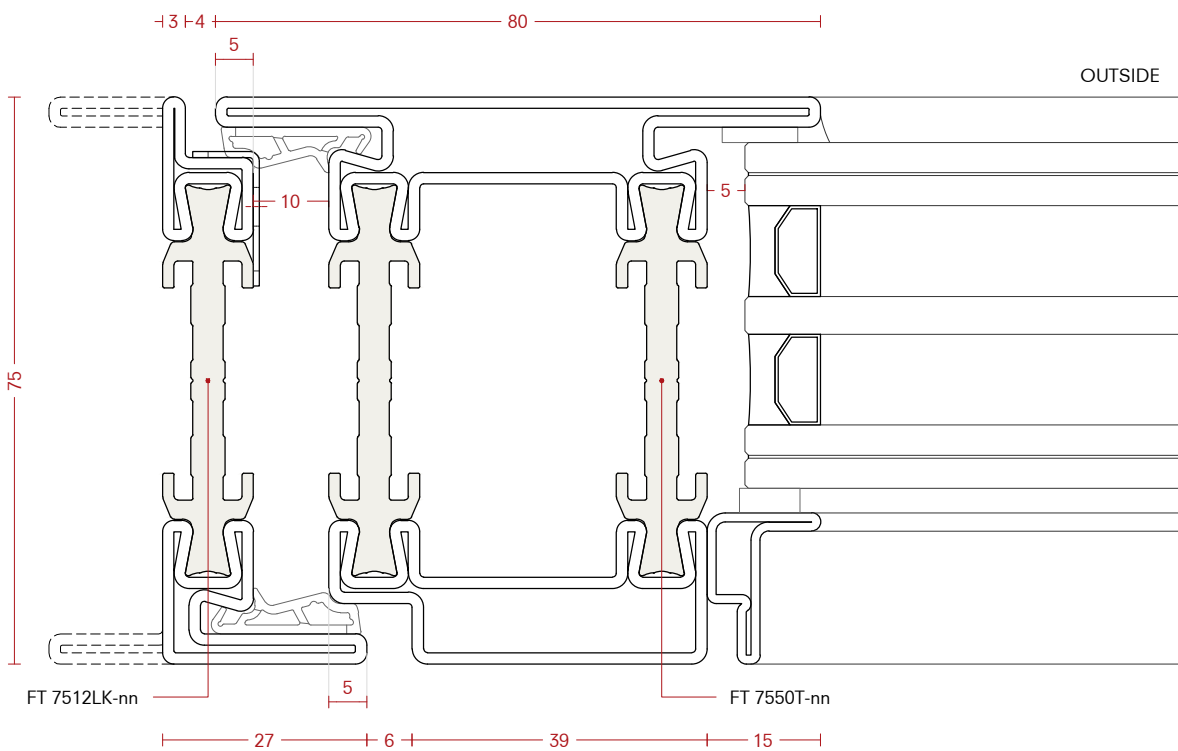

Detail 24

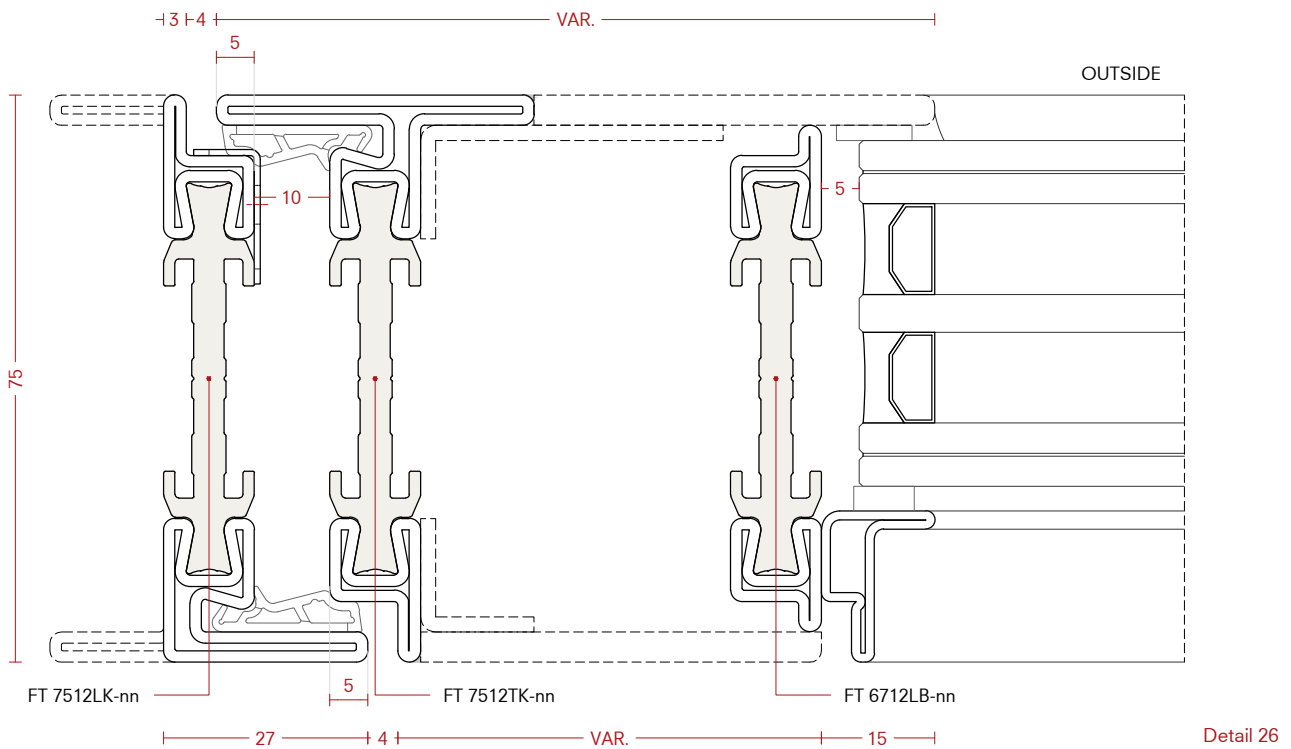
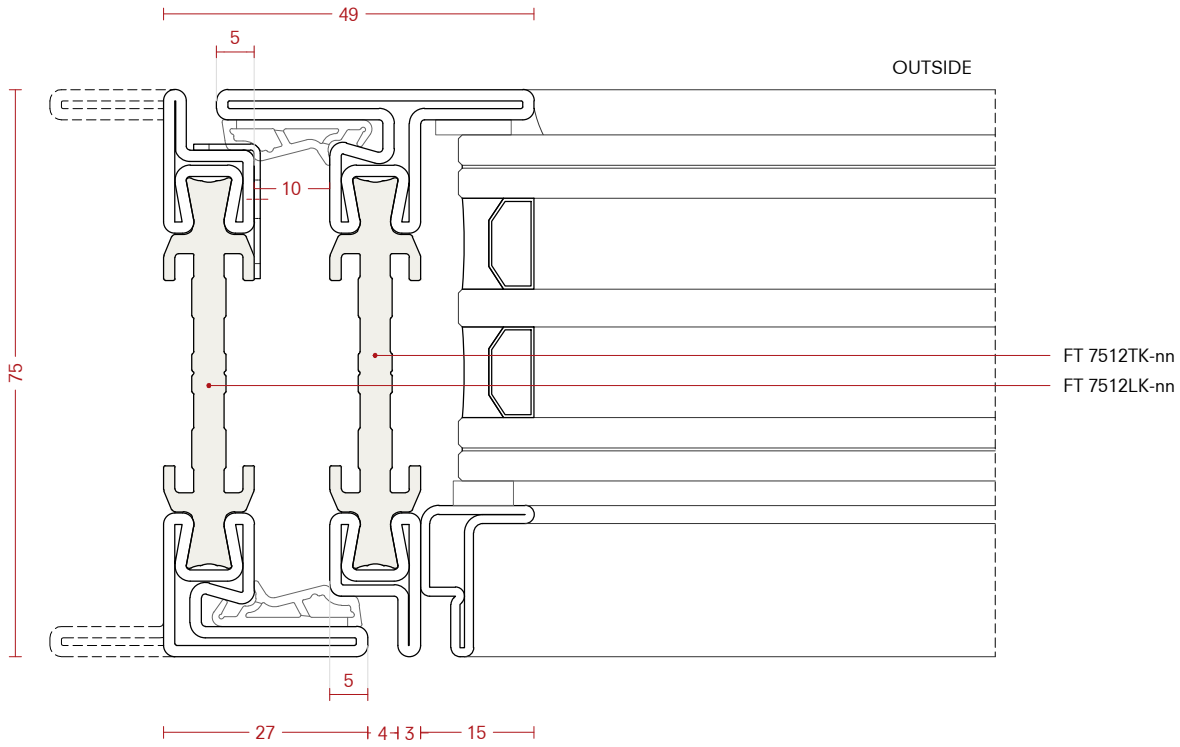
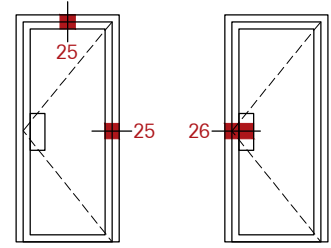

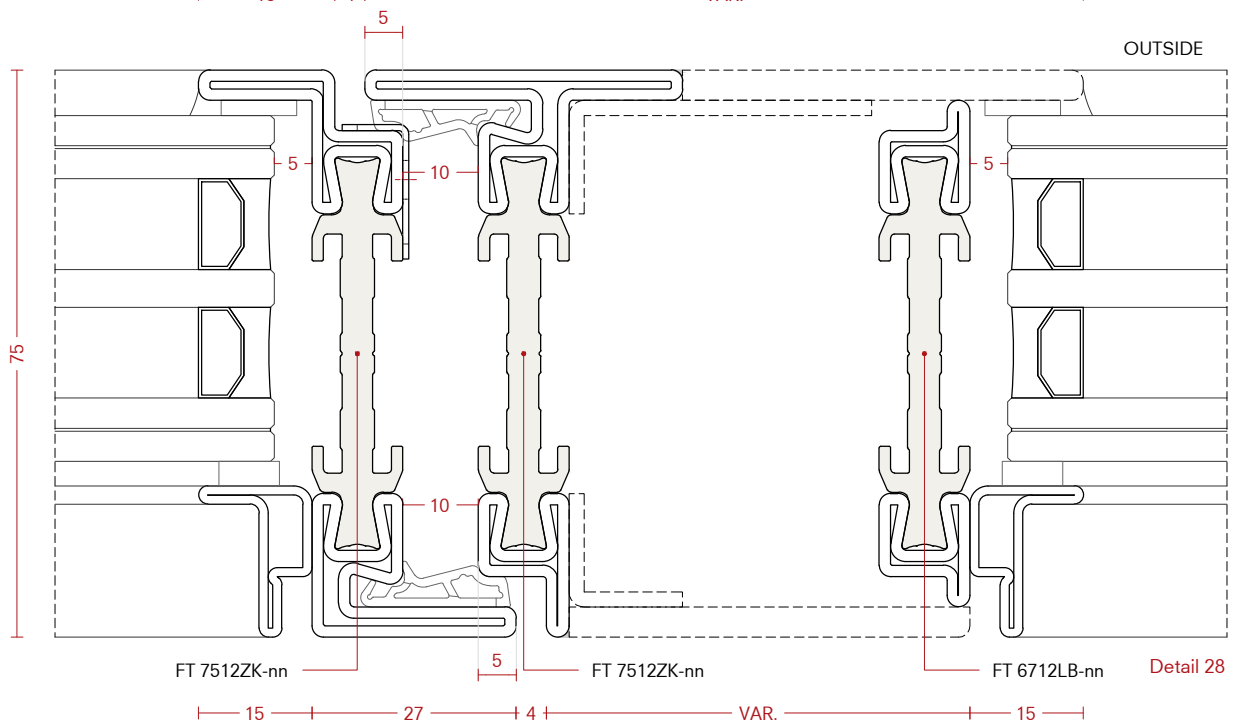
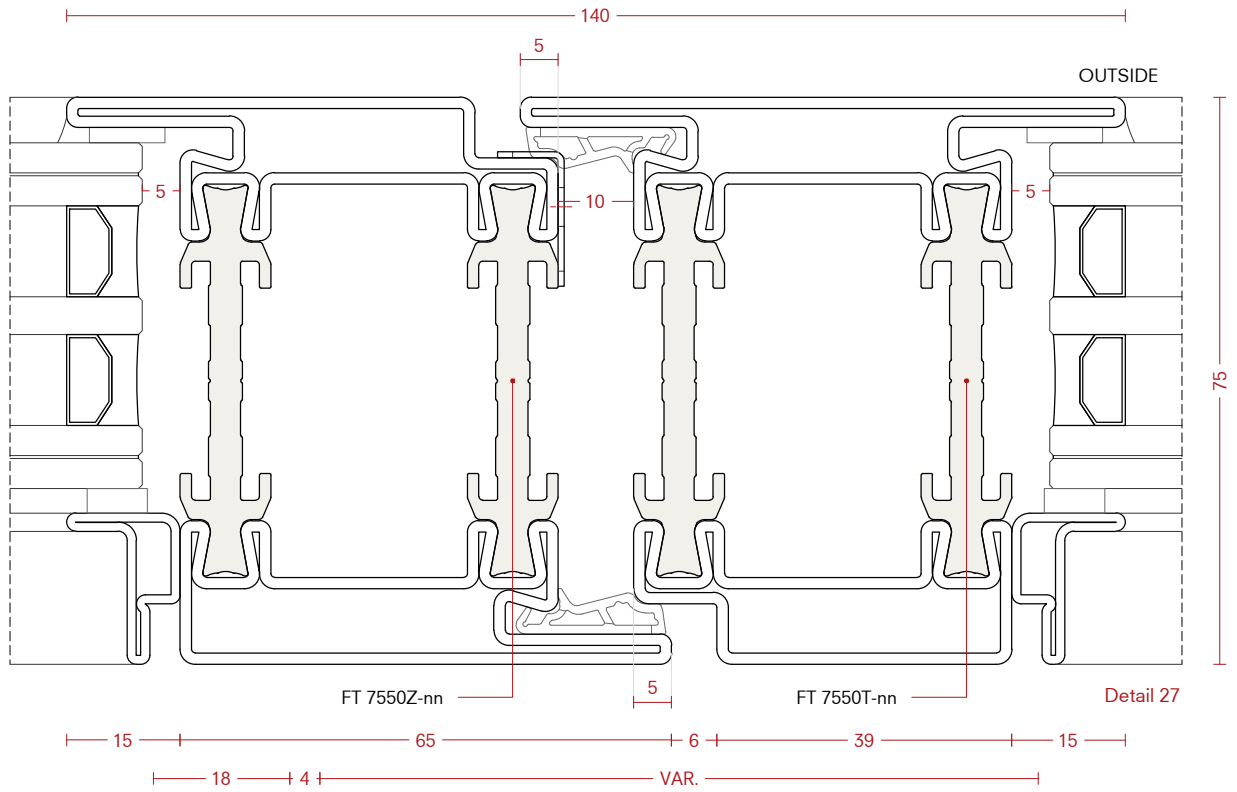
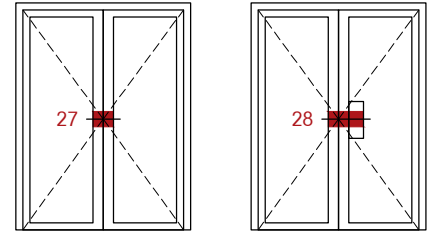

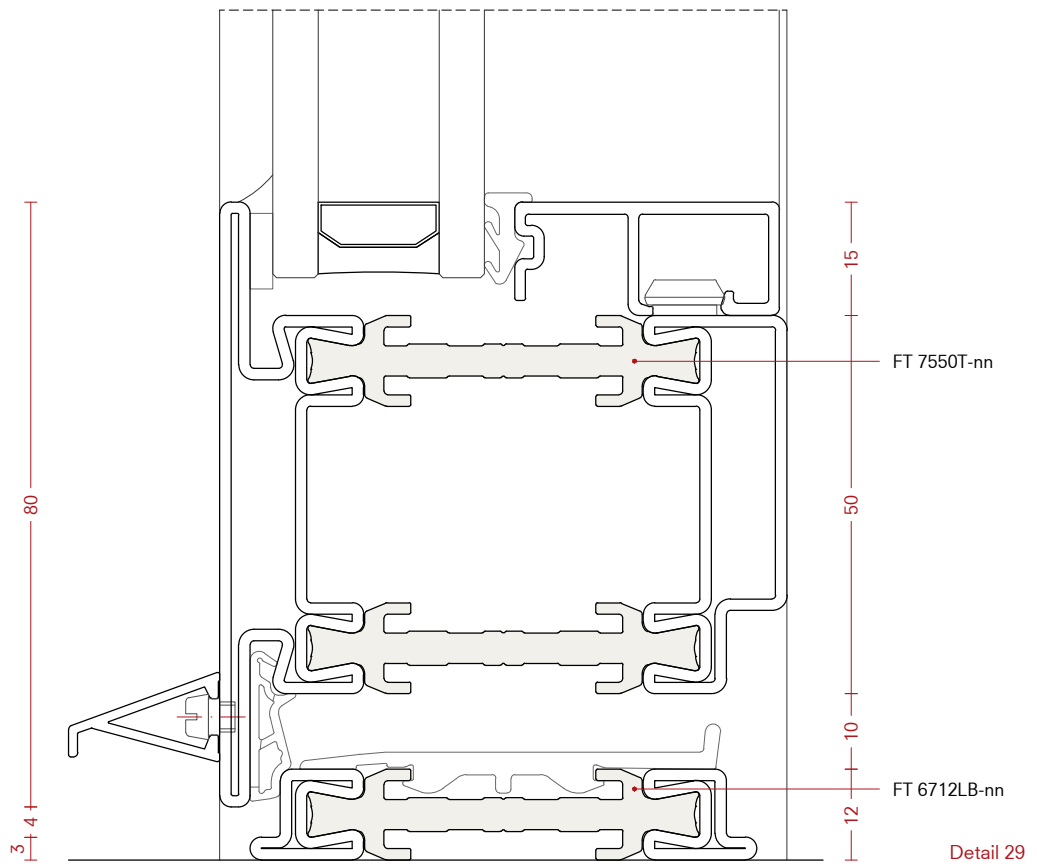
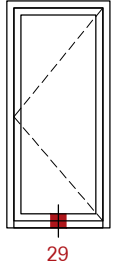

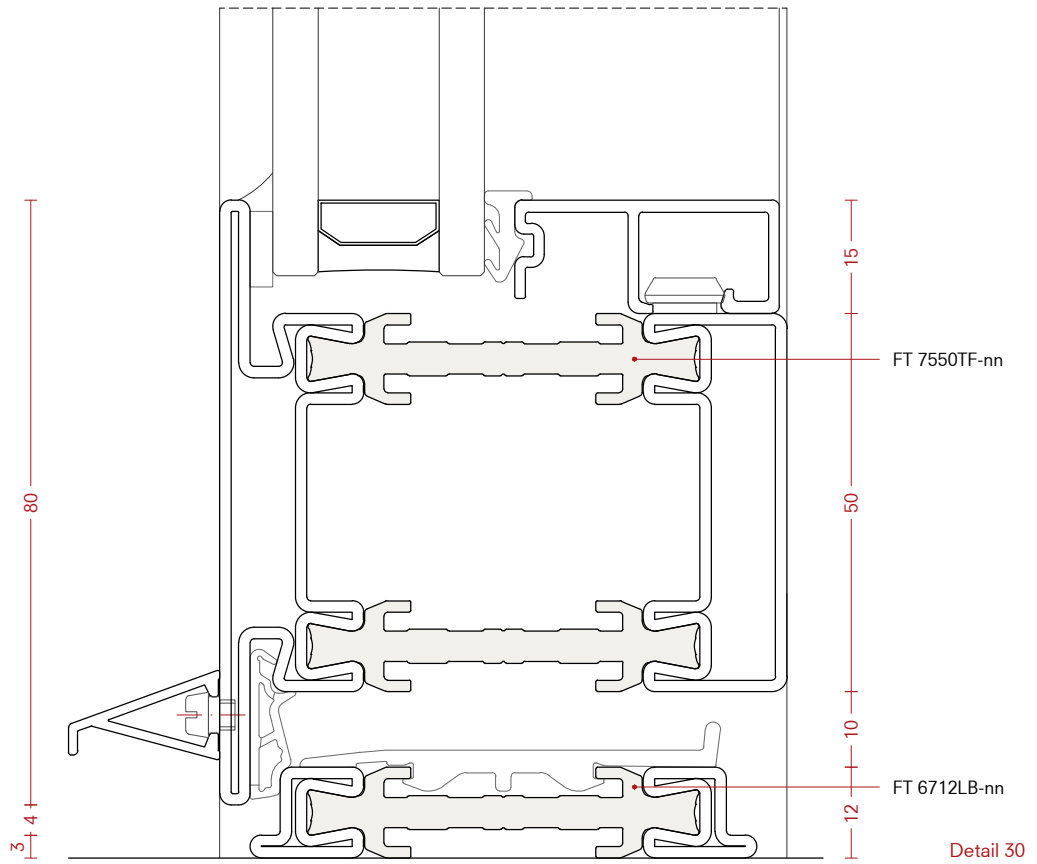
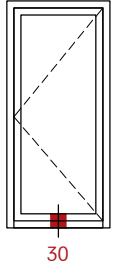

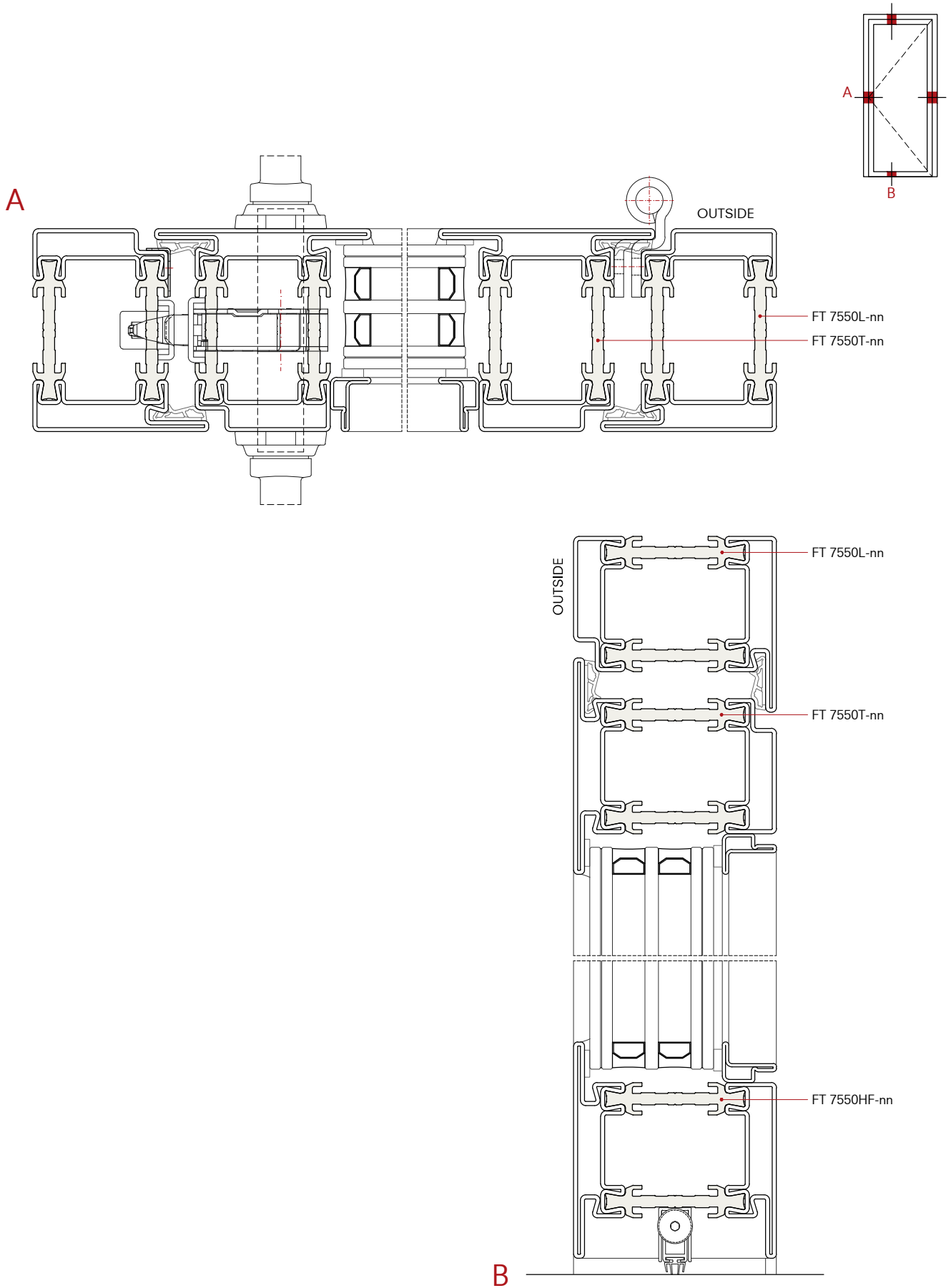

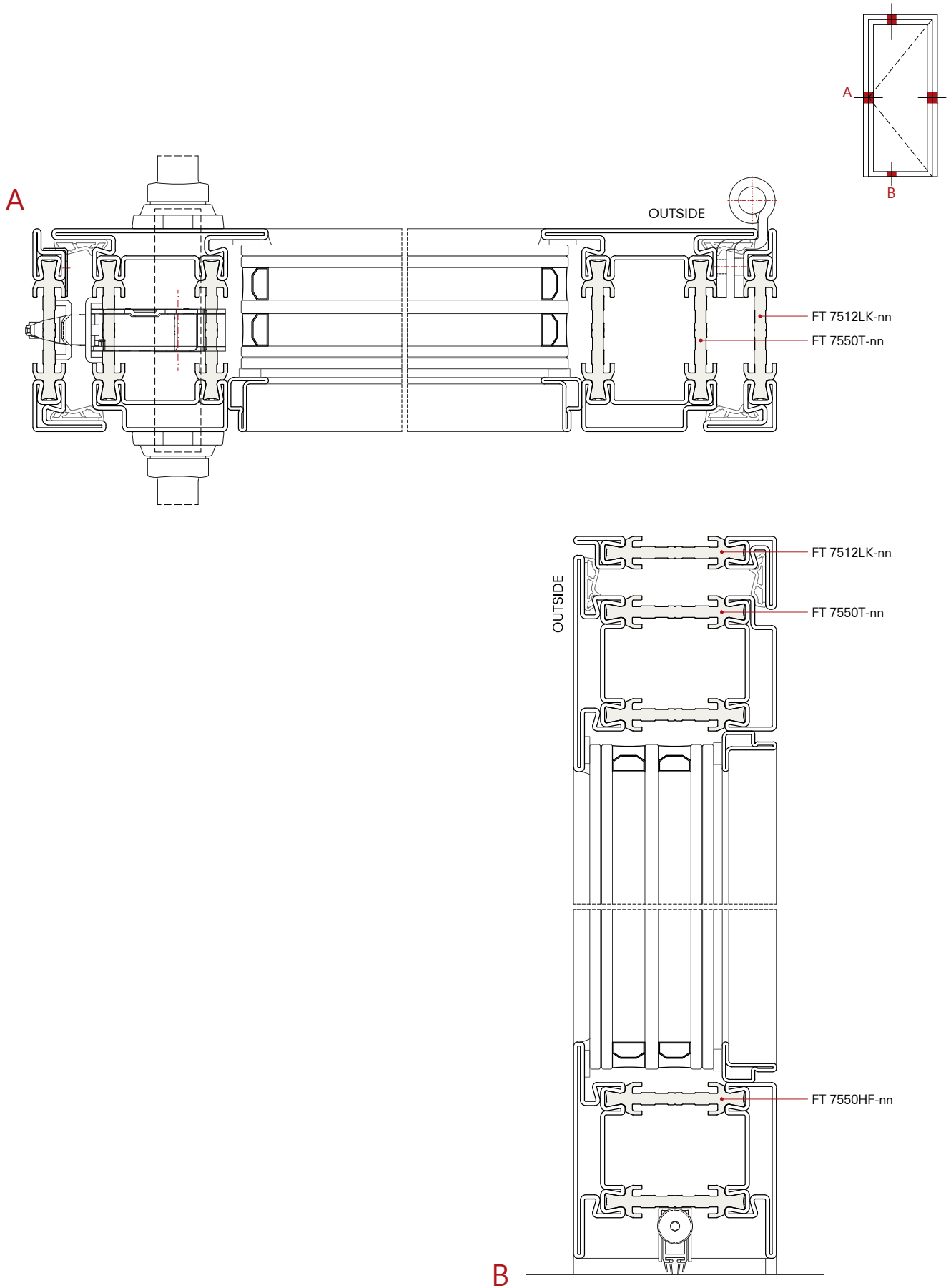

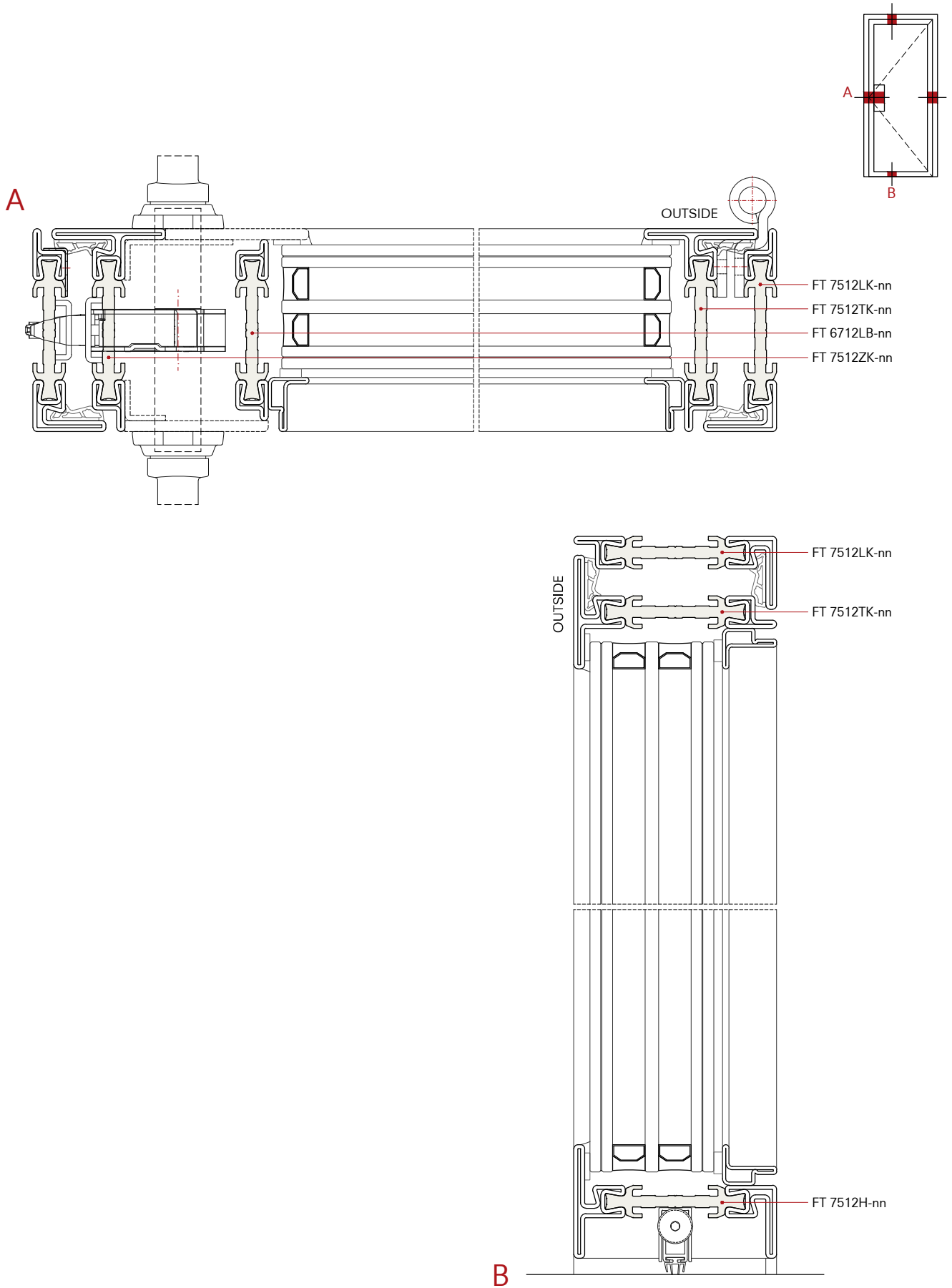

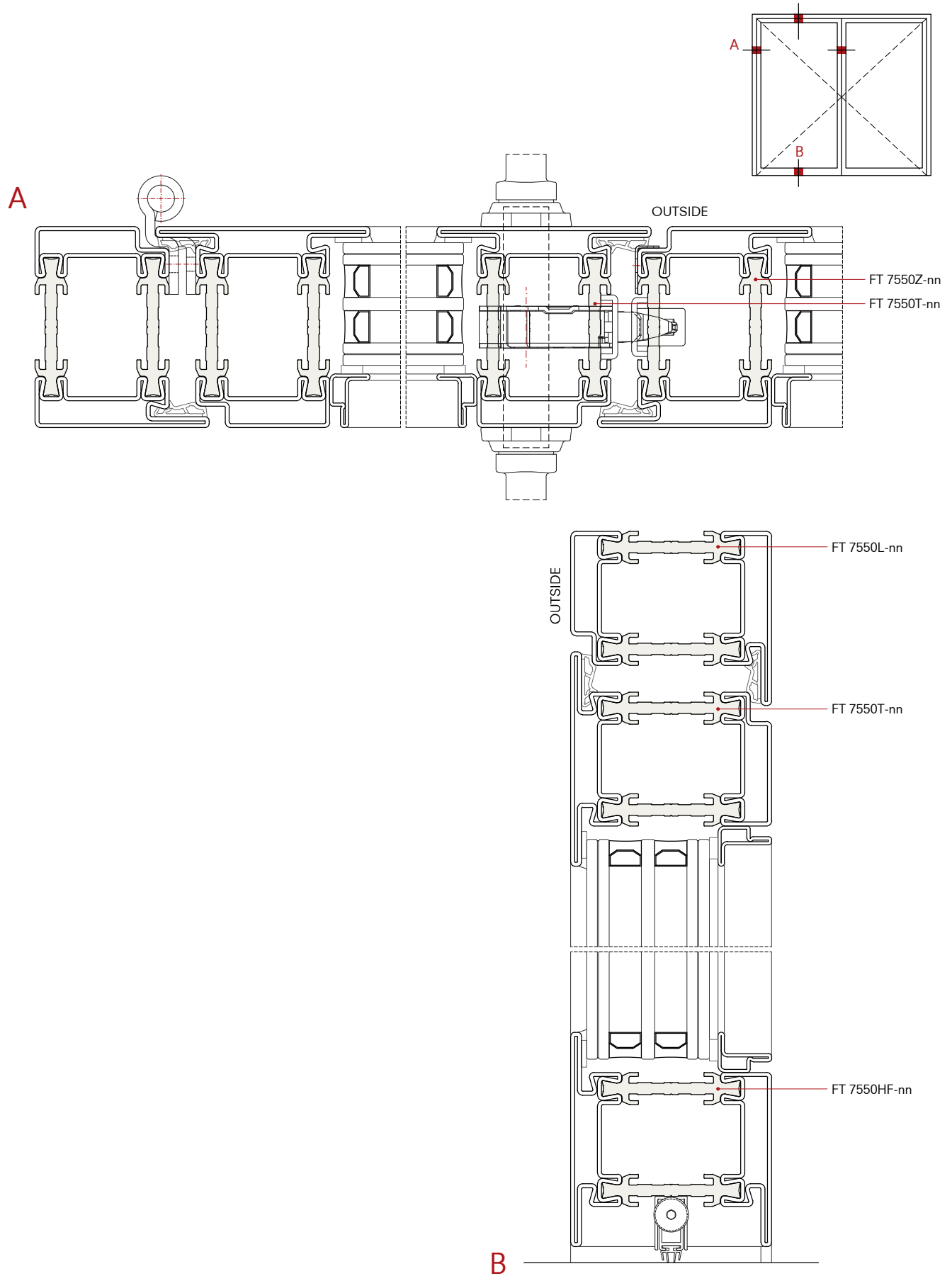

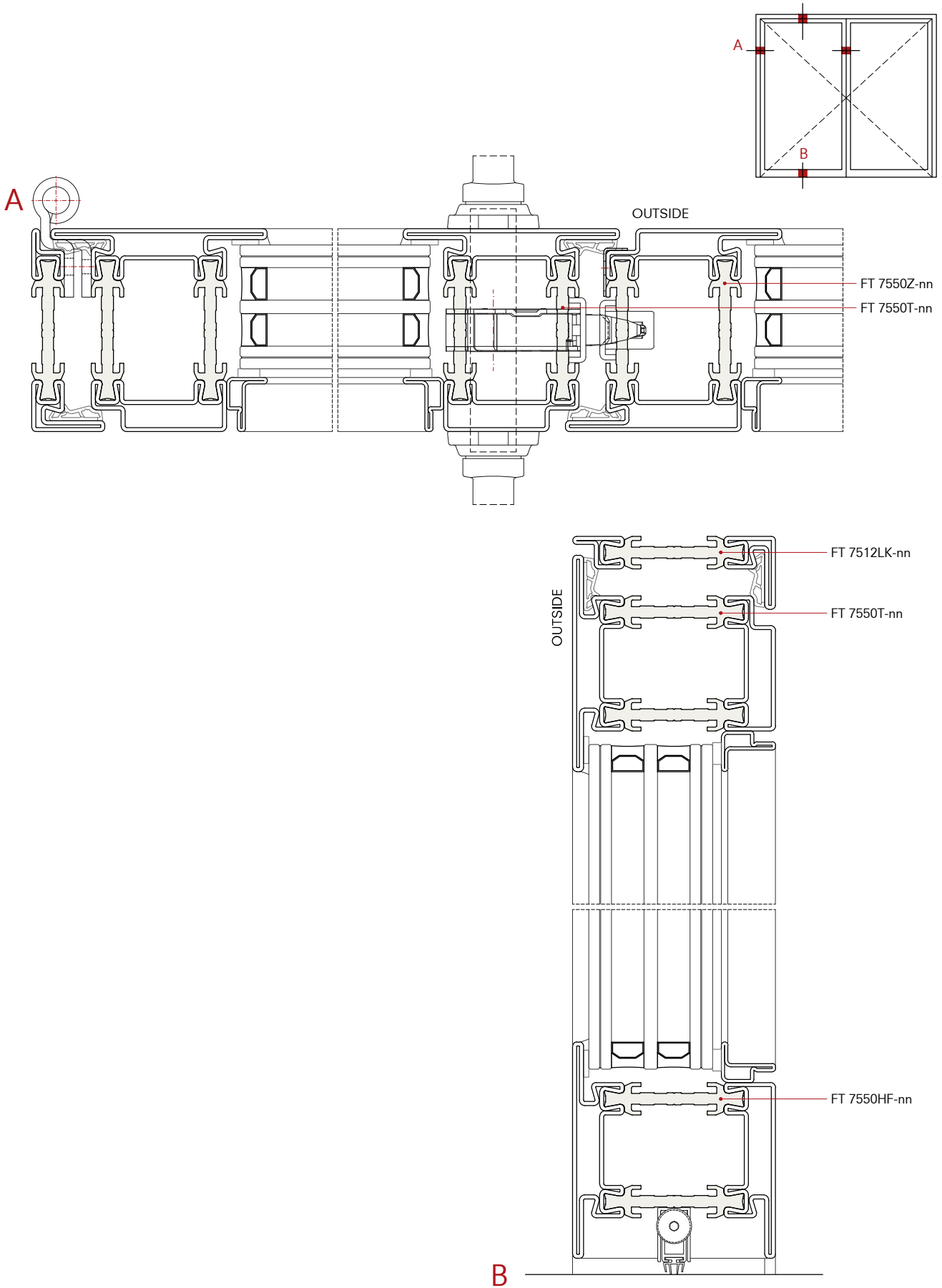

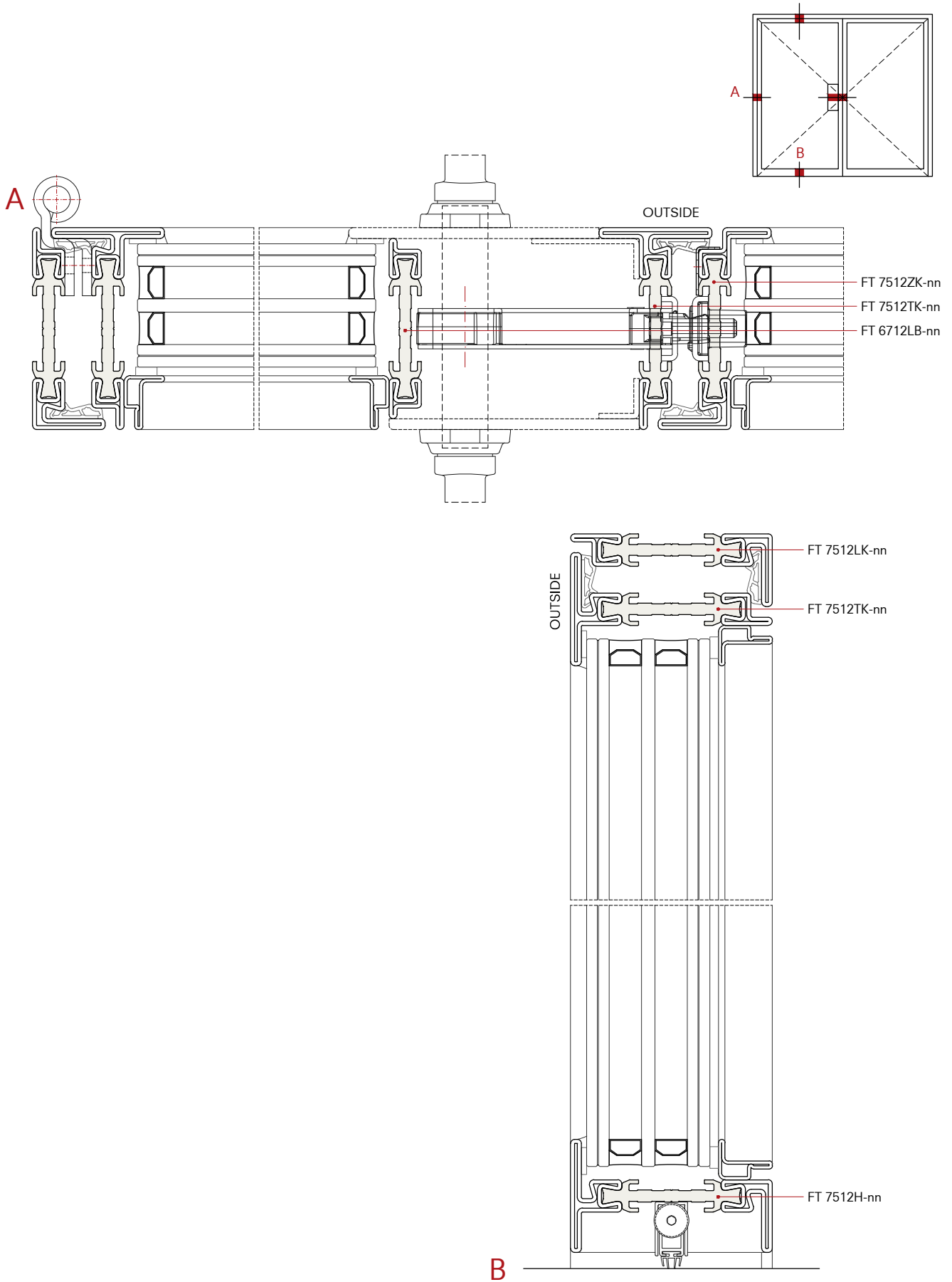

**Details, structural
connections**

**Dettagli di costruzione
giunti d'angolo**

Detalles de construcción

4.3

Legend

+ = Fixed
— = Open in
- - - = Open out
Dimensions in: mm
Scale 1:1

Legenda

+ = Anta fissa
— = Apertura interna
- - - = Apertura esterna
Misure in: mm
Scala 1:1

Leyenda

+ = Fijo
— = Apertura interna
- - - = Apertura externa
Medidas en: mm
Escala 1:1

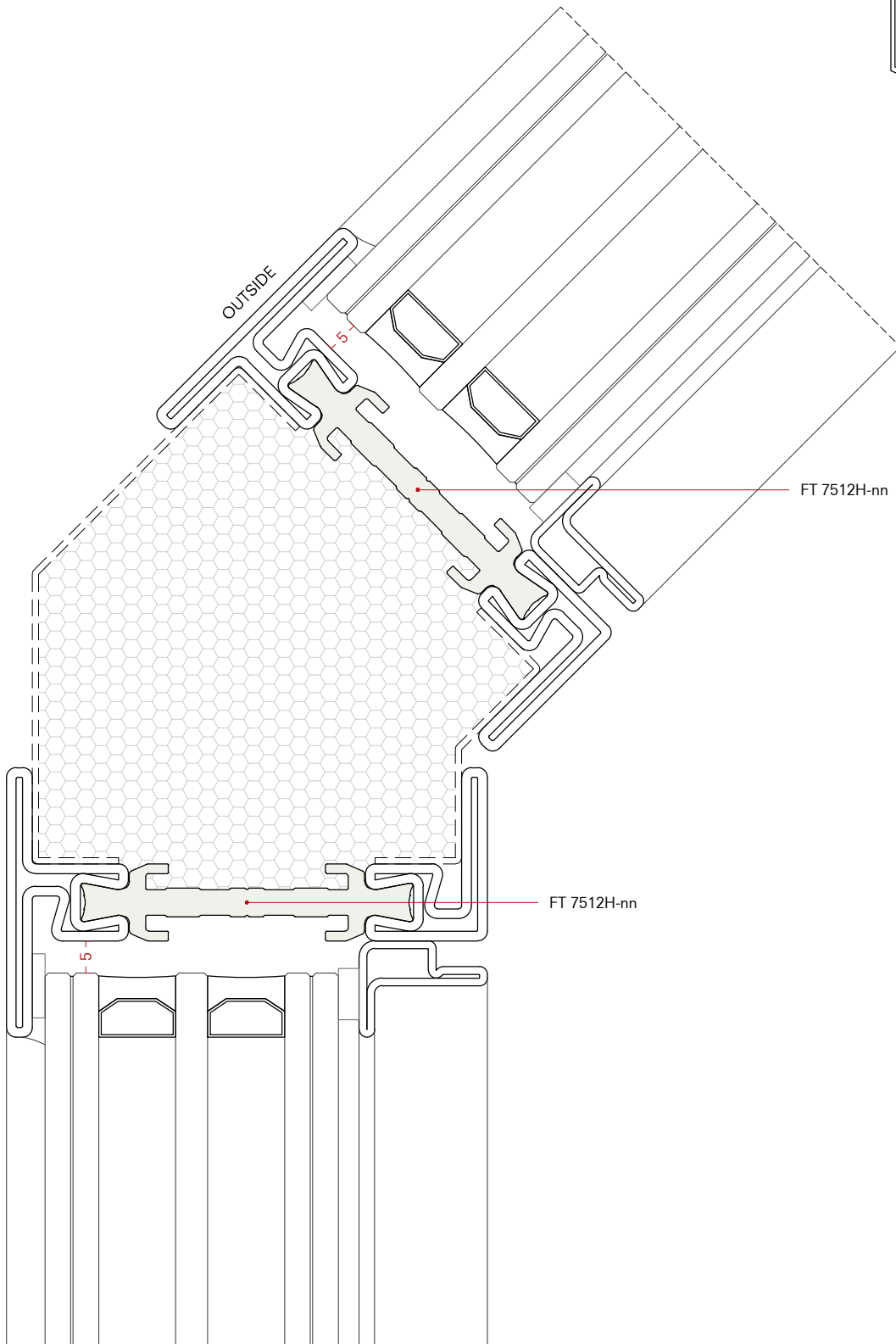
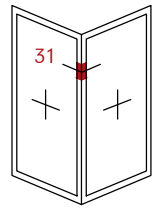

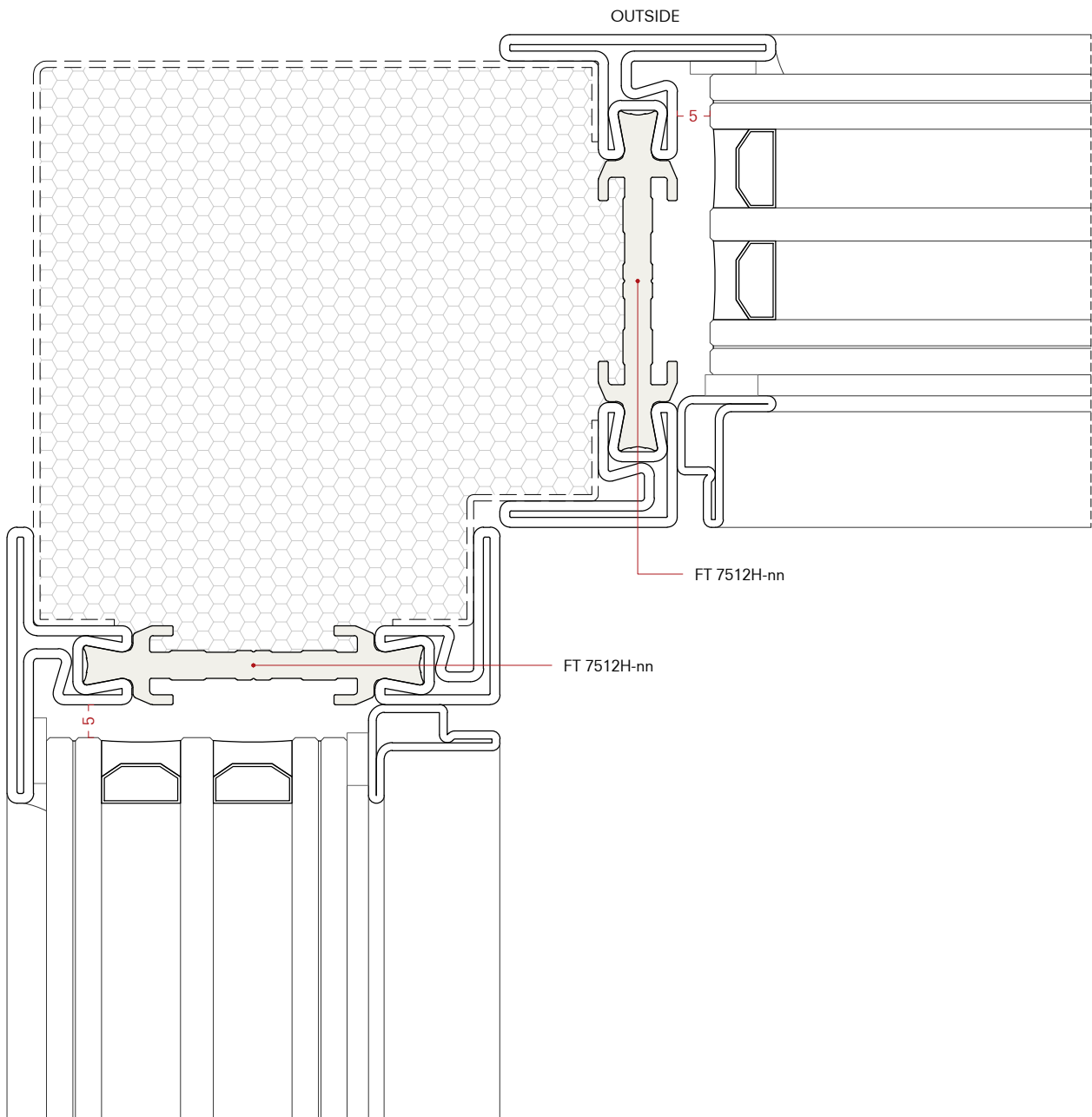
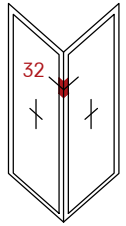

Wall connections

Attacchi a muro

Cierres constructivos

4.4

Legend

+ = Fixed
— = Open in
- - - = Open out
Dimensions in: mm
Scale 1:2

Legenda

+ = Anta fissa
— = Apertura interna
- - - = Apertura esterna
Misure in: mm
Scala 1:2

Leyenda

+ = Fijo
— = Apertura interna
- - - = Apertura externa
Medidas en: mm
Escala 1:2

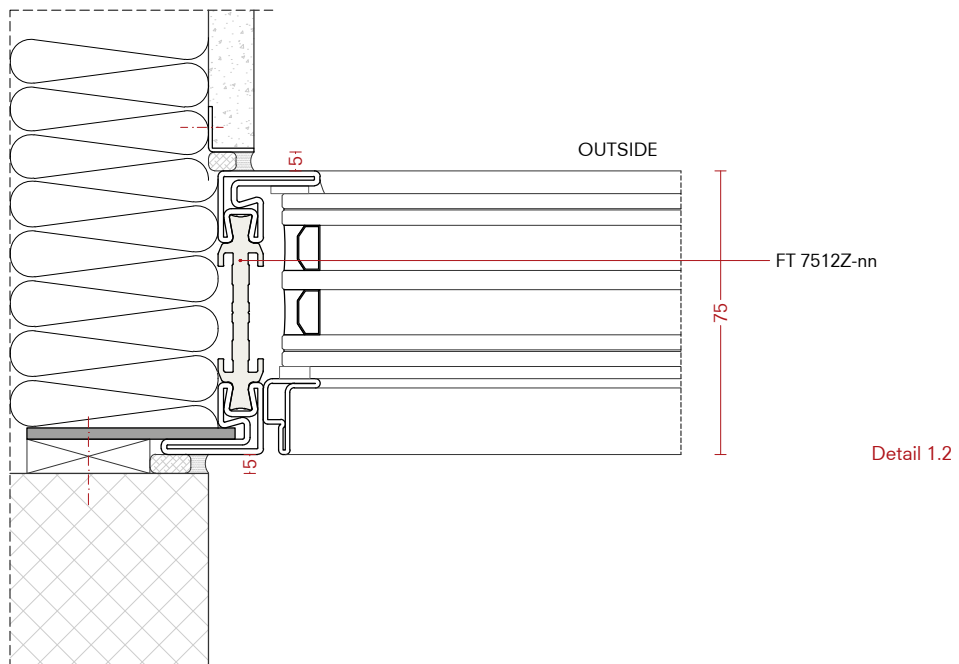
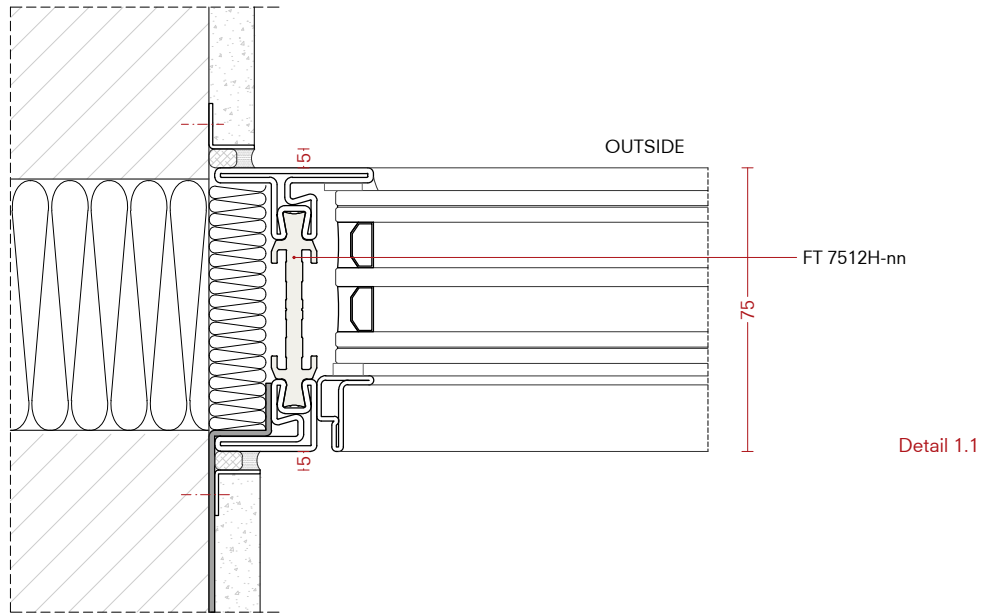

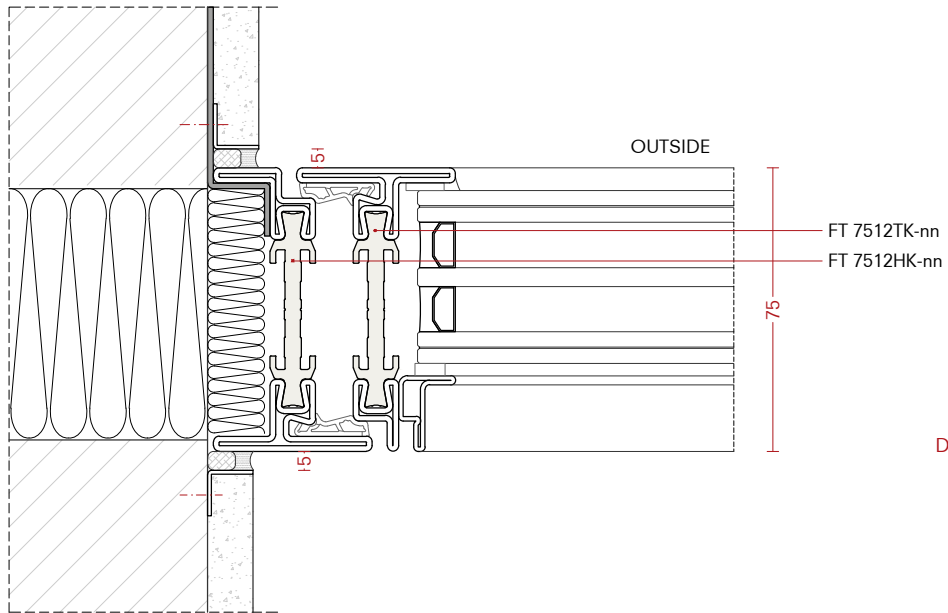

Detail 2.1

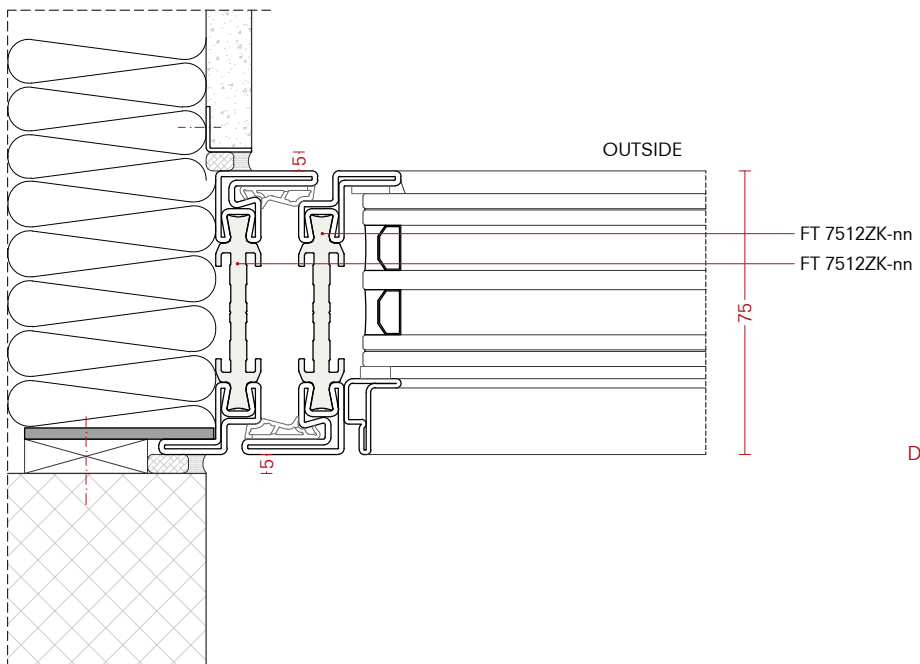

Detail 2.2

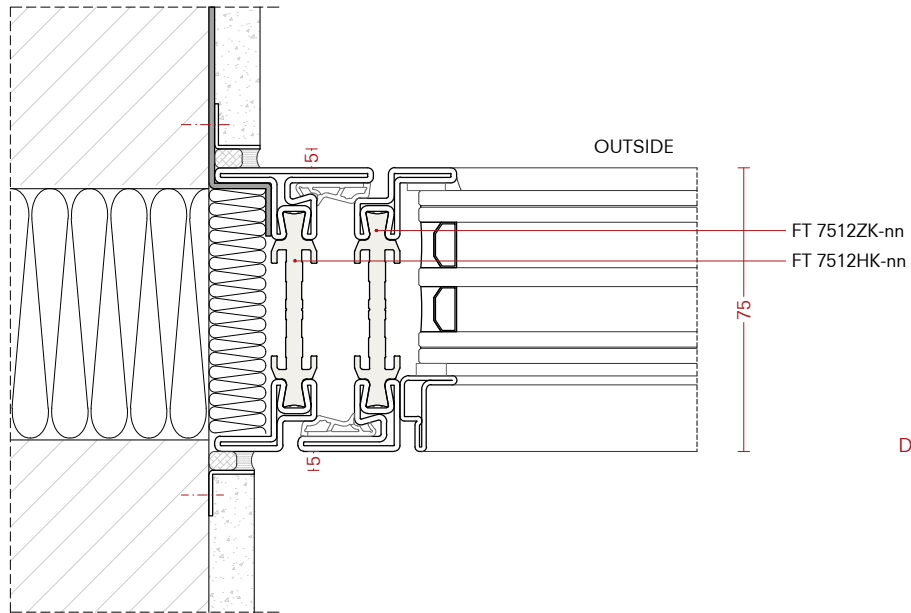

Detail 3.1

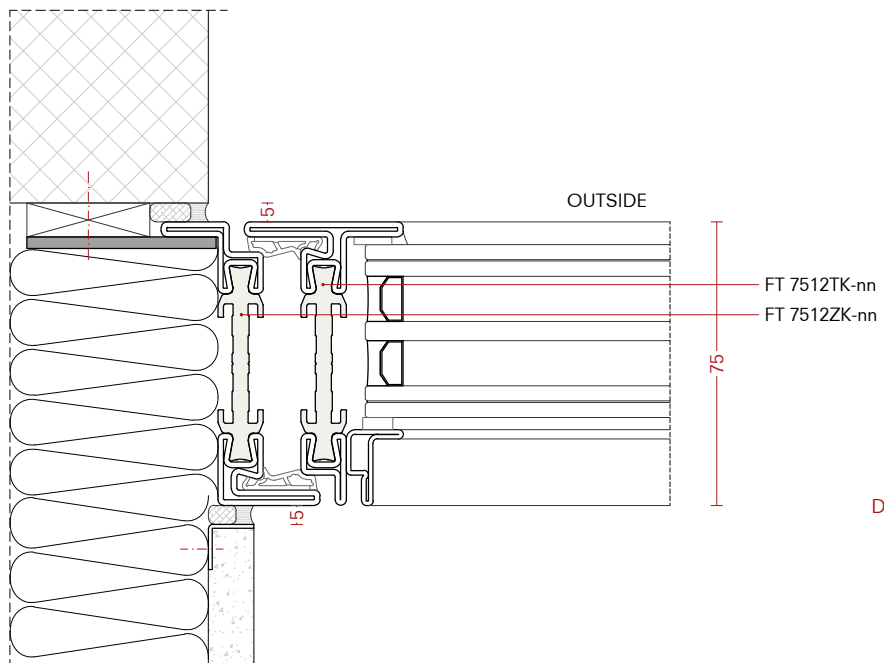

Detail 3.2

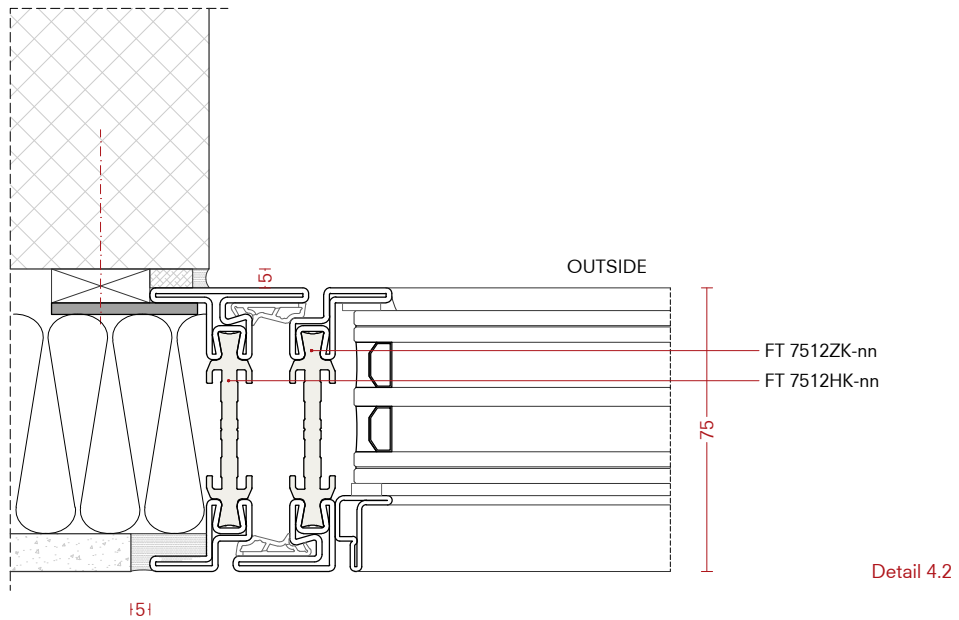
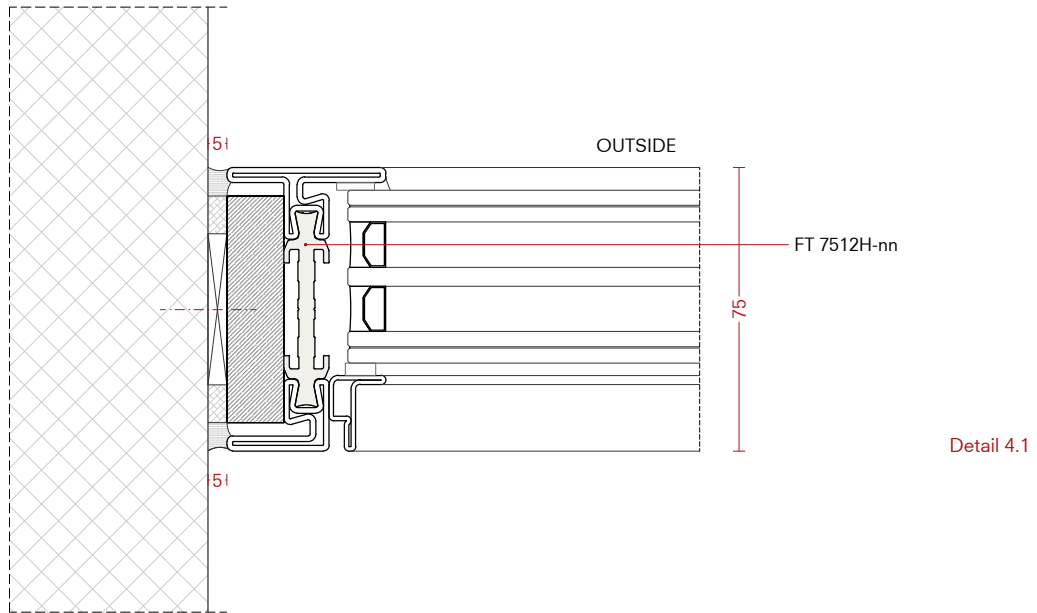

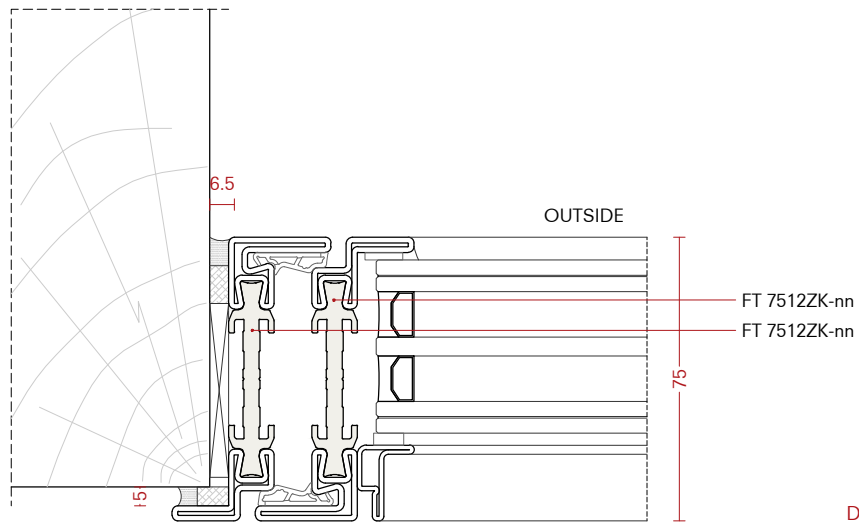
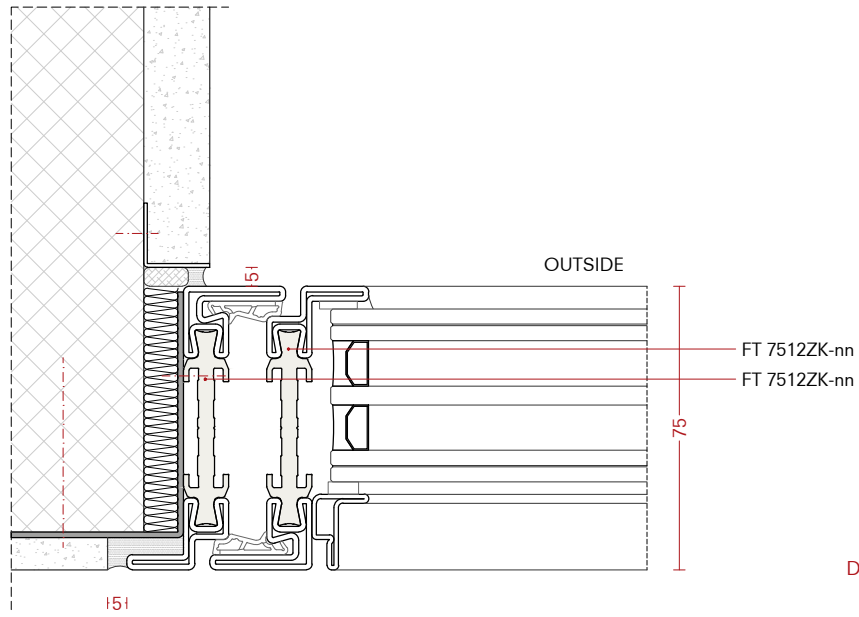

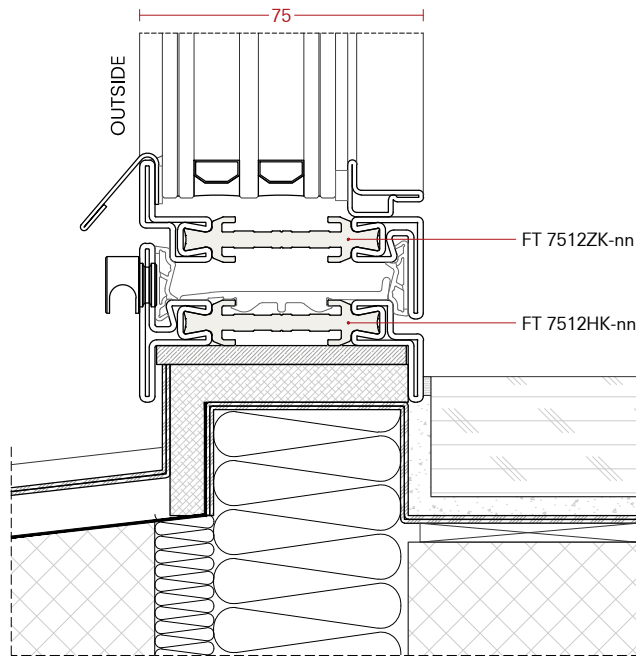

Detail 6.1

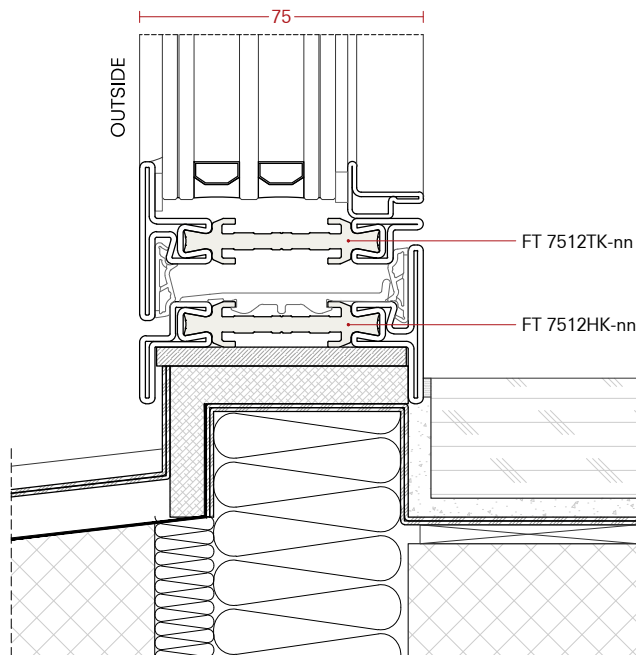

Detail 6.2

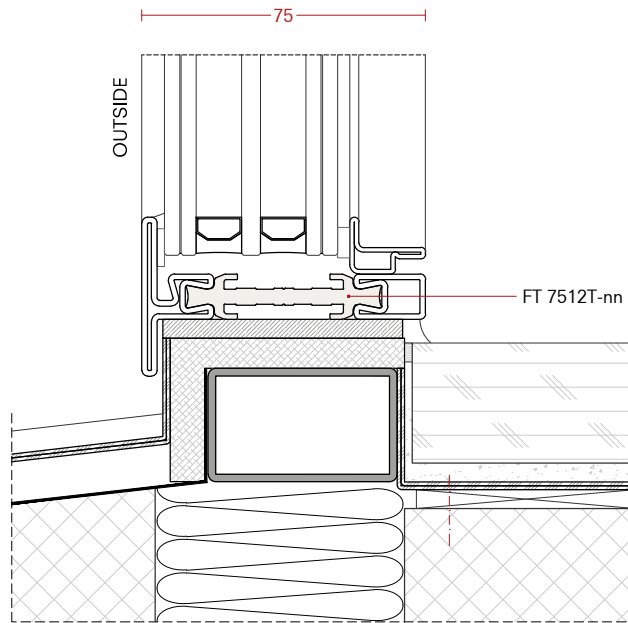

Detail 7.1

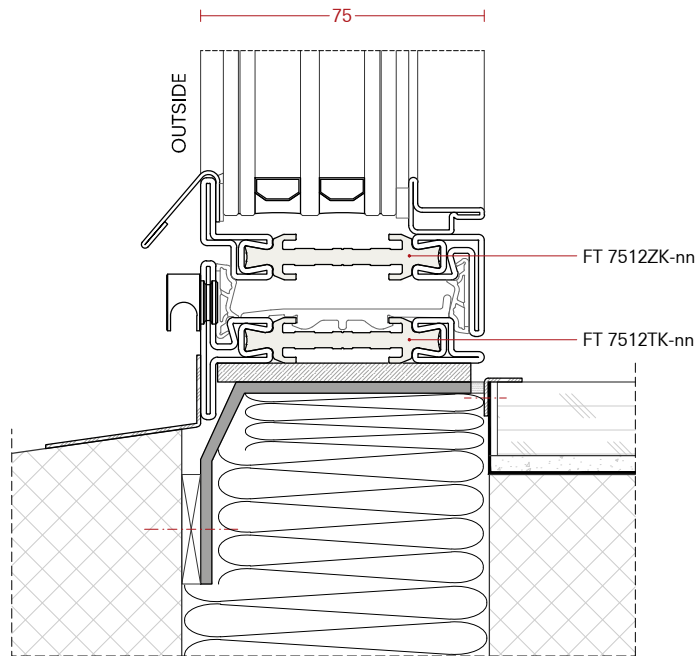

Detail 7.2

METALFORM

MASTERS OF METAL

UNITED KINGDOM

METALFORM

NORWAYMETAL LTD

53 Chelsea Manor Street

London, SW3 5RZ

SALES@METALFORM.UK

+44 20 81298814

GERMANY

METALFORM GMBH

Carl-Zeiss-Ring 15A

85737 Ismaning

SALES@METALFORMGROUP.DE

+49 17663630406

NORWAY

METALFORM AS

Brochmannsveien 2

1950 Rømskog

SALG@METALFORM.NO

+47 401 62 446

METALFORMGROUP

SALES@METALFORMGROUP.COM