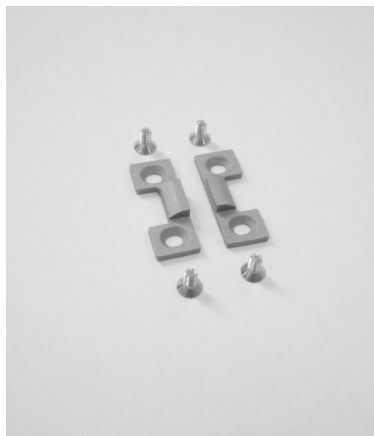

**AC 2624E.D**

Kit cremonese dx per finestre a due ante
Gratz con maniglia removibile
RH cremone bolt set for double leaf windows
Gratz mechanism with removable handle

AC 2624E.S

Kit cremonese sx per finestre a due ante
Gratz con maniglia removibile
LH cremone bolt set for double leaf windows
Gratz mechanism with removable handle

**AC 2627**

Chiusura mediana lato cerniere
Hinge-side middle closing

**AC 2625.D**

Kit cremonese dx per finestre ad un'anta | PR2943
RH cremone bolt set for single leaf windows | PR2943

AC 2625.S

Kit cremonese sx per finestre ad un'anta | PR2943
LH cremone bolt set for single leaf windows | PR2943

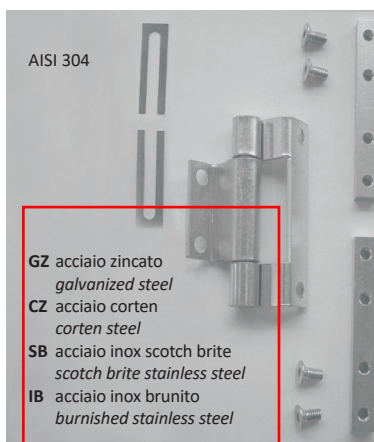

AISI 304

AC 2628.xx

Cerniera a tre ali da avvitare PR2933
Peso max anta 100 kg
Three-wing screw-on hinge PR2933
Max leaf weight 100 kg

GZ acciaio zincato galvanizzato steel
CZ acciaio corten corten steel
SB acciaio inox scotch brite scotch brite stainless steel
IB acciaio inox brunito burnished stainless steel

**AC 2625E.D**

Kit cremonese dx per finestre ad un'anta | PR2943
Gratz con maniglia removibile
RH cremone bolt set for single leaf windows | PR2943
Gratz mechanism with removable handle

AC 2625E.S

Kit cremonese sx per finestre ad un'anta | PR2943
Gratz con maniglia removibile
LH cremone bolt set for single leaf windows | PR2943
Gratz mechanism with removable handle



AISI 304

AC 2629.xx.D

Cerniera dx a due ali da avvitare PR2933
Peso max anta 50 kg
RH two-wing screw-on hinge PR2933
Max leaf weight 50 kg

IZ acciaio inox verniciabile | paintable stainless steel
CZ acciaio corten grezzo | untreated corten steel
SB acciaio inox scotch brite | scotch brite stainless steel
IB acciaio inox brunito | burnished stainless steel

**AC 2626R**

Punto di chiusura aggiuntivo per finestra

Additional locking point for windows



AISI 304

AC 2629.xx.S

Cerniera sx a due ali da avvitare PR2933
Peso max anta 50 kg
LH two-wing screw-on hinge PR2933
Max leaf weight 50 kg

IZ acciaio inox verniciabile | paintable stainless steel
CZ acciaio corten grezzo | untreated corten steel
SB acciaio inox scotch brite | scotch brite stainless steel
IB acciaio inox brunito | burnished stainless steel

**AC 2631.A**

Cerniera a due ali in acciaio zincato a saldare | Ø 10
Peso max anta 40 kg

*Weld-on hinge in galvanised steel | Ø 10
Max leaf weight 40 kg*

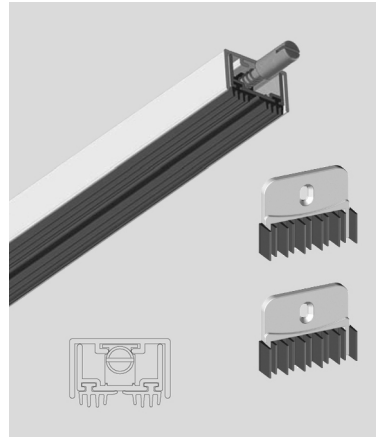
**AC 2636.x**

Guarnizione automatica di tenuta sotto porta

Automatic bottom seal

AC2636.Z lunghezza/length 315 - 430 mm
AC2636.A lunghezza/length 380 - 530 mm
AC2636.B lunghezza/length 480 - 630 mm
AC2636.C lunghezza/length 580 - 730 mm
AC2636.D lunghezza/length 680 - 830 mm
AC2636.E lunghezza/length 780 - 930 mm
AC2636.F lunghezza/length 880 - 1030 mm
AC2636.G lunghezza/length 980 - 1130 mm
AC2636.H lunghezza/length 1080 - 1230 mm

**AC 2631.B**

Cerniera a due ali in acciaio zincato a saldare | Ø 13
Peso max anta 70 kg

*Weld-on hinge in galvanised steel | Ø 13
Max leaf weight 70 kg*

**AC 2639.xx**

Kit cerniere a scomparsa per vasistas "ochette"
Solo per profilo PR2933

*Concealed hinges for bottom-hung windows
Only for PR2933 profile*

AISI 304
IZ acciaio inox verniciabile | paintable stainless steel
CZ acciaio corten grezzo | untreated corten steel
ST acciaio inox scotch brite | scotch brite stainless steel
IB acciaio inox brunito | burnished stainless steel

**AC 2632.B**

Cerniera registrabile a due ali in acciaio zincato a saldare | Ø 13
Peso max anta 70 kg

*Adjustable weld-on hinge in galvanised steel | Ø 13
Max leaf weight 70 kg*

**AC 2640.xx**

Cricchetto per vasistas

Finger catch for bottom-hung windows

BR ottone grezzo verniciabile
paintable untreated brass
BB ottone brunito
burnished brass

**AC 2632.C**

Cerniera registrabile a due ali in acciaio zincato a saldare | Ø 16
Peso max anta 80 kg

*Adjustable weld-on hinge in galvanised steel | Ø 16
Max leaf weight 80 kg*

**AC 2641**

Braccetti per vasistas
Peso max anta 40 Kg

*Stays for bottom-hung windows
Max leaf weight 40 kg*

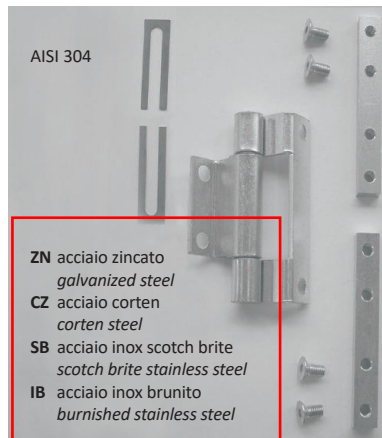
**AC 2648.xx**

Cerniera a tre ali da avvitare
 su PR2943 (apertura interna)
 su PR2962 (apertura esterna)
 Peso max anta 100 kg

*Three-wing screw-on hinge
 on PR2943 (inward opening)
 on PR2962 (outward opening)
 Max leaf weight 100 kg*

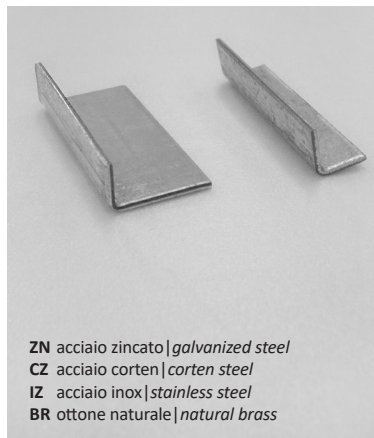
**AC 2652.xx**

Kit fondini per profili
 PR2942 - PR2943

*Fittings kit for profiles
 PR2942 - PR2943*

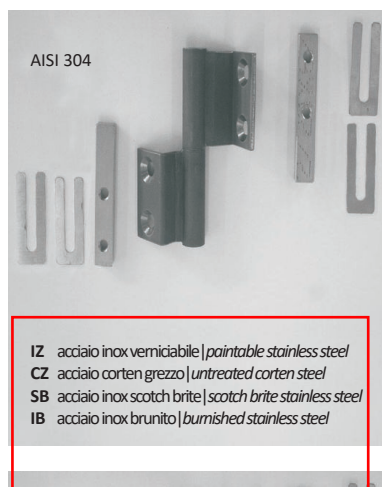
**AC 2649.xx.ISED**

Cerniera a due ali da avvitare
 Sx su PR2943 (apertura interna)
 Dx su PR2962 (apertura esterna)
 Peso max anta 50 kg

*Two-wing screw-on hinge
 LH on PR2943 (inward opening)
 RH on PR2962 (outward opening)
 Max leaf weight 50 kg*

Scelta verso cerniera pg. 5.3.1
 Side hinge choice pg. 5.3.1

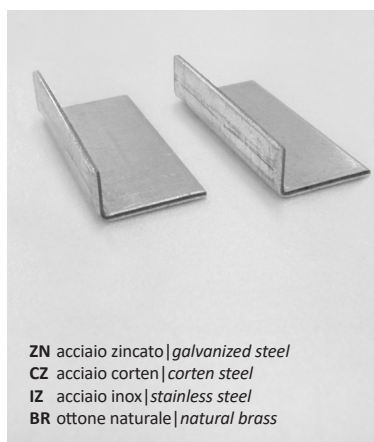
**AC 2653.xx**

Kit fondini per profili
 PR2962 - PR2963

*Fittings kit for profiles
 PR2962 - PR2963*

**AC 2649.xx.IDES**

Cerniera a due ali da avvitare
 Dx su PR2943 (apertura interna)
 Sx su PR2962 (apertura esterna)
 Peso max anta 50 kg

*Two-wing screw-on hinge
 RH on PR2943 (inward opening)
 LH on PR2962 (outward opening)
 Max leaf weight 50 kg*

Scelta verso cerniera pg. 5.3.1
 Side hinge choice pg. 5.3.1

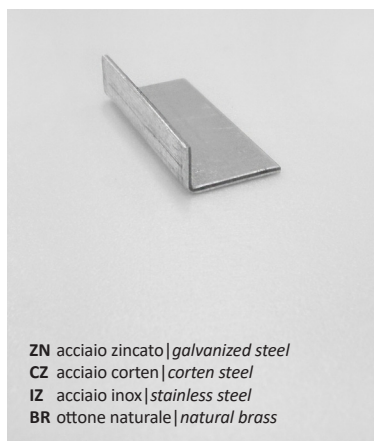
**AC 2654.xx**

Fondini per profili
 PR2942 - PR2905 (PR2955)

*Fittings for profiles
 PR2942 - PR2905 (PR2955)*

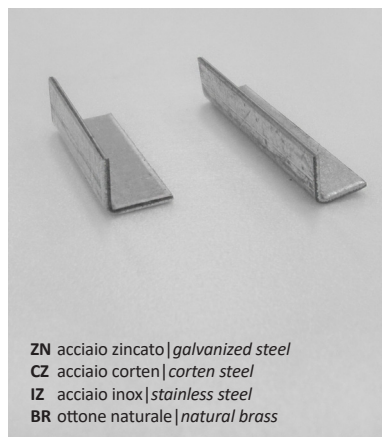
**AC 2651.xx**

Kit fondini per profili
 PR2932 - PR2933

*Fittings kit for profiles
 PR2932 - PR2933*

**AC 2658.xx**

Fondino per profili
 PR2975 | PR2991 | PR2992
 PR2993 | PR2995
 (apertura interna)

*Fittings for profiles
 PR2975 | PR2991 | PR2992
 PR2993 | PR2995
 (inward opening)*

**AC 2659.xx**

Fondino per profili
PR2975 | PR2991 | PR2992
PR2993 | PR2995
(apertura esterna)

Fittings for profiles
PR2975 | PR2991 | PR2992
PR2993 | PR2995
(outward opening)

GZ acciaio zincato | *galvanized steel*
CZ acciaio corten | *corten steel*
I acciaio inox | *stainless steel*
B ottone naturale | *natural brass*

**AC 2684.D**

Kit cremone dx per finestre
a due ante - apertura esterna

*RH cremone bolt set for double
leaf windows - outward opening*

AC 2684.S

Kit cremone sx per finestre
a due ante - apertura esterna

*LH cremone bolt set for double leaf
windows - outward opening*

**AC 2680.xx**

Maniglia di trascimento
per aperture esterne

*Pulling handle for outward
opening*

BR ottone grezzo verniciabile | *paintable untreated brass*
BB ottone brunito | *burnished brass*
CZ acciaio corten grezzo | *untreated corten steel*
SB acciaio inox scotch brite | *scotch-brite stainless steel*

**AC 2684E.D**

Kit cremone dx per finestre
a due ante - apertura esterna
Gratz con maniglia removibile
*RH cremone bolt set for double
leaf windows - outward opening
Gratz mechanism with removable handle*

AC 2684E.S

Kit cremone sx per finestre
a due ante - apertura esterna
Gratz con maniglia removibile
*LH cremone bolt set for double leaf
windows - outward opening
Gratz mechanism with removable handle*

**AC 2683.D**

Kit cremone dx per finestre
ad un'anta - apertura esterna

*RH cremone bolt set for single leaf
windows - outward opening*

AC 2683.S

Kit cremone sx per finestre
ad un'anta - apertura esterna

*LH cremone bolt set for single leaf
windows - outward opening*

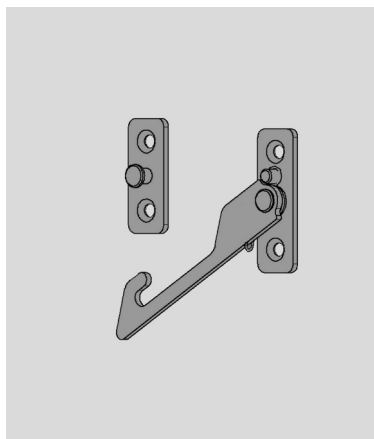
**AC 2685.D**

Limitatore di apertura per aereazione
APR interna dx | APR esterna sx

*Window ventilation restrictor
RH inward oPR | LH outward oPR*

AC 2685.S

Limitatore di apertura per aereazione
APR interna sx | APR esterna dx

*Window ventilation restrictor
LH inward oPR | RH outward oPR*

**AC 2683E.D**

Kit cremone dx per finestre
ad un'anta - apertura esterna
Gratz con maniglia removibile
*RH cremone bolt set for single leaf
windows - outward opening
Gratz mechanism with removable handle*

AC 2683E.S

Kit cremone sx per finestre
ad un'anta - apertura esterna
Gratz con maniglia removibile
*LH cremone bolt set for single leaf
windows - outward opening
Gratz mechanism with removable handle*

**AC 2686**

Braccetto limitatore di apertura
frizionato

Window restrictor

**AC 2687**

Braccetto limitatore di apertura
esterna finestra con blocco

*Casement stay
outward opening*

**AC 2693**

Serratura con scrocco e
catenaccio

Latch and bolt lock

**AC 2688**

Coppia compassi
apertura a sporgere
Peso massimo anta 100 kg

*Pair of side arms for
awning opening
Max leaf weight 100 kg*

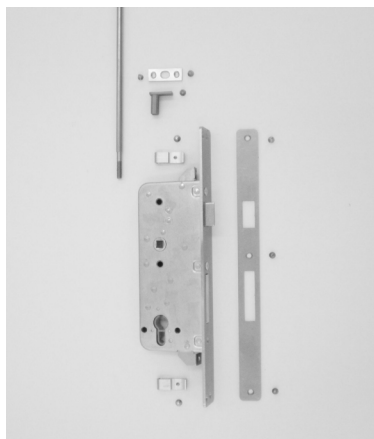
**AC 2694.D**

Kit serratura multipunto dx
per porta

RH Multi-lock set for door

AC 2694.S

Kit serratura multipunto sx
per porta

LH Multi-lock set for door

Vedi pg. 4.5.25 per la scelta
For the choice see pg. 4.5.25

**AC 2689**

Coppia compassi
apertura a sporgere
Peso massimo anta 40 kg

*Pair of side arms for
awning opening
Max leaf weight 40 kg*

**AC 2695.D**

Punto di chiusura aggiuntivo
dx per porta

RH additional locking point for door

AC 2695.S

Punto di chiusura aggiuntivo
sx per porta

LH additional locking point for door

Vedi pg. 4.5.27 per la scelta
For the choice see pg. 4.5.27

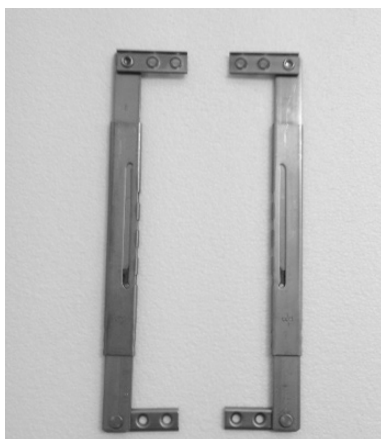
**AC 2690**

Braccetti limitatori
apertura a sporgere

*Casement stays for
awning opening*

**AC 2696.xx**

Scatola copri serratura
Destra

RH lock cover box

AISI 304

ZN acciaio zincato | *galvanized steel*
CZ acciaio corten | *corten steel*
IZ acciaio inox | *stainless steel*
BR ottone naturale | *natural brass*

Vedi pg. 4.5.25 per la scelta
For the choice see pg. 4.5.25

AISI 304

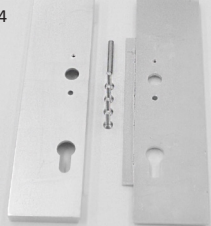

ZN acciaio zincato | *galvanized steel*
CZ acciaio corten | *corten steel*
IZ acciaio inox | *stainless steel*
BR ottone naturale | *natural brass*

AC 2697.xx

Scatola copri serratura
Sinistra

LH lock cover box

Vedi pg. 4.5.25 per la scelta
For the choice see pg. 4.5.25

AG 2580

Coppia di cerniere a scomparsa
per vasistas su profilo PR2543
Peso max anta 70 kg

*Pair of concealed hinges for
bottom hung window
on PR2543 profile
Max leaf weight 70 kg*

**AG 1386**

Limitatore di apertura frizionato
per meccanismi A/R a scomparsa
Solo per meccanismi EASY

*Friction stay for tilt-turn
mechanism, concealed hinges
Only for EASY mechanism*

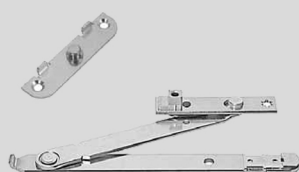
**AG 6530**

Limitatore di corsa per
meccanismi A/R

*Opening limiter on tilt&turn
mechanism*

**AG 2524**

Cerniera a tre ali ad avvitare per
vasistas con profilo PR2543
Peso max anta 70 kg

*Screw-on hinge for bottom-hung
window with PR2543 profile
Max leaf weight 70 kg*

Solo con profilo telaio PR2513
Only with frame profile PR2513

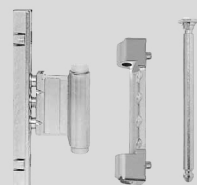
**CV 1023**

Vite per boccia fermavetri
in alluminio, TPS 4.2x13

*Screw for aluminium glazing
bead bushing, TPS 4.2x13*



CV1023 acciaio zincato | *galvanized steel*
CV1023I acciaio inox | *stainless steel*

AG 1224C.xx

Kit copertine in plastica per
cerniere AG 2524

Plastic cover for hinges AG 2524

AG1224C.AG argento | *matt silver*
AG1224C.MC marrone | *brown*
AG1224C.BC bronzato chiaro | *light bronze plated*
AG1224C.BO ottonato opaco | *matt brass plated*
AG1224C.OL ottonato lucido | *brass plated*
AG1224C.NI nichelato | *nickel*
AG1224C.WB bianco RAL 9001 | *white RAL 9001*
AG1224C.WC bianco RAL 9010 | *white RAL 9010*

**CV 1242**

Vite trilobata
TPS M4x6

*Thread cutting machine screw
TPS M4x6*



CV1242 acciaio zincato | *galvanized steel*
CV1242I acciaio inox | *stainless steel*

**CV 1243**

Vite trilobata
TPS M4x8

*Thread cutting machine screw
TPS M4x8*

CV1243 acciaio zincato | *galvanized steel*
CV1243I acciaio inox | *stainless steel*

**CV 1244**

Vite trilobata
TPS M4x12

*Thread cutting machine screw
TPS M4x12*

CV1244 acciaio zincato | *galvanized steel*
CV1244I acciaio inox | *stainless steel*

**CV 1271**

Vite trilobata
TPS M4x16

*Thread cutting machine screw
TPS M4x16*

CV1271 acciaio zincato | *galvanized steel*
CV1271I acciaio inox | *stainless steel*

**CV 5012**

Boccola per fermavetri in
alluminio

*Bushing for aluminium
glazing bead*

CV5012 acciaio zincato | *galvanized steel*
CV5012I acciaio inox | *stainless steel*

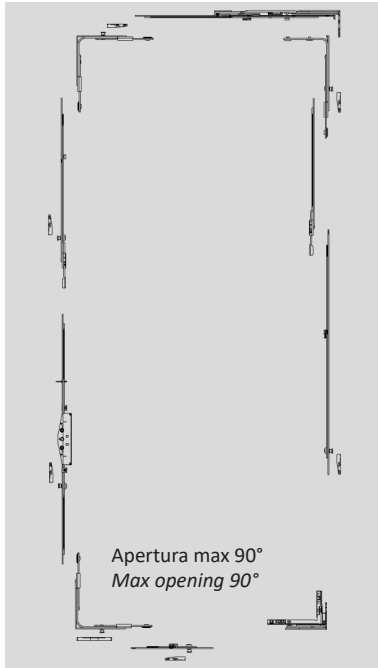
**AGE 581.xx**

Meccanismo A/R prima anta Dx cerniere a scomparsa

First leaf RH tilt-turn mechanism with concealed hinges

EASY

AGE 582.xx

Meccanismo A/R prima anta Sx cerniere a scomparsa

First leaf LH tilt-turn mechanism with concealed hinges

EASY

		altezza - height								
		670	861	1001	1201	1401	1601	1801	2001	2201
		860	1000	1200	1400	1600	1800	2000	2200	2400
larghezza width	601-800	A1	B1	C1	D1	E1	F1	G1	H1	I1
	801-1000	-	B2	C2	D2	E2	F2	G2	H2	I2
	1001-1200	-	-	C3	D3	E3	F3	G3	H3	I3
	1201-1400	-	-	-	D4	E4	F4	G4	H4	I4

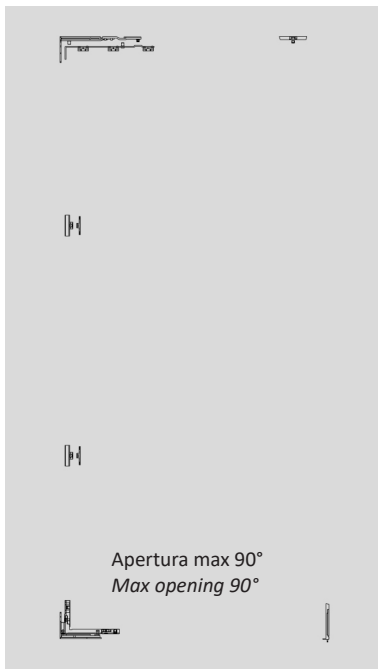
Limiti dimensionali | LimitsPeso massimo anta | *Maximum leaf weight: 130 kg*misure cava ferramenta - H>L | *hardware measure - H>W***AGE 585.xx**

Meccanismo A/R seconda anta Dx cerniere a scomparsa

Second leaf RH tilt-turn mechanism with concealed hinges

EASY

AGE 586.xx

Meccanismo A/R seconda anta Sx cerniere a scomparsa

Second leaf LH tilt-turn mechanism with concealed hinges

EASY

		altezza - height								
		670	861	1001	1201	1401	1601	1801	2001	2201
		860	1000	1200	1400	1600	1800	2000	2200	2400
larghezza width	601-800	A1	B1	C1	D1	E1	F1	G1	H1	I1
	801-1000	-	B2	C2	D2	E2	F2	G2	H2	I2
	1001-1200	-	-	C3	D3	E3	F3	G3	H3	I3
	1201-1400	-	-	-	D4	E4	F4	G4	H4	I4

Limiti dimensionali | LimitsPeso massimo anta | *Maximum leaf weight: 130 kg*misure cava ferramenta - H>L | *hardware measure - H>W*

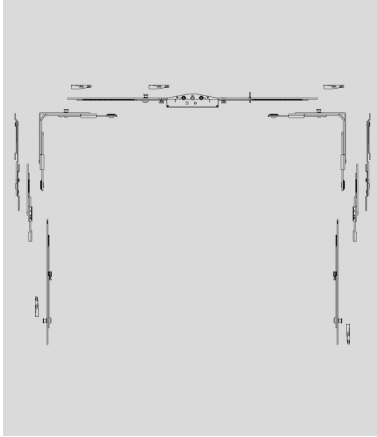
**AG 2574.xx**

Meccanismo vasistas con cremonese su traverso superiore

Bottom hung window with cremonese bolt set on the top-rail

EASY

altezza - height

		430	661	861	1201
		660	860	1200	1400
larghezza	670-860	A2	B2	C2	D2
width	861-1200	A3	B3	C3	D3

Limiti dimensionali | Limits

Peso massimo anta | *Maximum leaf weight: 70-100 kg*

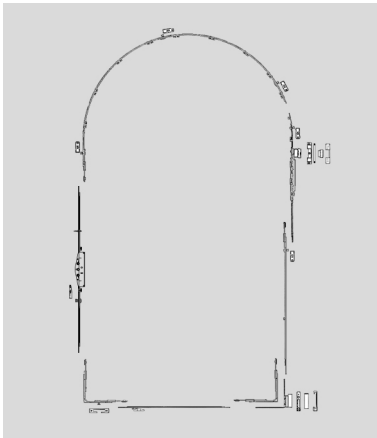
**AG 2578**

Meccanismo A/R curvo ad una o due ante con cerniere a vista (specificare all'ordine misure cava ferramenta e mano di apertura)

Tilt-turn mechanism with visible hinges for arched windows (Specify hardware slot size and the opening)

EASY

Solo con profilo telaio PR2513
Only with frame profile PR2513

Limiti dimensionali | Limits

Peso massimo anta | *Maximum leaf weight: 80 kg*

Larghezza massima | *Maximum width: 1200 mm*

Altezza massima arco reale | *Maximum height arch: 1900 mm*

Altezza massima arco ribassato | *Maximum height segmental arch: 2400 mm*

**AG 1278C.xx**

Kit copertine destre in plastica per kit A/R AG 2578

Plastic right-cover kit for tilt&turn for kit AG 2578

AG127-C.AG argento | *matt silver*
AG127-C.MC marrone | *brown*
AG127-C.BC bronzato chiaro | *light bronze plated*
AG127-C.BO ottonato opaco | *matt brass plated*
AG127-C.OL ottonato lucido | *brass plated*
AG127-C.IS inox | *stainless steel*
AG127-C.NI nichelato | *nickel*
AG127-C.WB bianco RAL 9001 | *white RAL 9001*
AG127-C.WC bianco RAL 9010 | *white RAL 9010*

AG 1279C.xx

Kit copertine sinistre in plastica per kit A/R AG 2578

Plastic left-cover kit for tilt&turn for kit AG 2578

**AC 2801I**

Kit squadrette allineamento

Alignment bracket set

Profili | Profiles
 PR2901 | PR2901 - PR2922
 PR2901 - PR2903 | PR2901 - PR2905
 PR2903 - PR2922 | PR2901 - PR2942
 PR2903 - PR2942 | PR2905 - PR2942
 PR2942 | PR2915 - P2942
 PR2961 | PR2961 - PR2963
 PR2962 - PR2963 telaio | frame

**AC 2805IR**

Kit squadrette allineamento

Alignment bracket set

Profili | Profiles
 PR2505

**AC 2803I**

Kit squadrette allineamento

Alignment bracket set

Profili | Profiles
 PR2903
 PR2915
 PR2963
 PR2965 - PR2963

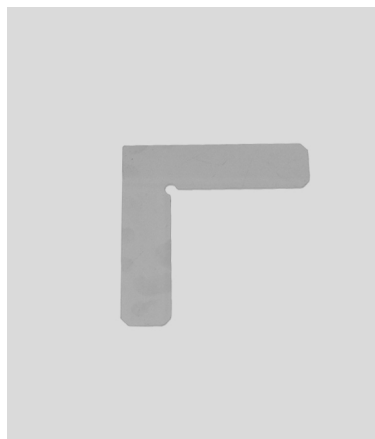
**AC 2811IR**

Kit squadrette allineamento

Alignment bracket set

Profili | Profiles
 PR2511

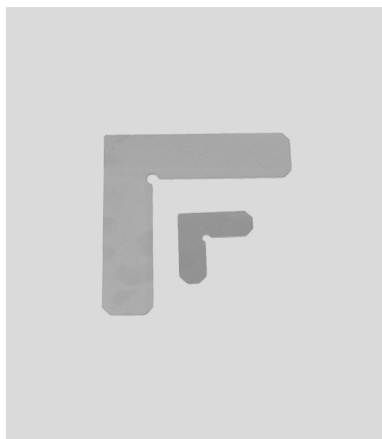
**AC 2803IR**

Kit squadrette allineamento

Alignment bracket set

Profili | Profiles
 PR2503 | PR2513 | PR2542
 PR2542 - 2543*

* Utilizzare solo la squadretta di allineamento esterna

**Use only the external alignment bracket*

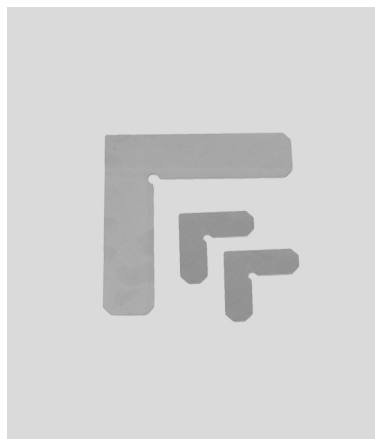
**AC 2815IR**

Kit squadrette allineamento

Alignment bracket set

Profili | Profiles
 PR2515

**AC 2805I**

Kit squadrette allineamento

Alignment bracket set

Profili | Profiles
 PR2905
 PR2985

**AC 2822I**

Kit squadrette allineamento

Alignment bracket set

Profili | Profiles
 PR2922
 PR2905 - PR2922
 PR2982
 PR2985 - PR2982

**AC 2855I**

Kit squadrette allineamento

*Alignment bracket set*Profili | Profiles
PR2955
PR2974**AC 2872I**

Kit squadrette allineamento

*Alignment bracket set*Profili | Profiles
PR2972**AC 2862I**

Kit squadrette allineamento

*Alignment bracket set*Profili | Profiles
PR2962**AC 2875I**

Kit squadrette allineamento

*Alignment bracket set*Profili | Profiles
PR2975**AC 2865I**

Kit squadrette allineamento

*Alignment bracket set*Profili | Profiles
PR2965**AC 2891I**

Kit squadrette allineamento

*Alignment bracket set*Profili | Profiles
PR2991**AC 2871I**

Kit squadrette allineamento

*Alignment bracket set*Profili | Profiles
PR2971**AC 2892I**

Kit squadrette allineamento

*Alignment bracket set*Profili | Profiles
PR2992
PR2993

**AC 2855I**

Kit squadrette allineamento

*Alignment bracket set*Profili | Profiles
PR2955
PR2974**AC 2872I**

Kit squadrette allineamento

*Alignment bracket set*Profili | Profiles
PR2972**AC 2862I**

Kit squadrette allineamento

*Alignment bracket set*Profili | Profiles
PR2962**AC 2875I**

Kit squadrette allineamento

*Alignment bracket set*Profili | Profiles
PR2975**AC 2865I**

Kit squadrette allineamento

*Alignment bracket set*Profili | Profiles
PR2965**AC 2891I**

Kit squadrette allineamento

*Alignment bracket set*Profili | Profiles
PR2991**AC 2871I**

Kit squadrette allineamento

*Alignment bracket set*Profili | Profiles
PR2971**AC 2892I**

Kit squadrette allineamento

*Alignment bracket set*Profili | Profiles
PR2992
PR2993

**AC 2895I**

Kit squadrette allineamento

*Alignment bracket set*Profili | *Profiles*
PR2995

**ACV 771.xx**

Martellina cremonese
"VITRUVIO" small
per finestra
T | tonda | tronca

*Cremone handle
small "VITRUVIO"
for window
T | cut | round*

BR ottone grezzo verniciabile | paintable untreated brass
BB ottone brunito | burnished brass
CL ottone cromo lucido | polished and chromed brass
OL ottone lucido | polished brass
SB acciaio inox scotch brite | scotch-brite stainless steel

**ACV 776.xx**

Martellina cremonese
"VITRUVIO"
per finestra
KIDS

*Cremone handle
small "VITRUVIO"
for window
KIDS*

BR ottone grezzo verniciabile | paintable untreated brass
BB ottone brunito | burnished brass
CL ottone cromo lucido | polished and chromed brass
OL ottone lucido | polished brass

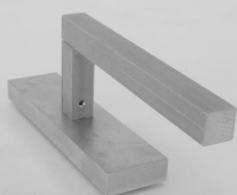
**ACV 772.xx**

Martellina cremonese
"VITRUVIO" small
per finestra
L | quadra | tronca

*Cremone handle
small "VITRUVIO"
for window
L | cut | square*

IZ inox grezzo verniciabile | paintable stainless steel
CZ acciaio corten grezzo | untreated corten steel
SB acciaio inox scotch brite | scotch-brite stainless steel

**ACV 777.xx**

Martellina cremonese
"VITRUVIO"
per finestra
OVALE

*Cremone handle
small "VITRUVIO"
for window
OVAL*

BR ottone grezzo verniciabile | paintable untreated brass
BB ottone brunito | burnished brass
CL ottone cromo lucido | polished and chromed brass
OL ottone lucido | polished brass

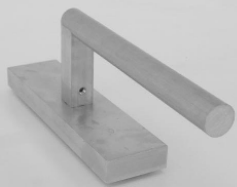
**ACV 773.xx**

Martellina cremonese
"VITRUVIO" small
per finestra
L | tonda | tronca

*Cremone handle
small "VITRUVIO"
for window
L | cut | round*

BR ottone grezzo verniciabile | paintable untreated brass
BB ottone brunito | burnished brass
CL ottone cromo lucido | polished and chromed brass
OL ottone lucido | polished brass
SB acciaio inox scotch brite | scotch-brite stainless steel

**ACV 779.xx**

Martellina cremonese
"VITRUVIO" small
per finestra
T | tonda | sfera

*Cremone handle
small "VITRUVIO"
for window
T | sphere | round*

BR ottone grezzo verniciabile | paintable untreated brass
BB ottone brunito | burnished brass
CL ottone cromo lucido | polished and chromed brass
OL ottone lucido | polished brass

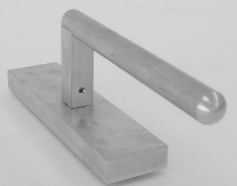
**ACV 774.xx**

Martellina cremonese
"VITRUVIO" small
per finestra
L | tonda | sfera

*Cremone handle
small "VITRUVIO"
for window
L | sphere | round*

BR ottone grezzo verniciabile | paintable untreated brass
BB ottone brunito | burnished brass
CL ottone cromo lucido | polished and chromed brass
OL ottone lucido | polished brass

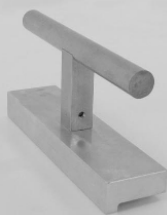
**ACV 781.xx**

Martellina cremonese
"VITRUVIO" small
per finestra ad un'anta
PR2933
T | tonda | tronca

*Cremone handle
small "VITRUVIO"
for single leaf window
PR2933
T | cut | round*

BR ottone grezzo verniciabile | paintable untreated brass
BB ottone brunito | burnished brass
CL ottone cromo lucido | polished and chromed brass
OL ottone lucido | polished brass
SB acciaio inox scotch brite | scotch-brite stainless steel

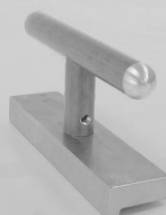
**ACV 786.xx**

Martellina cremonese
"VITRUVIO" small
per finestra a un'anta
PR2933
KIDS

*Cremone handle
small "VITRUVIO"
for single leaf window
PR2933
KIDS*

BR ottone grezzo verniciabile | paintable untreated brass
BB ottone brunito | burnished brass
CL ottone cromo lucido | polished and chromed brass
OL ottone lucido | polished brass

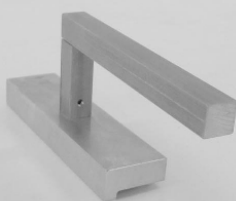
**ACV 782.xx**

Martellina cremonese
"VITRUVIO" small
per finestra a un'anta
PR2933
L | quadra | tronca

*Cremone handle
small "VITRUVIO"
for single leaf window
PR2933
L | cut | square*

IZ inox grezzo verniciabile | paintable stainless steel
CZ acciaio corten grezzo | untreated corten steel
SB acciaio inox scotch brite | scotch-brite stainless steel

**ACV 787.xx**

Martellina cremonese
"VITRUVIO" small
per finestra a un'anta
PR2933
OVALE

*Cremone handle
small "VITRUVIO"
for single leaf window
PR2933
OVAL*

BR ottone grezzo verniciabile | paintable untreated brass
BB ottone brunito | burnished brass
CL ottone cromo lucido | polished and chromed brass
OL ottone lucido | polished brass

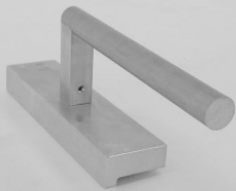
**ACV 783.xx**

Martellina cremonese
"VITRUVIO" small
per finestra a un'anta
PR2933
L | tonda | tronca

*Cremone handle
small "VITRUVIO"
for single leaf window
PR2933
L | cut | round*

BR ottone grezzo verniciabile | paintable untreated brass
BB ottone brunito | burnished brass
CL ottone cromo lucido | polished and chromed brass
OL ottone lucido | polished brass
SB acciaio inox scotch brite | scotch-brite stainless steel

**ACV 789.xx**

Martellina cremonese
"VITRUVIO" small
per finestra a un'anta
PR2933
T | tonda | sfera

*Cremone handle
small "VITRUVIO"
for single leaf window
PR2933
T | sphere | round*

BR ottone grezzo verniciabile | paintable untreated brass
BB ottone brunito | burnished brass
CL ottone cromo lucido | polished and chromed brass
OL ottone lucido | polished brass

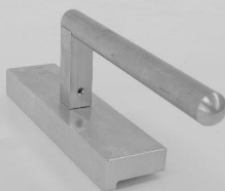
**ACV 784.xx**

Martellina cremonese
"VITRUVIO" small
per finestra a un'anta
PR2933
L | tonda | sfera

*Cremone handle
small "VITRUVIO"
for single leaf window
PR2933
L | sphere | round*

BR ottone grezzo verniciabile | paintable untreated brass
BB ottone brunito | burnished brass
CL ottone cromo lucido | polished and chromed brass
OL ottone lucido | polished brass

**AC 2556**

Meccanismo DK esterno per maniglie "Vitruvio"

External tilt and turn mechanism for "Vitruvio" handles

**ACV 673.xx**

Copertina per gratz con maniglia removibile su kit
AC2624E | AC2625E
AC2683E | AC2684E

Cover for gratz mechanism on kit
AC2624E | AC2625E
AC2683E | AC2684E

BR ottone grezzo verniciabile | *paintable untreated brass*
BB ottone brunito | *burnished brass*
CZ acciaio corten grezzo | *untreated corten steel*
SB acciaio inox scotch brite | *scotch-brite stainless steel*

**ACR 055**

Quadro riduzione per martellina DK commerciale

Spindle reducer for commercial DK handle

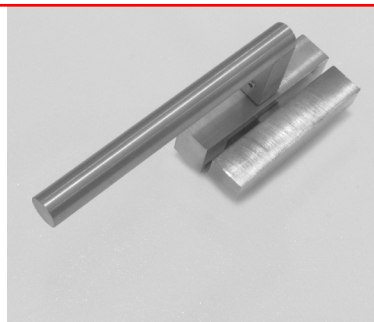
**ACV 793.xx.D**

Martellina per sporgere dx "VITRUVIO" small
L | tonda | tronca
RH Cockscur handle
"VITRUVIO" small
L | round | cut

ACV 793.xx.S

Martellina per sporgere sx "VITRUVIO" small
L | tonda | tronca
LH Cockscur handle
"VITRUVIO" small
L | round | cut

BR ottone grezzo verniciabile | *paintable untreated brass*
BB ottone brunito | *burnished brass*
SB acciaio inox scotch brite | *scotch-brite stainless steel*

**ACV 065**

Quadro maniglia

Handle spindle bar

**ACV 658.xx**

Copertina per gratz con maniglia removibile su kit
AC2623E

Cover for gratz mechanism on kit
AC2623E

BR ottone grezzo verniciabile | *paintable untreated brass*
BB ottone brunito | *burnished brass*
CZ acciaio corten grezzo | *untreated corten steel*
SB acciaio inox scotch brite | *scotch-brite stainless steel*

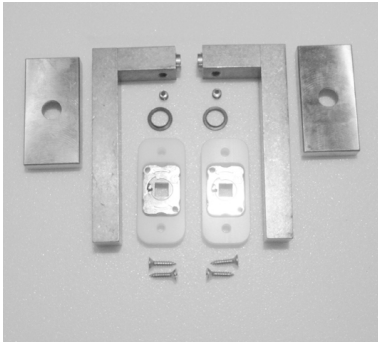
**ACV 952.xx**

Coppia maniglie per porta
"VITRUVIO" medium
bocchetta rettangolare
L | quadra | tronca

*Double door handlesets
"VITRUVIO" medium
rectangular escutcheon
L | square | cut*

IZ inox grezzo verniciabile | *paintable stainless steel*
CZ acciaio corten grezzo | *untreated corten steel*
SB acciaio inox scotch brite | *scotch-brite stainless steel*

**ACV 953.xx**

Coppia maniglie per porta
"VITRUVIO" medium
bocchetta rettangolare
L | tonda | tronca

*Double door handlesets
"VITRUVIO" medium
rectangular escutcheon
L | round | cut*

BR ottone grezzo verniciabile | *paintable untreated brass*
BB ottone brunito | *burnished brass*
CL ottone cromo lucido | *polished and chromed brass*
OL ottone lucido | *polished brass*
SB acciaio inox scotch brite | *scotch-brite stainless steel*

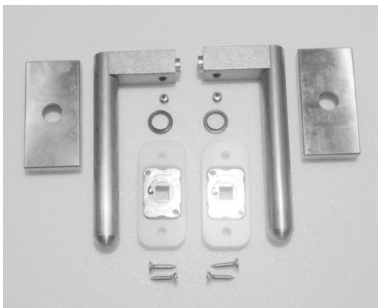
**ACV 954.xx**

Coppia maniglie per porta
"VITRUVIO" medium
bocchetta rettangolare
L | tonda | sfera

*Double door handlesets
"VITRUVIO" medium
rectangular escutcheon
L | round | sphere*

BR ottone grezzo verniciabile | *paintable untreated brass*
BB ottone brunito | *burnished brass*
CL ottone cromo lucido | *polished and chromed brass*
OL ottone lucido | *polished brass*

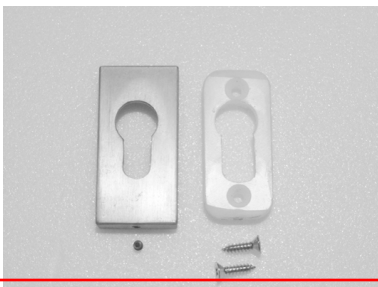
**ACV 964.xx**

Bocchetta copri cilindro a profilo
europeo

*Euro profile cylinder escutcheon
plate*

BR ottone grezzo verniciabile | *paintable untreated brass*
BB ottone brunito | *burnished brass*
CL ottone cromo lucido | *polished and chromed brass*
OL ottone lucido | *polished brass*
CZ acciaio corten grezzo | *untreated corten steel*
SB acciaio inox scotch brite | *scotch-brite stainless steel*

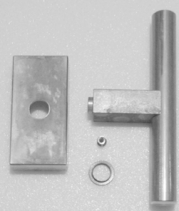
**ACV 971.xx**

Maniglia per DK
finestra "VITRUVIO" medium
T | tonda | tronca

DK window handle
"VITRUVIO" medium
T | round | cut

BR ottone grezzo verniciabile | *paintable untreated brass*
BB ottone brunito | *burnished brass*
CL ottone cromo lucido | *polished and chromed brass*
OL ottone lucido | *polished brass*
SB acciaio inox scotch brite | *scotch-brite stainless steel*

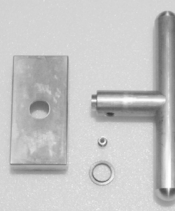
**ACV 976.xx**

Maniglia per DK finestra
"VITRUVIO" medium
KIDS

DK window handle
"VITRUVIO" medium
KIDS

BR ottone grezzo verniciabile | *paintable untreated brass*
BB ottone brunito | *burnished brass*
CL ottone cromo lucido | *polished and chromed brass*
OL ottone lucido | *polished brass*

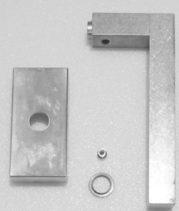
**ACV 972.xx**

Maniglia per DK finestra
"VITRUVIO" medium
L | quadra | tronca

DK window handle
"VITRUVIO" medium
L | square | cut

IZ inox grezzo verniciabile | *paintable stainless steel*
CZ acciaio corten grezzo | *untreated corten steel*
SB acciaio inox scotch brite | *scotch-brite stainless steel*

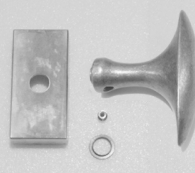
**ACV 977.xx**

Maniglia per DK finestra
"VITRUVIO" medium
OVALE

DK window handle
"VITRUVIO" medium
OVALE

BR ottone grezzo verniciabile | *paintable untreated brass*
BB ottone brunito | *burnished brass*
CL ottone cromo lucido | *polished and chromed brass*
OL ottone lucido | *polished brass*

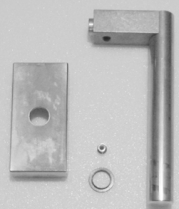
**ACV 973.xx**

Maniglia per DK finestra
"VITRUVIO" medium
L | tonda | tronca

DK window handle
"VITRUVIO" medium
L | round | cut

BR ottone grezzo verniciabile | *paintable untreated brass*
BB ottone brunito | *burnished brass*
CL ottone cromo lucido | *polished and chromed brass*
OL ottone lucido | *polished brass*
SB acciaio inox scotch brite | *scotch-brite stainless steel*

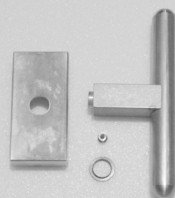
**ACV 979.xx**

Maniglia per DK finestra
"VITRUVIO" medium
T | tonda | sfera

DK window handle
"VITRUVIO" medium
T | round | sphere

BR ottone grezzo verniciabile | *paintable untreated brass*
BB ottone brunito | *burnished brass*
CL ottone cromo lucido | *polished and chromed brass*
OL ottone lucido | *polished brass*

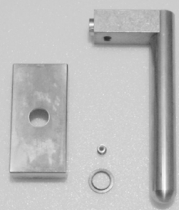
**ACV 974.xx**

Maniglia per DK finestra
"VITRUVIO" medium
L | tonda | sfera

DK window handle
"VITRUVIO" medium
L | round | sphere

BR ottone grezzo verniciabile | *paintable untreated brass*
BB ottone brunito | *burnished brass*
CL ottone cromo lucido | *polished and chromed brass*
OL ottone lucido | *polished brass*

METALFORM

MASTERS OF METAL

UNITED KINGDOM

METALFORM

NORWAYMETAL LTD

53 Chelsea Manor Street

London, SW3 5RZ

SALES@METALFORM.UK

+44 20 81298814

GERMANY

METALFORM GMBH

Carl-Zeiss-Ring 15A

85737 Ismaning

SALES@METALFORMGROUP.DE

+49 17663630406

NORWAY

METALFORM AS

Brochmannsveien 2

1950 Rømskog

SALG@METALFORM.NO

+47 401 62 446

METALFORMGROUP

SALES@METALFORMGROUP.COM