

OS2 75 AS 2.0

CATALOGO

TECNICO

TECHNICAL

CATALOGUE

METALFORM

versione 02/2022

The logo for Secco, featuring the word "secco" in white lowercase letters on a red trapezoidal background.

secco

1	Informazioni generali / General informations	
	Descrizione del sistema / <i>System description</i>	1.1.1
	Tipologie e limiti dimensionali / <i>Typologies and dimensional limits</i>	1.2.1 – 1.2.5
2	Componenti del sistema / System component	
	Profili / <i>Profiles</i>	2.1.1 – 2.1.5
	Accessori / <i>Accessories</i>	2.2.1 – 2.2.2
	Ferramenta / <i>Hardware</i>	2.3.1 – 2.3.5
	Squadrette / <i>Brackets</i>	2.4.1 - 2.4.2
	Maniglie / <i>Handles</i>	2.5.1
	Guarnizioni / <i>Gaskets</i>	2.6.1 – 2.6.2
	Attrezzature / <i>Working tools</i>	2.7.1
	Prodotti / <i>Products</i>	2.8.1 – 2.8.2
	Fermavetri / <i>Glazing beads</i>	2.9.1 – 2.9.6
3	Tecnica del sistema / System technique	
	Sezioni / <i>Sections</i>	3.1.1 – 3.1.18
	Attacchi a muro / <i>Attachment to structure</i>	3.2.1 – 3.2.9
4	Lavorazioni e ciclo produttivo / Processing plan	
	Distinte di taglio - Lista componenti / <i>Cutting list - Component list</i>	4.1.1 – 4.1.13
	Telaio - Lavorazione e applicazione accessori/ <i>Frame - Working and installation accessories</i>	4.2.1 – 4.2.27
	Anta - Lavorazione e applicazione accessori/ <i>Sash - Production cycle and processing</i>	4.3.1 – 4.3.43
	Motorizzato / <i>Automated</i>	MC.1 – MC.10
5	Note generali sul processo / Processing general informations	
	Raccomandazioni per la lavorazione / <i>Working recommendations</i>	5.1.1 – 5.1.5
	Taglio, asolature, forature / <i>Cutting, slots, holes</i>	5.2.1 – 5.2.2
	Senso di apertura / <i>Side opening</i>	5.3.1 – 5.3.2
	Controllo qualità / <i>Quality control activities</i>	5.4.1 – 5.4.3
	Materiali e finiture / <i>Material and finishing</i>	5.5.1 – 5.5.2
	Indice analitico / <i>Subject index</i>	5.6.1

OS2 75 AS 2.0 è un sistema integrato di accessori, guarnizioni e profilati a **taglio termico** aventi profondità di 84 mm e sezione in vista di 47 mm. Il sistema consente di realizzare serramenti alzanti scorrevoli da una a quattro ante, apribili e/o fisse. Il peso massimo delle singole ante è di 250 kg e il sistema installa vetri a doppia camera da 35/51 mm di spessore.

Le prestazioni di tenuta al passaggio di aria e acqua e di isolamento acustico sono ottenute grazie alla compressione dei giunti di tenuta durante la chiusura delle ante. Tali giunti sono progettati con doppia guarnizione di tenuta sui quattro lati, un dedicato profilo soglia per il drenaggio dell'acqua e speciali tamponi in gomma e neoprene posizionati alle estremità verticali del giunto centrale.

Ogni tipologia è provvista di apposita accessoristica di movimentazione e chiusura a scomparsa ed integrata al sistema con chiusure multiple: tutte le soluzioni possono essere motorizzate tramite l'installazione dei gruppi motore, dedicati e a scomparsa, che ne consentono l'alzata e lo scorrimento.

Le prestazioni del sistema a taglio termico **OS2 75 AS 2.0** sono state testate, nelle configurazioni più estreme di peso e dimensione, dai migliori Laboratori di certificazione Europei secondo le norme di riferimento EN 14351-1.

OS2 75 AS 2.0 is an integrated system of accessories, gaskets and **thermally broken** cold-rolled profiles with a nominal depth of 84 mm and visible section of 47 mm. The system allows the manufacture of lift-and-slide doors with up to four sashes openable and/or fixed. The maximum weight per sash is 250 kg, and the system can be fitted with a TGU of 35/51 mm thick.

High performance of the system in terms of air permeability, watertightness and sound reduction is achieved thanks to the compression provided by the sealing joints in closing position. These joints are designed with double sealing gaskets along all four sides, a dedicated threshold profile for water drainage and special rubber and neoprene pads positioned at the top of the central joint.

Each typology comes with a dedicated set of accessories for concealed handling and multi-locking system: all configurations can be automated by means of dedicated and concealed motor units, which allow the lifting and sliding of the system.

The performances of the thermally broken system **OS2 75 AS 2.0** have been tested in the most extreme configurations of weight and size from the best European certification laboratories according to the reference standards EN 14351-1.

PRESTAZIONI

Trasmittanza termica (UNI EN 14351/1)
- Uw fino a 1,4 W/m²K
Resistenza all'aria (UNI EN 12207)
- fino a classe 4
Resistenza all'acqua (UNI EN 12208)
- fino a classe 9A
Resistenza al vento (UNI EN 12210)
- fino a classe B3
Forze di azionamento (UNI EN 12046/1)
- Classe 1 < 100 N

PERFORMANCE

Thermal transmittance (UNI EN 14351/1)
- Uw up to 1,4 W/m²K
Air permeability (UNI EN 12207)
- up to class 4
Watertightness (UNI EN 12208)
- up to class 9A
Resistance to wind load (UNI EN 12210)
- up to class B3
Operating forces (UNI EN 12046/1)
- Class 1 < 100 N

Schema | Type A

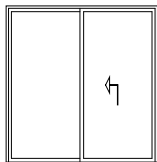

Schema | Type B

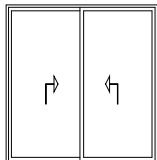

Schema | Type E

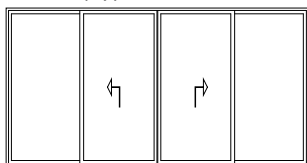

Schema | Type F

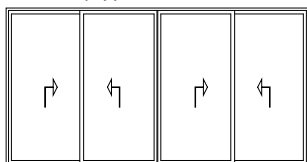

Schema | Type S1

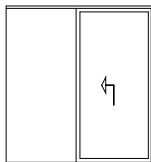

Schema | Type T1

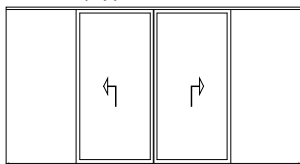

Schema | Type A 1 anta scorrevole ed 1 anta fissa
1 sliding and 1 fixed sash

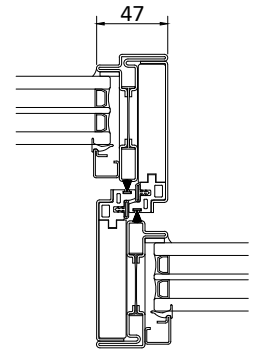
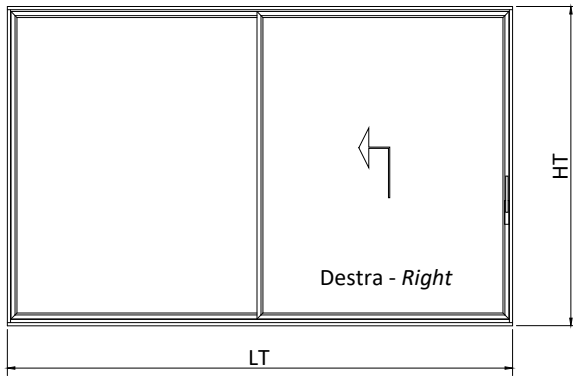

Schema | Type B 2 ante scorrevoli
2 sliding sashes

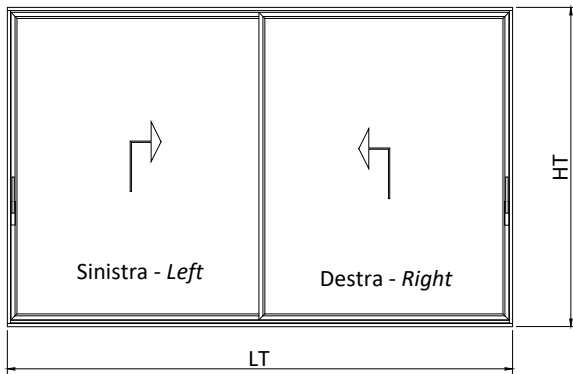

Limiti dimensionali | Dimensional limits (mm)

Telaio Frame	LT	1711 - 3131	LT
	HT	1227 - 3000	HT
Anta Sash	LA	850 - 1560	LT/2-6
	HA	1135 - 2908	HT - 92
Peso Weight	250 kg		

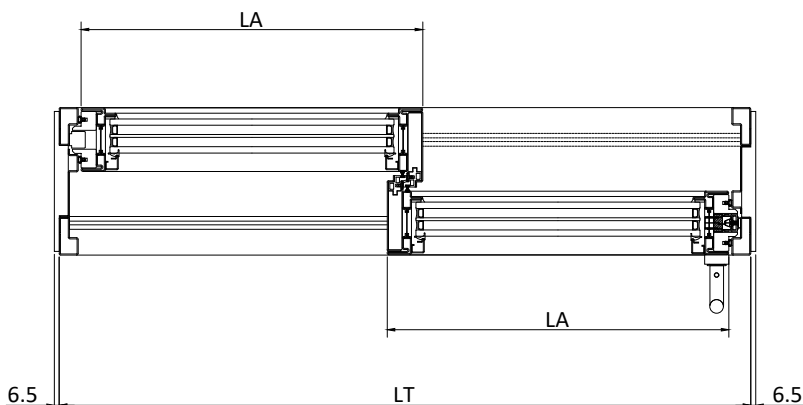
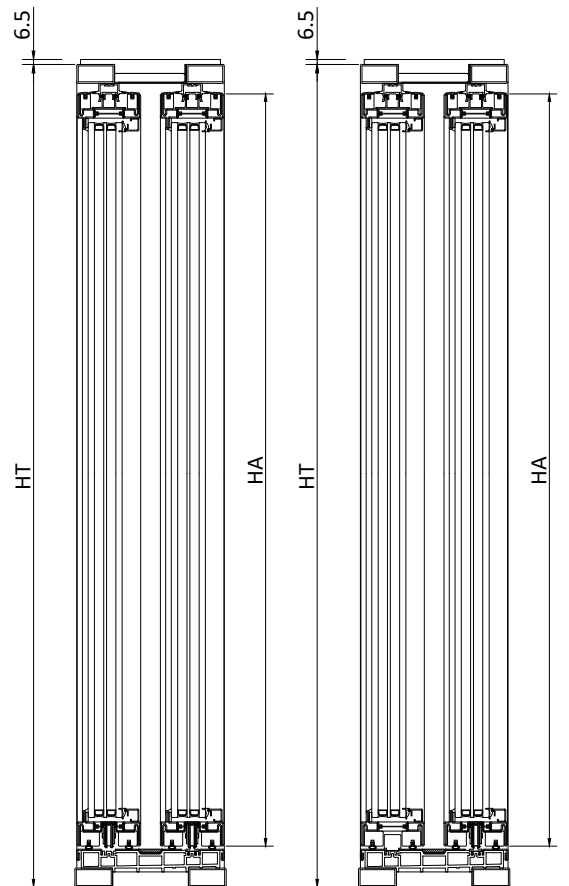

Schema | Type E 2 ante scorrevoli e 2 ante fisse
2 sliding and 2 fixed sashes

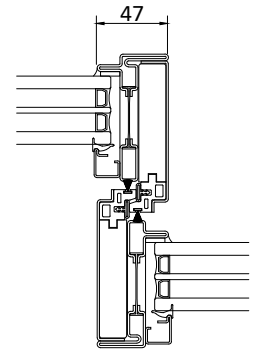
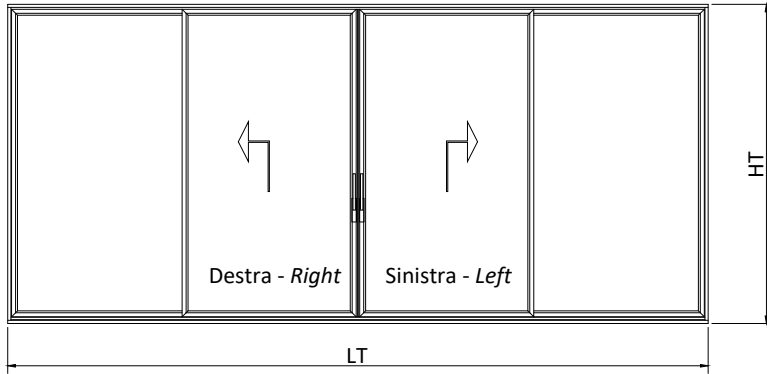

Schema | Type F 4 ante scorrevoli
4 sliding sashes

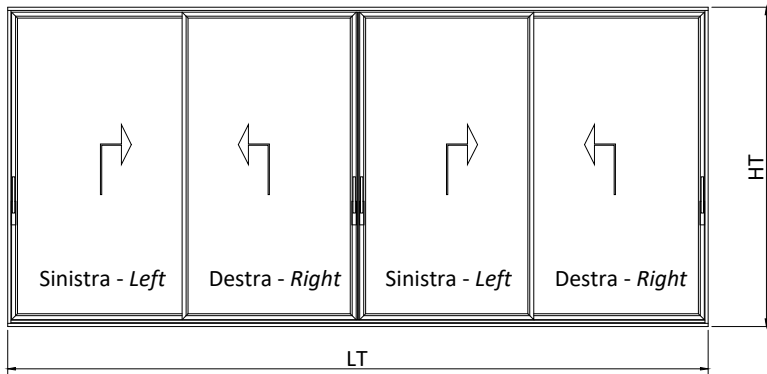

Limiti dimensionali | Dimensional limits (mm)

Telaio Frame	LT	3391 - 6231	LT
	HT	1227 - 3000	HT
Anta Sash	LA ₁	861,5 - 1571,5	LT/4+13
	LA ₂	850 - 1560	LT/4+3
	HA	1135 - 2908	HT - 92
Peso Weight	250 kg		

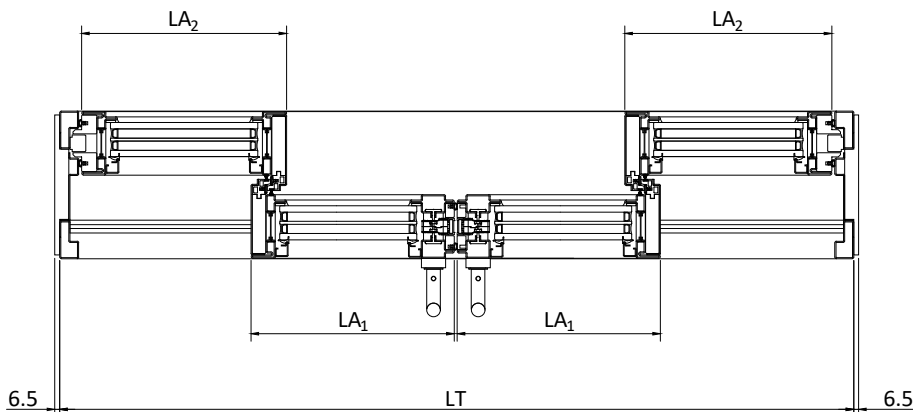
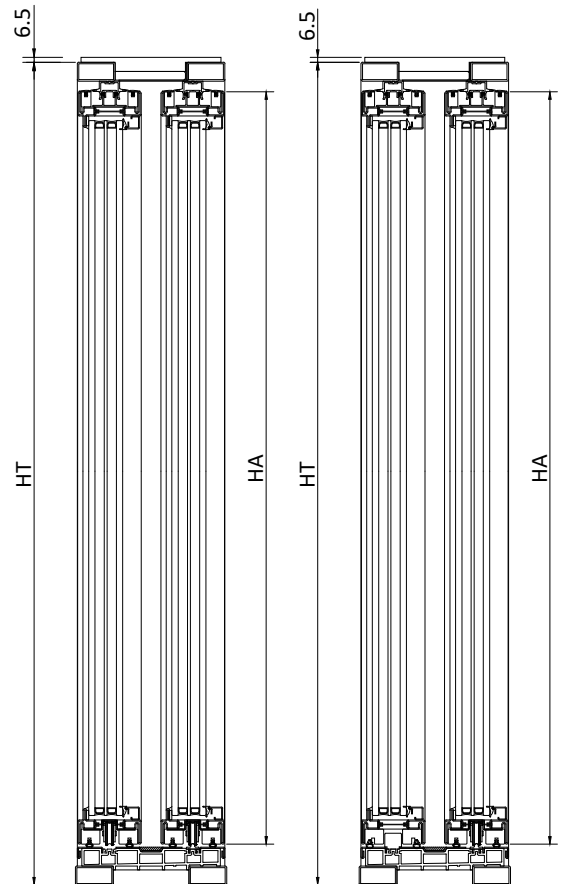

Schema | Type S1 1 anta scorrevole a scomparsa
1 sliding sash into the wall

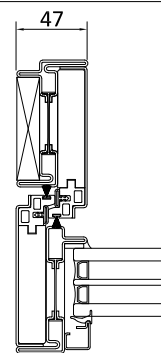
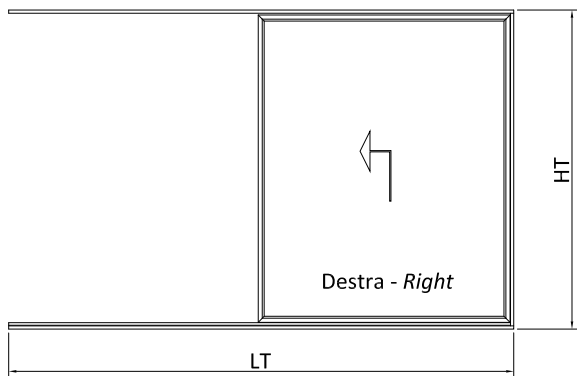

Limiti dimensionali | Dimensional limits (mm)

Telaio Frame	LT	1804 - 3224	LT
	HT	1227 - 3000	HT
Anta Sash	LA	850 - 1560	LT/2-52
	HA	1135 - 2908	HT - 92
Peso Weight		250 kg	

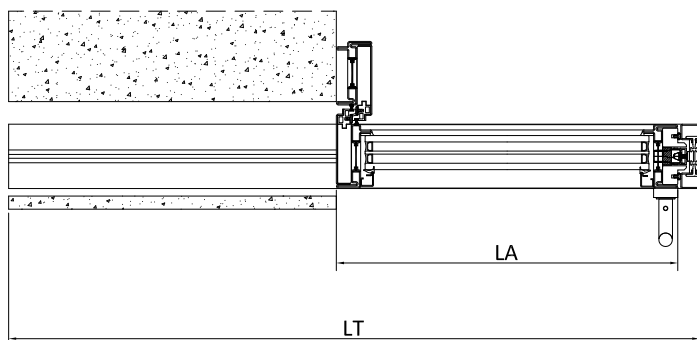
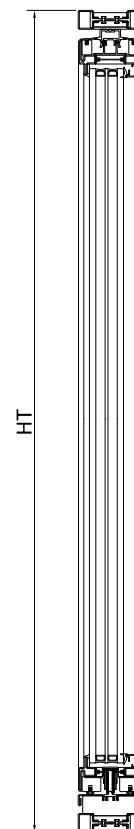

Schema | Type T1 2 ante scorrevoli coassiali a scomparsa
2 coaxial sliding sashes into the wall

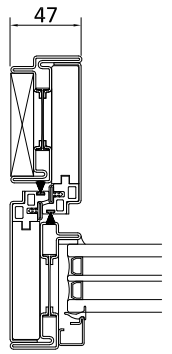
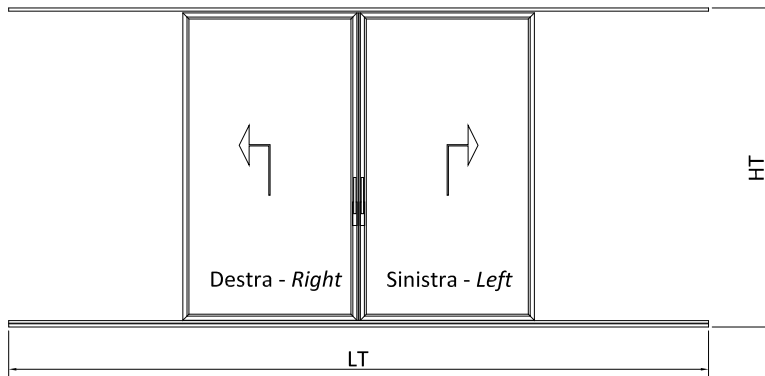

Limiti dimensionali | Dimensional limits (mm)

Telaio Frame	LT	3600 - 6440	LT
	HT	1227 - 3000	HT
Anta Sash	LA	861,5 - 1571,5	LT/4-38
	HA	1135 - 2908	HT - 92
Peso Weight	250 kg		

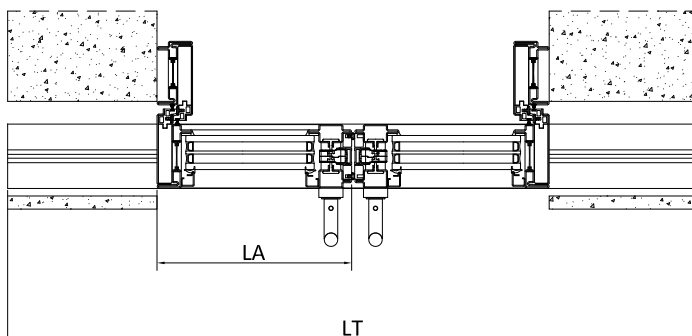
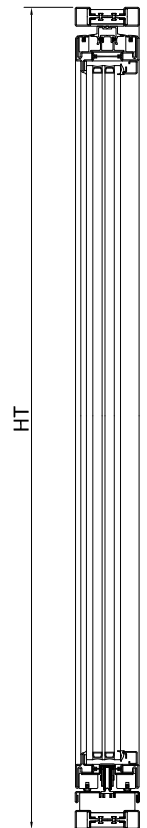

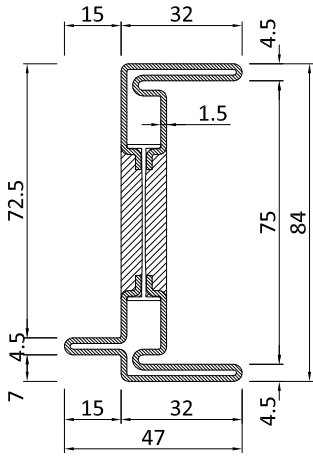

PR2975

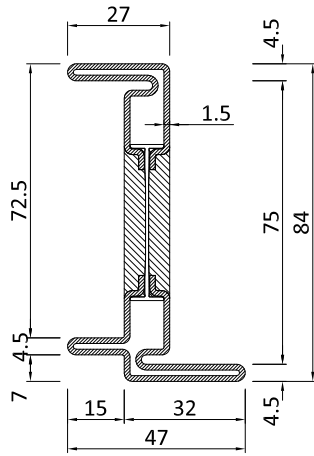

PR2975V4

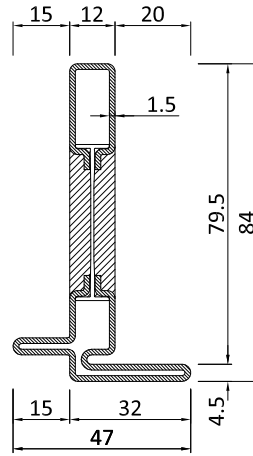

PR2988

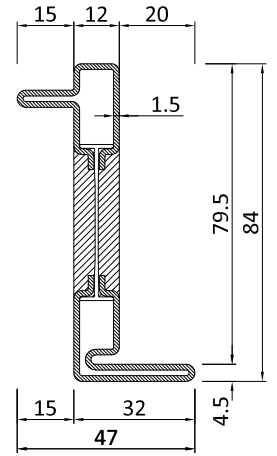

PR2989

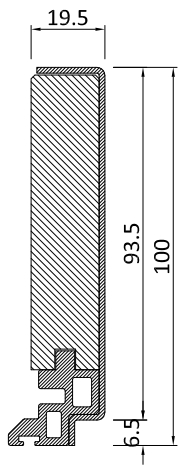

PR2946

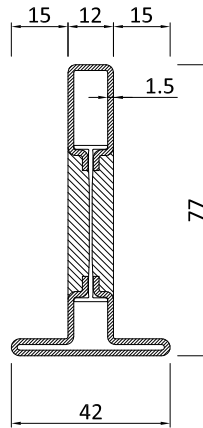

PR2952

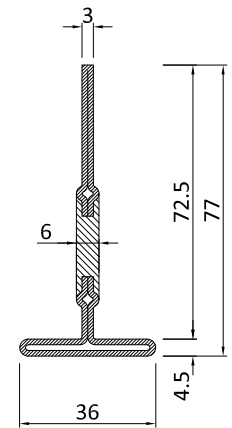

PR2954

Non fornito
in acciaio inox
Not in stainless
steel

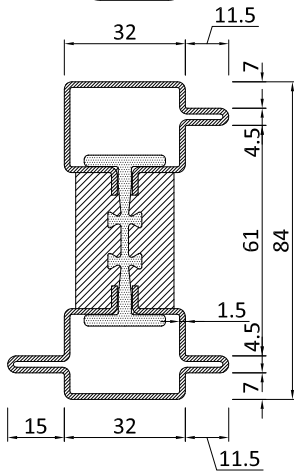

PR2995N

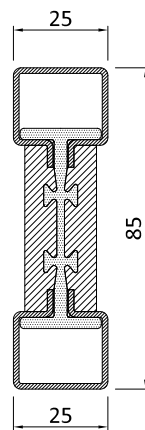

PR1320

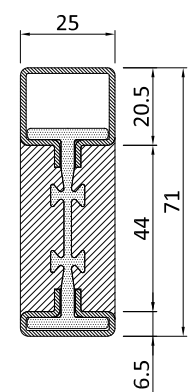

PR1320M

Profilo / Profile n°	P Kg/m		A m ² /m	Jx cm ⁴	Jy cm ⁴	L m
	ZN / I - CT	OT				
PR2975	3,52	3,77	0,32	32,75	4,36	6
PR2975V4	3.46	3,71	0,30			6
PR2988	2,96	3,17	0,27	22,26	3,03	6
PR2989	2,95	3,15	0,27	25,66	2,85	3 - 4
PR2946	3,25	3,40	0,13			3 - 4

Profilo / Profile n°	P Kg/m		A m ² /m	Jx cm ⁴	Jy cm ⁴	L m
	ZN / I - CT	OT				
PR2952	2,51	2,68	0,23	18,14	2,18	6
PR2954	2,33	2,55	0,22	19,90	1,20	6
PR2995N	4,58	4,87	0,31	29,11	10,02	3 - 4
PR1320	3,18	3,35	1,16	21,80	2,16	3 - 6
PR1320M	2,86	3,00	0,19	14,50	1,58	3

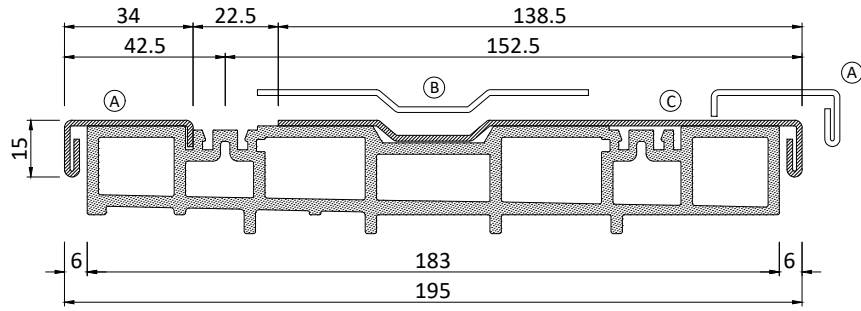

PR2983

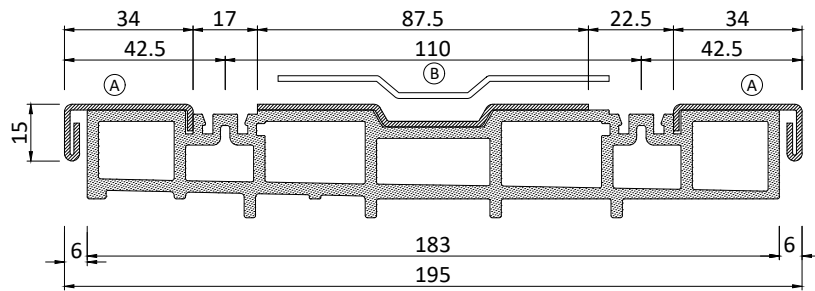
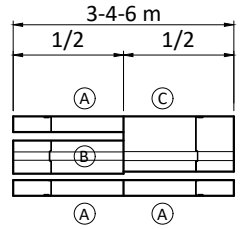

PR2984

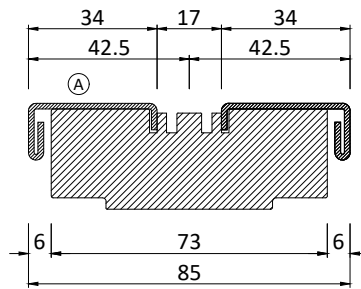
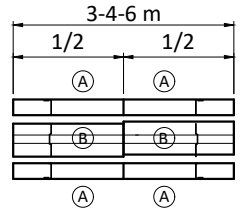

PR2981.1

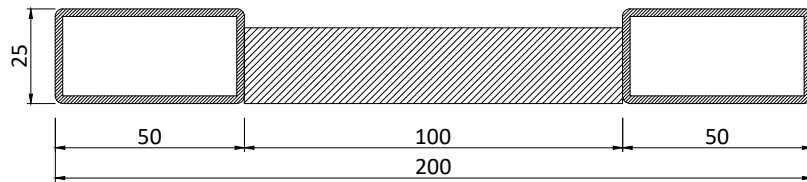
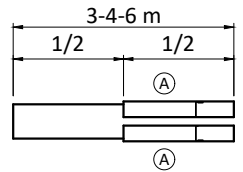

PR1195

disponibile in acciaio zincato o
acciaio inox
available in galvanized steel or
stainless steel

Profilo / Profile n°	P Kg/m		A m ² /m	Jx cm ⁴	Jy cm ⁴	L m	Profilo / Profile n°	P Kg/m		A m ² /m	Jx cm ⁴	Jy cm ⁴	L m
	ZN / I - CT	OT						ZN / I - CT	OT				
PR2983	7,30	7,65	0,25			3 - 4 - 6							
PR2984	4,70	5,10	0,25			3 - 4 - 6							
PR2981.1	7,30	7,65	0,45			3 - 4 - 6							
PR1195	6,60					3 - 4 - 6							

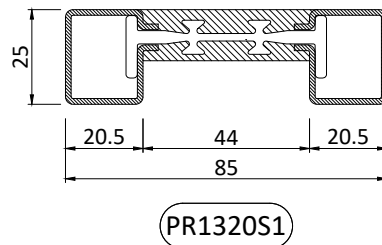
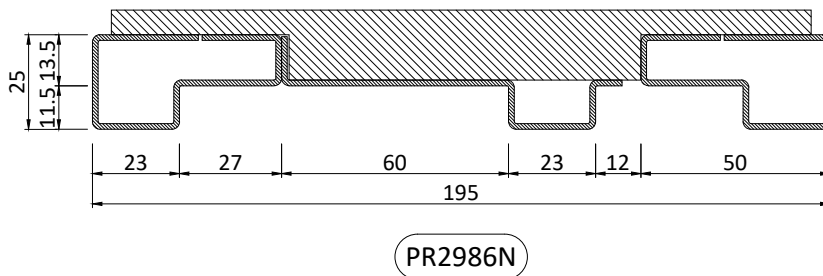
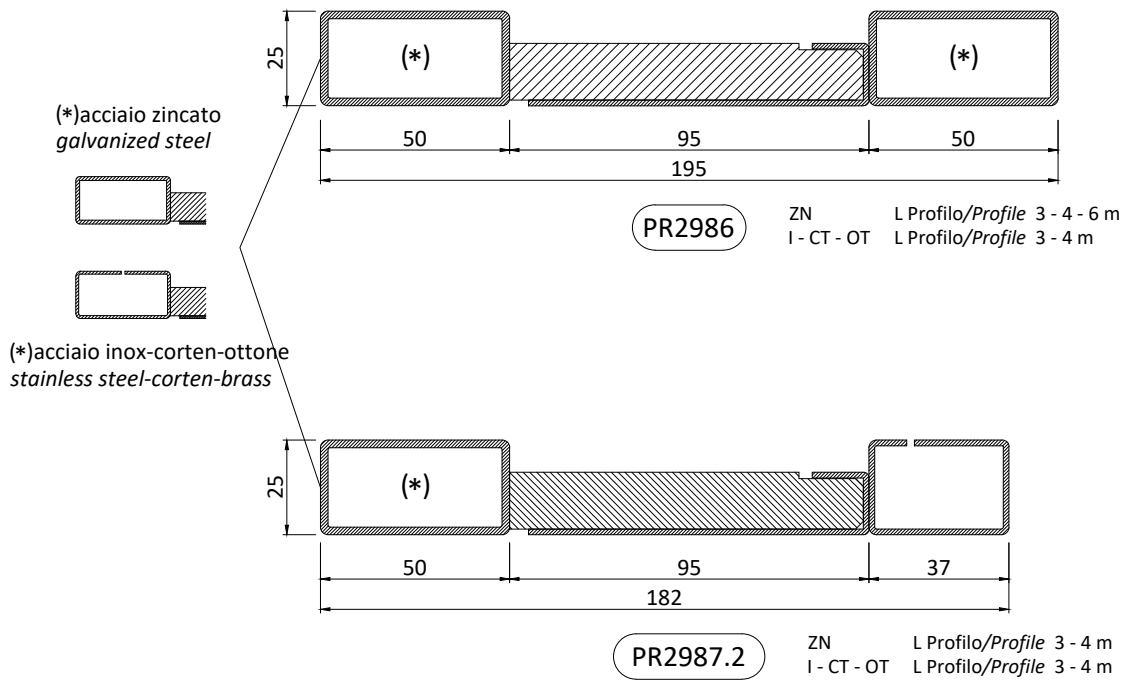

Profilo / Profile n°	P Kg/m		A m ² /m	Jx cm ⁴	Jy cm ⁴	L m	Profilo / Profile n°	P Kg/m		A m ² /m	Jx cm ⁴	Jy cm ⁴	L m
	ZN / I - CT	OT						ZN / I - CT	OT				
PR2986	7,30	7,65	0,25			3 - 4 - 6							
PR2987.2	7,25	7,60	0,40			3 - 4							
PR2986N	6,85	7,35	0,46			3 - 4							
PR1320S1	3,80	4,00	0,24			3 - 4							

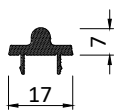

PA1194

PA1194.NE

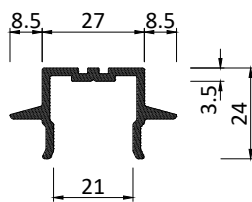

GU2955

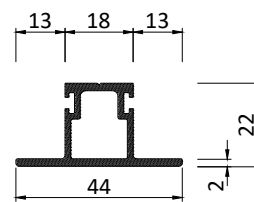

GU2956

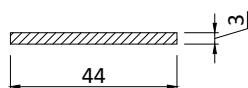

GU1311

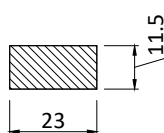

GU2988

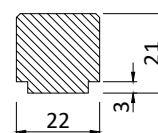

GU2905

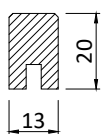

GU2975S

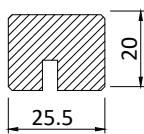

GU2985I

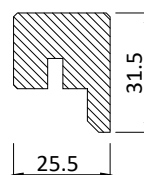

GU2985L

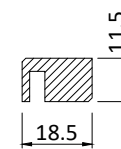

GU2995N

Profilo / Profile n°	P		A m ² /m	Jx cm ⁴	Jy cm ⁴	L m	Profilo / Profile n°	P		A m ² /m	Jx cm ⁴	Jy cm ⁴	L m
	ZN / I - CT	OT						ZN / I - CT	OT				
PA1194	0,20		alluminio argento aluminium silver			3 - 4 - 6	GU2975S	0,23	PVC				3
PA1194NE	0,20		alluminio nero aluminium black			6	GU2985I	0,47	PVC				3
GU2955	0,26		poliammide polyamide			3 - 4 - 6	GU2985L	0,53	PVC				3
GU2956	0,23		poliammide polyamide			3 - 4 - 6	GU2995N	0,23	PVC				3
GU1311	0,13	PVC				3							
GU2988	0,29	PVC				3							
GU2905	0,44	PVC				3							

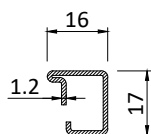

PR2606

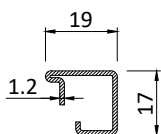

PR2607

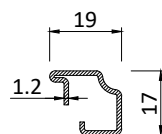

PR2627

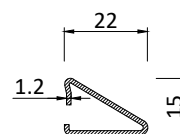

PR2629

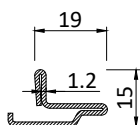

PR2638

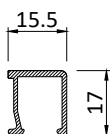

PA2606

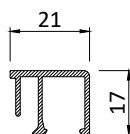

PA2607

MATERIALE | MATERIAL

PR ____ ZN acciaio zincato | *galvanized steel*PR ____ CZ acciaio corten grezzo | *untreated corteen steel*PR ____ SB acciaio inox scotch brite | *stainless steel scotch brite*PR ____ BR ottone grezzo | *untreated brass*

Profilo / Profile n°	P Kg/m		A m ² /m	Jx cm ⁴	Jy cm ⁴	L m	Profilo / Profile n°	P Kg/m		A m ² /m	Jx cm ⁴	Jy cm ⁴	L m
	ZN / 1 - CT	OT						ZN / 1 - CT	OT				
PR2606	0,48	0,52				6							
PR2607	0,51	0,55				6							
PR2627	0,47	0,51				6							
PR2629	0,49	0,53				6							
PR2638	0,60	0,68				6							
PA2606	0,17	alluminio aluminium				6							
PA2607	0,23	alluminio aluminium				6							

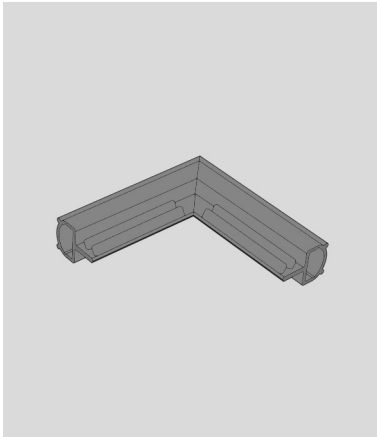
**AC1305G**

Guarnizione d'angolo
vulcanizzata per GE1305S

*Vulcanised corner weather strip
for GE1305S*

**AC2993P**

Accessorio assiemaggio telaio
PR2986

*Frame assembling accessory
PR2986*

AC2993PM

Accessorio assiemaggio telaio
PR2987.2

*Frame assembling accessory
PR2987.2*

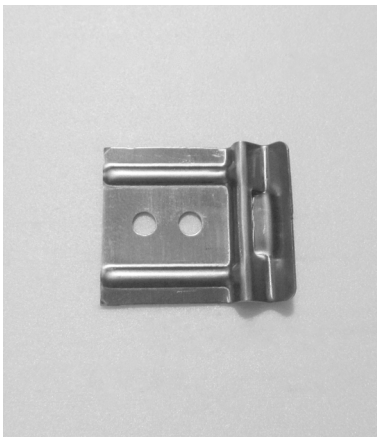
**AC2608**

Clips per fissaggio fermavetri
PR2629 - PR2638

*Clips for glazing bead
PR2629 - PR2638*

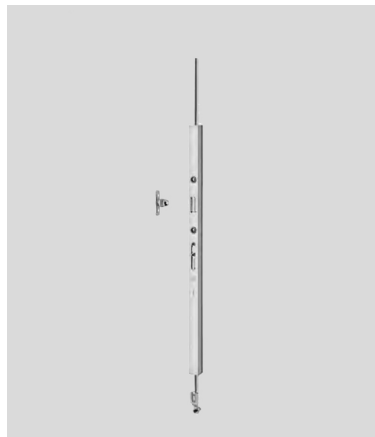
**AG2989.AB**

Kit prolunga aggiuntiva
cremonese

*Additional extension kit for
cremonese bolt set*

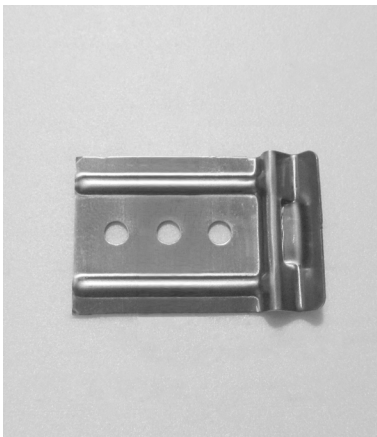
**AC 2608AR**

Clips per fissaggio fermavetri
PR2606 - PR2607 - PR2627

*Clips for securing
PR2606 - PR2607 - PR2627*

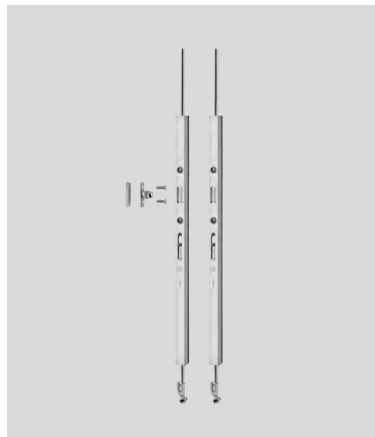
**AG2989.EF**

Kit prolunga aggiuntiva
cremonese per soluzione
coassiale

*Additional extension kit for
cremonese bolt set on coaxial leaf
solution*

**AC 2609AR**

Clips per fissaggio fermavetri
su profilo PR2954

*Clips for securing glazing beads
on PR2954 profile*

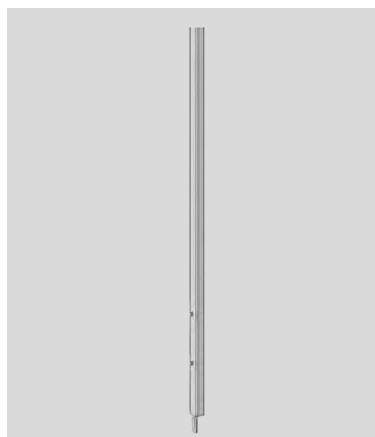
**AG2989 C**

Profilo di copertura aggiuntivo
cremonese
H 1000 mm

*Additional covering profile for
cremonese bolt
H 1000 mm*

**AG2992.AB**

Rostro aggiuntio

Additional hook bolt**CV5403 I**Rondella in acciaio inox/EPDM
vulcanizzato per viti di
assieme telaio inferiore
PR2983 - PR2984 con PR1195*Stainless steel/vulcanised EPDM
washer for assembly screws on
bottom-rail profil
PR2983 - PR2984 with PR1195***AG2992.EF**Rostro aggiuntio per
soluzione coassiale*Additional hook bolt on coaxial
leaf solution***CV1243.**Vite trilobata per boccola CV5012
TPS M4x8*Thread cutting machine screw
for bushing CV5012
TPS M4x8*CV1243 acciaio zincato | galvanized steel
CV1243I acciaio inox | stainless steel**CV5012.**Boccola per fermavetro in
alluminio
PA2606*Bushing for aluminium
glazing bead
PA2606*CV5012 acciaio zincato | galvanized steel
CV5012I acciaio inox | stainless steel

Tabella determinazione range dimensione ante per ordine kit movimentazione e tenuta

Table for sash range for the order of the handling and sealing kit

250 kg

altezza - height

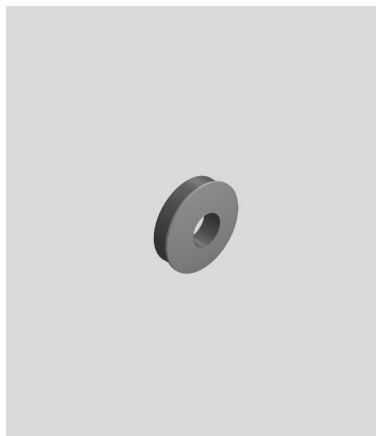
AG2986-7.xx 1135 1751 2101 2351 2701
 1750 2100 2350 2700 2908

larghezza 850 - 1925 A1 B1 C1 D1 E1
width

H maniglia - handle 396 996 996 996 996

Schema | Type A

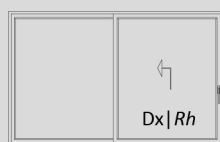

AG2986A.xx

Kit movimentazione e tenuta
1 anta apribile - anta dx

portata fino a 250 kg

1 leaf handling and sealing
kit - RH

load up to 250 kg

Schema | Type B

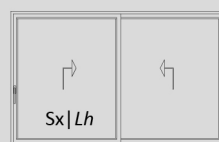

AG2987B.xx

Kit movimentazione e tenuta 2
ante apribili - 1^ anta sx

portata fino a 250 kg

2 leaf handling and sealing
kit - LH master

load up to 250 kg

Schema | Type A

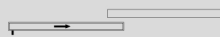
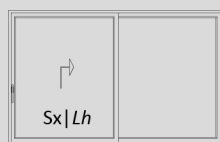

AG2987A.xx

Kit movimentazione e tenuta
1 anta apribile - anta sx

portata fino a 250 kg

1 leaf handling and sealing
kit - LH

load up to 250 kg

Schema | Type E

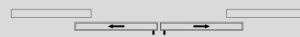
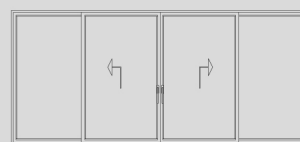

AG2986E.xx

Kit movimentazione e tenuta 2
ante apribili

portata fino a 250 kg

2 leaf handling and sealing kit

load up to 250 kg

Schema | Type B

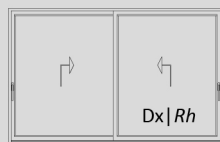

AG2986B.xx

Kit movimentazione e tenuta 2
ante apribili - 1^ anta dx

portata fino a 250 kg

2 leaf handling and sealing
kit - RH master

load up to 250 kg

Schema | Type F

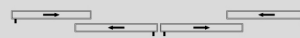

AG2986F.xx

Kit movimentazione e tenuta 4
ante apribili

portata fino a 250 kg

4 leaf handling and sealing kit

load up to 250 kg

Schema | Type S1

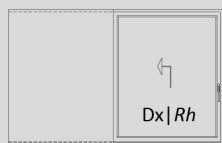
**AG2986S1.xx**

Kit movimentazione e tenuta
1 anta scomparsa - anta dx

portata fino a 250 kg

*1 concealed leaf handling and
sealing kit - RH*

load up to 250 kg

Schema | Type S1

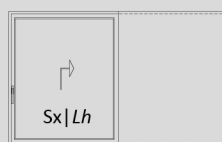
**AG2987S1.xx**

Kit movimentazione e tenuta
1 anta scomparsa - anta Sx

portata fino a 250 kg

*1 concealed leaf handling and
sealing kit - LH*

load up to 250 kg

Schema | Type T1

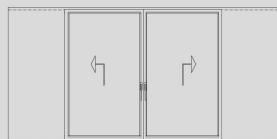
**AG2986T1.xx**

Kit movimentazione e tenuta
2 ante a scomparsa

portata fino a 250 kg

*2 concealed leaf handling and
sealing kit*

load up to 250 kg

Tabelle di determinazione range di utilizzo kit motorizzazione ante

Table for motorisation range kit selection

250 kg

	1751 2100	2101 2350	2351 2700	2701 2908
larghezza width	1135 - 1925	B1	C1	D1 E1
H sblocco - unlock	996	996	996	996

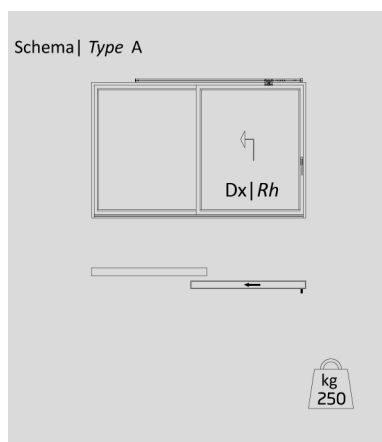

MG2986A.xx

Kit movimentazione e tenuta per ante motorizzate
1 anta apribile - anta dx

portata fino a 250 kg

*Motorised leaf handling and sealing kit
1 leaf - RH*

load up to 250 kg

MBSxxx

Motorizzazione scorrimento vedi pg. 2.3.5
Sliding motorisation see pg. 2.3.5

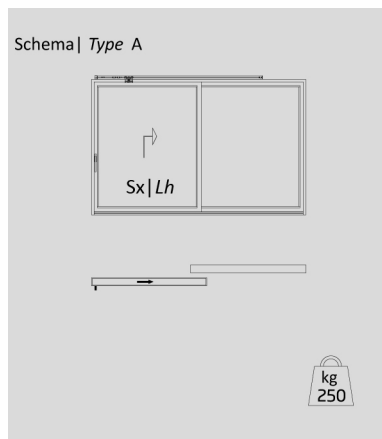

MG2987A.xx

Kit movimentazione e tenuta per ante motorizzate
1 anta apribile - anta sx

portata fino a 250 kg

*Motorised leaf handling and sealing kit
1 leaf - LH*

load up to 250 kg

MBSxxx

Motorizzazione scorrimento vedi pg. 2.3.5
Sliding motorisation see pg. 2.3.5

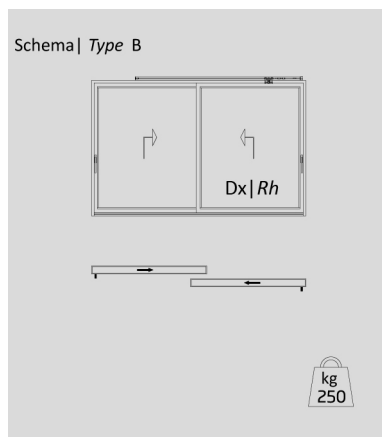

MG2986B.xx

Kit movimentazione e tenuta per ante motorizzate
2 ante apribili
1 anta motorizzata - dx

portata fino a 250 kg

*Motorised leaf handling and sealing kit
2 leaves
1 leaf motorised - RH*

load up to 250 kg

MBSxxx

Motorizzazione scorrimento vedi pg. 2.3.5
Sliding motorisation see pg. 2.3.5

Schema | Type B

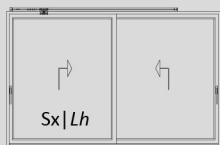
**MG2987B.xx**

Kit movimentazione e tenuta per ante motorizzate
2 ante apribili
1 anta motorizzata - sx

portata fino a 250 kg

*Motorised leaf handling and sealing kit
2 leafs
1 leaf motorised - LH*

load up to 250 kg

MBSxxx

Motorizzazione scorrimento vedi pg. 2.3.5
Sliding motorisation see pg. 2.3.5

Schema | Type E

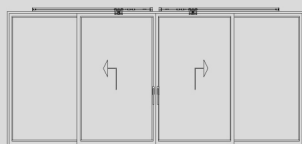
**MG2986E.xx**

Kit movimentazione e tenuta per ante motorizzate
2 ante apribili coassiali

portata fino a 250 kg

*Motorised leaf handling and sealing kit
2 coaxial leafs*

load up to 250 kg

MBXxxx

Motorizzazione scorrimento vedi pg. 2.3.5
Sliding motorisation see pg. 2.3.5

Schema | Type F

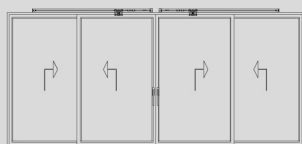
**MG2986F.xx**

Kit movimentazione e tenuta per ante motorizzate
4 ante apribili
2 ante coassiali motorizzate

portata fino a 250 kg

*Motorised leaf handling and sealing kit
4 leafs
2 coaxial leafs motorised*

load up to 250 kg

MBXxxx

Motorizzazione scorrimento vedi pg. 2.3.5
Sliding motorisation see pg. 2.3.5

Schema | Type S1

**MG2986S1.xx**

Kit movimentazione e tenuta per ante motorizzate
1 anta scomparsa - anta dx

portata fino a 250 kg

*Motorised leaf handling and sealing kit
1 concealed leaf - RH*

load up to 250 kg

MBSxxx

Motorizzazione scorrimento vedi pg. 2.3.5
Sliding motorisation see pg. 2.3.5

Schema | Type S1

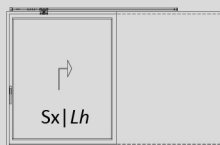
**MG2987S1.xx**

Kit movimentazione e tenuta per ante motorizzate
1 anta scomparsa - anta sx

portata fino a 250 kg

*Motorised leaf handling and sealing kit
1 concealed leaf - LH*

load up to 250 kg

MBSxxx

Motorizzazione scorrimento vedi pg. 2.3.5
Sliding motorisation see pg. 2.3.5

Schema | Type T1

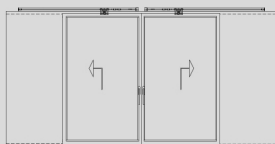
**MG2986T1.xx**

Kit movimentazione e tenuta per ante motorizzate
2 ante scomparsa coassiali

portata fino a 250 kg

*Motorised leaf handling and sealing kit
2 concealed coaxial leafs*

load up to 250 kg

MBXxxx

Motorizzazione scorrimento vedi pg. 2.3.5
Sliding motorisation see pg. 2.3.5

Kit motorizzazione scorrimento (da abbinare al kit movimentazione e tenuta per ante motorizzate MGxxxxxx.xx)

Sliding motorisation kit (to be combined with the handling and sealing kit for MGxxxxxx.xx motorised leaves)

SCHEMA TYPE	MOTORE MOTOR	LARGHEZZA ANTA SASH WIDTH	LUNGHEZZA MOTORE MOTOR LENGTH
A	MB S 140	1135 - 1430	2174
B	MB S 200	1431 - 1995	2774
S1	MB S 200	1431 - 1995	2774
E	MB X 150	1135 - 1500	3974
F	MB X 150	1135 - 1500	3974
T1	MB X 200	1501 - 1995	4974

Profili | Profiles

Prospetto | View
Vista interna | Internal view

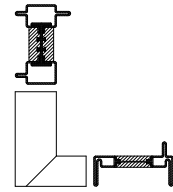
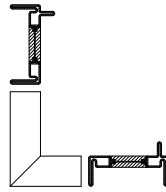

Schema | Type A

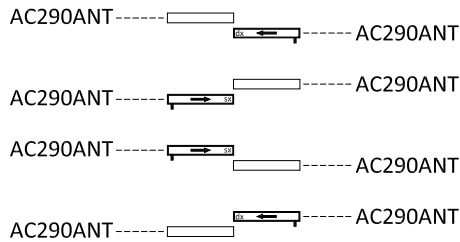
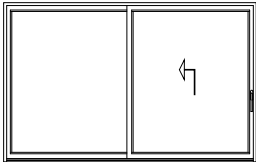

Schema | Type B

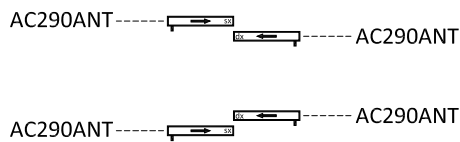
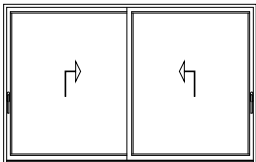

Schema | Type E

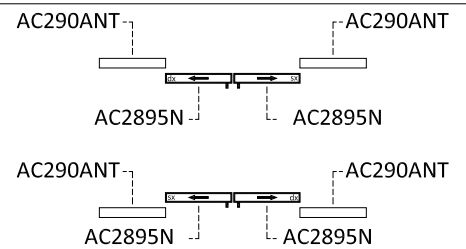
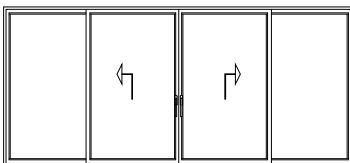

Schema | Type F

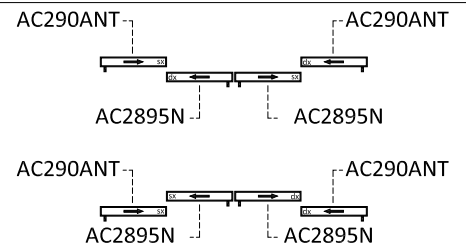
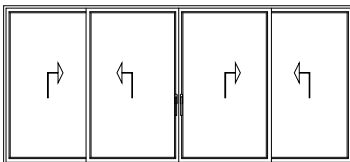

Schema | Type S1

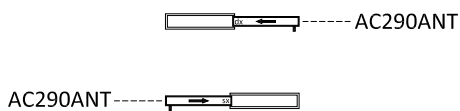
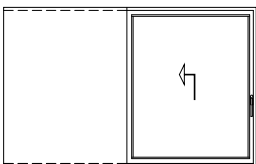

Schema | Type T1

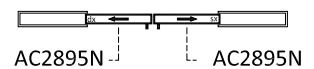
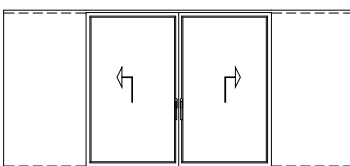

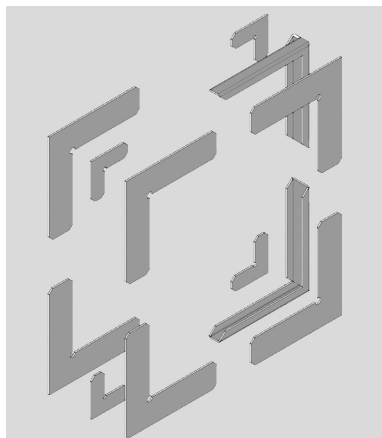
**AC290ANT**

Kit squadrette di giunzione angoli
per anta apribile o fissa
PR2975-PR2988
PR2975-PR2989

Acciaio inox

*Corner joint kit for openable or
fixed sash
PR2975-PR2988
PR2975-PR2989
Stainless steel*

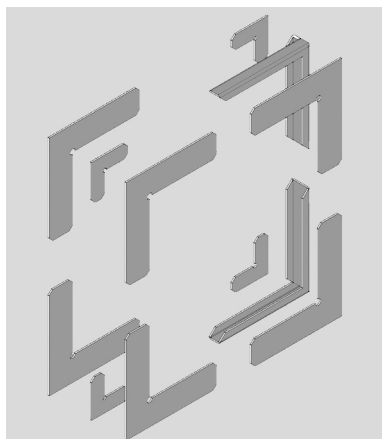
**AC2895N**

Kit squadrette di giunzione angoli
per anta apribile coassiale
PR2995N-PR2975-PR2989

Acciaio inox

*Corner joint kit for coaxial
openable sash
PR2995N-PR2975-PR2989
Stainless steel*

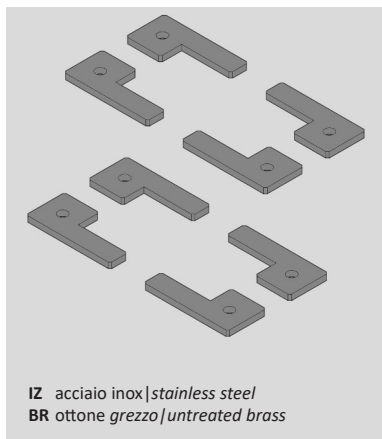
**AC298TES.xx**

Kit piastrelle di giunzione telaio
esterno
PR2986N-PR2986 (PR2987.2)

*Kit of external frame junction
plates
PR2986N-PR2986 (PR2987.2)*

IZ acciaio inox | stainless steel
BR ottone grezzo | untreated brass

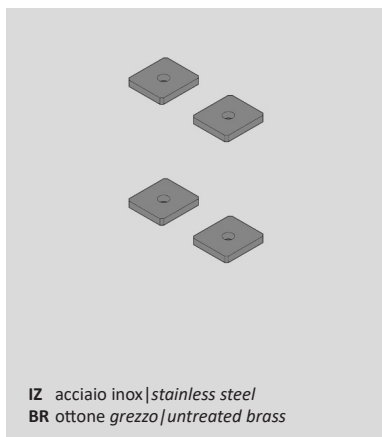
**AC298TSC.xx**

Kit piastrelle di giunzione telaio
esterno
PR1302S1-PR1320

*Kit of external frame junction
plates
PR1302S1-PR1320*

IZ acciaio inox | stainless steel
BR ottone grezzo | untreated brass

**ACV078.xx**

Maniglione singolo "VITRUVIO"
L | tonda | tronca
Ø18

Single "VITRUVIO" handle
L | round | cut
Ø18

SB acciaio inox | *stainless steel*
CZ acciaio corten | *corten steel*
BR ottone grezzo | *untreated brass*

**ACV078Y.xx**

Maniglione singolo "VITRUVIO"
con con foro chiave europea
L | tonda | tronca
Ø18

Single "VITRUVIO" handle
with European key hole
L | round | cut
Ø18

SB acciaio inox | *stainless steel*
CZ acciaio corten | *corten steel*
BR ottone grezzo | *untreated brass*

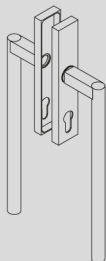
**ACV178Y.xx**

Maniglione doppio "VITRUVIO"
L | tonda | tronca
Ø18

Double "VITRUVIO" handle
L | round | cut
Ø18

SB acciaio inox | *stainless steel*
CZ acciaio corten | *corten steel*
BR ottone grezzo | *untreated brass*

**GE1011**

Guarnizione interna fermavetro
spessore 3-4 mm

*Internal gasket on 3-4 mm thick
glazing bead*

**GE2905S**

Guarnizione superiore ante

Top-rail gasket

**GE1142**

Guarnizione di tenuta labirinto

Labyrinth sealing gasket

**GE2907TT**

Guarnizione sotto vetro

Under glass gasket

**GE1305S**

Guarnizione laterale e inferiore
ante

*Sash uproghts an bottom rail
gasket*

**GP0095**

Guarnizione interna fermavetro
spessore 3 mm

*Internal glass gasket
3 mm thick*

**GE2606**

Guarnizione adesiva esterno
vetro
vedi pg. 5.1.1

*Adhesive weather strip outer
window
see pg. 5.1.2*

**GU1147**

Spazzolino per guida superiore
H=5 mm

*Brush on upper sliding track
H=5 mm*

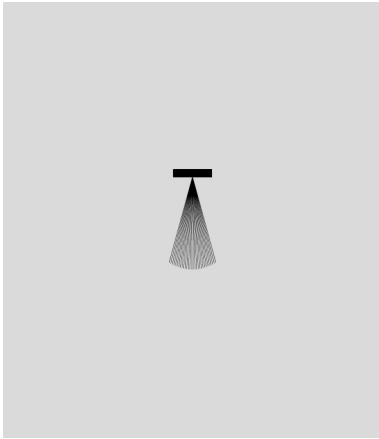
**GU1387**

Spazzolino per labirinto
H=13 mm

*Brush for labyrinth joint
H=13 mm*

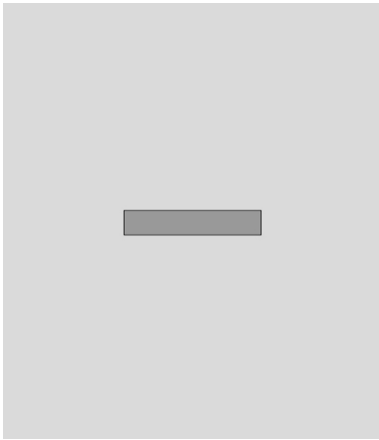
**GU2036**

Piattina adesiva morbida
per fondo giunto esterno vetro
12x4 mm

*Soft adhesive shim for
external window joint
12x4 mm*

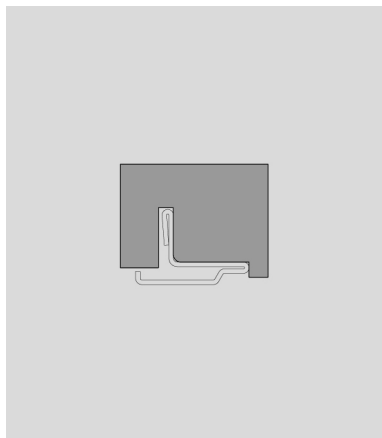
**AT2038**

Ganasce di taglio per
PR2638

*Cutting jaws for
PR2638*

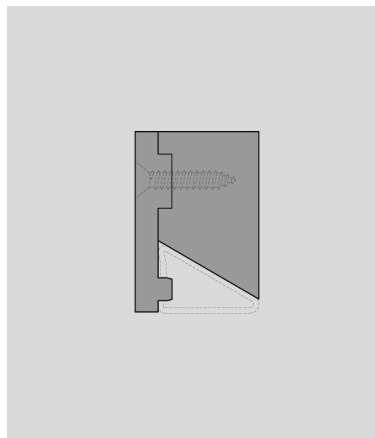
**AT2829**

Ganasce di taglio per
fermavetro PR2629

*Kit of cutting jaws
for glazin bead PR2629*

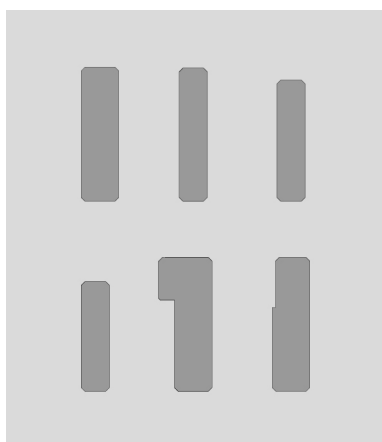
**AT2900**

Kit ganasce di taglio

Kit of cutting jaws for profiles

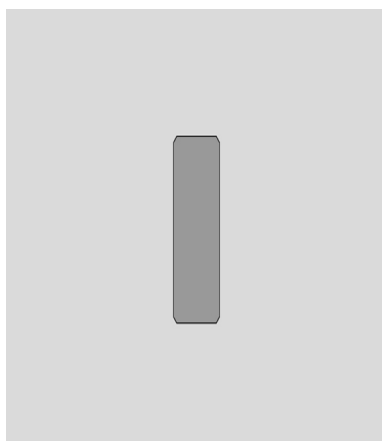
**AT2995N**

Ganascia di taglio per profilo
PR2995N

*Cutting jaws for
PR2995N profile*

**AT2828**

Maschera per esecuzione fori
fissaggio fermavetri

*Drill jig for glazing beads
securing*

**SA005/01**

Liquido neritore per brunitura
1 Kg

Burnishing liquid
1 Kg

SA005/10

Liquido neritore per brunitura
10 Kg

Burnishing liquid
10 Kg

**SA2031**

Liquido deumidificante vetri

Glass dehumidifying liquid

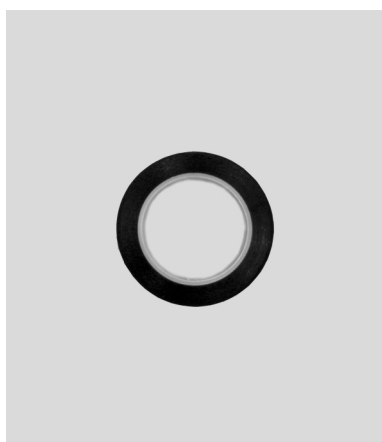
**SA1033**

Nastro adesivo protettivo per
verniciatura
33 mm

Adhesive tape for painting
33 mm

**SA2032**

Primer di adesione per profili
verniciati

*Adhesion primer for painted
profiles*

**SA2001**

Spray detergente antimpronta
per superfici in acciaio inox

*Anti-fingerprint detergent spray
for stainless steel surfaces*

**SA2033**

Liquido di adesione per
materiale plastico

Adhesion liquid for plastic

**SA2002**

Spray solvente per rimozione
collanti su superfici in acciaio
inox

*Solvent adhesive remover spray
for stainless steel surfaces*

**SA3001**

Acido per ossidazione corten

Oxidising acid for corten

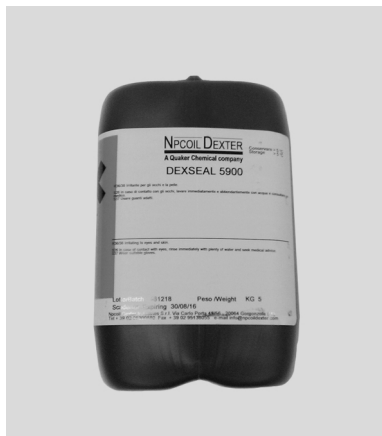
**SA3002**

Passivante per ossidazione corten
25 Kg

*Passivating agent for corten
25 Kg*

SA3002/5

Passivante per ossidazione corten
5 Kg

*Passivating agent for corten
5 Kg*

**SL0022**

Adesivo cianoacrilico per
tamponi in neoprene

*Cyanoacrylic adhesive for
neoprene pads*

**SA3003**

Cera d'api per finitura corten

Beeswax for Corten finishing

**SL0019**

Sigillante a freddo per giunzione
angoli e traversi

*Cold sealant for corner and
transom joints*

1 kg

**SL0021**

Silicone nero per guarnizioni

Black silicone for gaskets

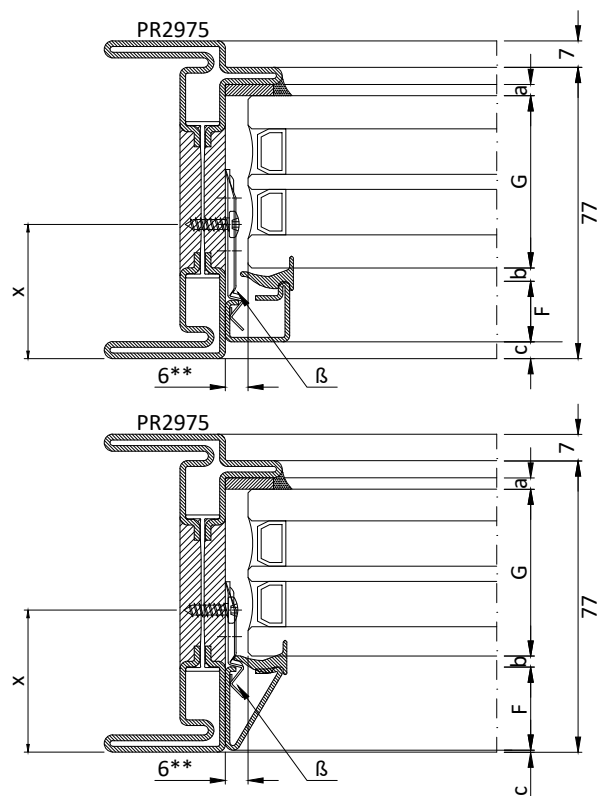

F	G	Guarnizioni - gasket				
fermavetro glazing beads	spessore vetro glass thickness	GU2036 3 mm + sigillatura + seal	GP0095 2 / 3 mm	asse fissaggio viti fermavetro glazing beads securing axis	rientro fermavetro glazing beads gap	clips fissaggio fermavetro glazing beads securing clips
codice code	mm	a	b	x	c	β
PR2606 	35 - 51	3	3	44 - 31	13 - 0	AC2608AR*
PR2607 	35 - 48			44 - 31	13 - 0	AC2608AR*
PR2627 	35 - 48			44 - 31	13 - 0	AC2608AR*
PR2629 	35 - 45			47 - 37	10 - 0	AC2608
PR2638 	35 - 48			54.5 - 41.5	13 - 0	AC2608

* fissare tramite il secondo foro della clip

* screw in the second hole of the clip

** 7 mm per PR2638

** 7 mm for PR2638

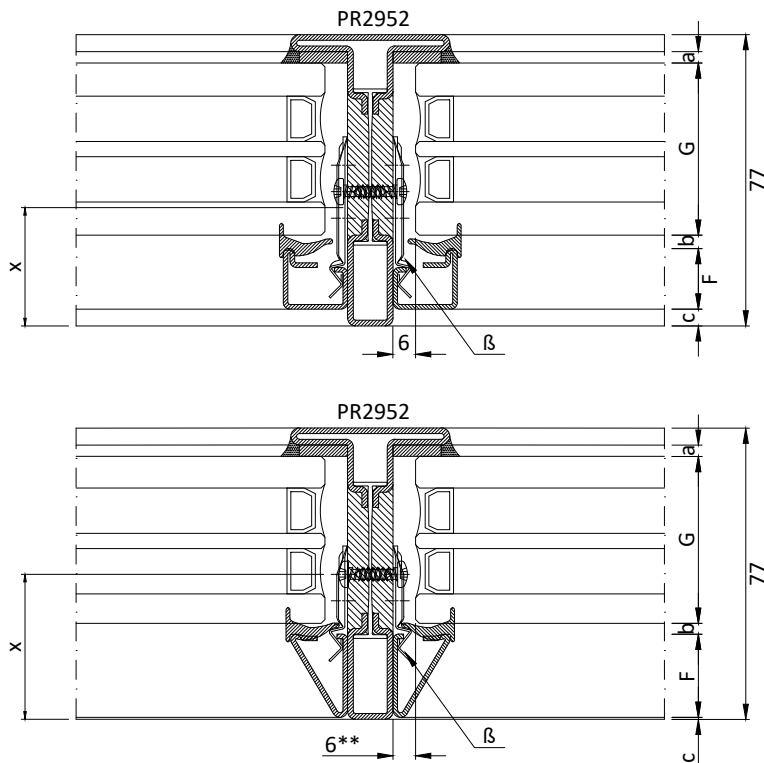

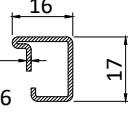
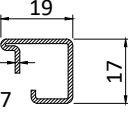
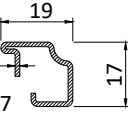
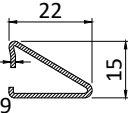
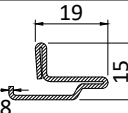
F	G	Guarnizioni - gasket		asse fissaggio viti fermavetro glazing beads securing axis	rientro fermavetro glazing beads gap	clips fissaggio fermavetro glazing beads securing clips
		GU2036 3 mm + sigillatura + seal	GP0095 2 / 3 mm			
 PR2606	35 - 51	3	3	44 - 31	13 - 0	AC2608AR*
 PR2607	35 - 48			44 - 31	13 - 0	AC2608AR*
 PR2627	35 - 48			44 - 31	13 - 0	AC2608AR*
 PR2629	35 - 45			47 - 37	10 - 0	AC2608
 PR2638	35 - 48			54.5 - 41.5	13 - 0	AC2608

* fissare tramite il secondo foro della clip
 * screw in the second hole of the clip
 ** 7 mm per PR2638
 ** 7 mm for PR2638

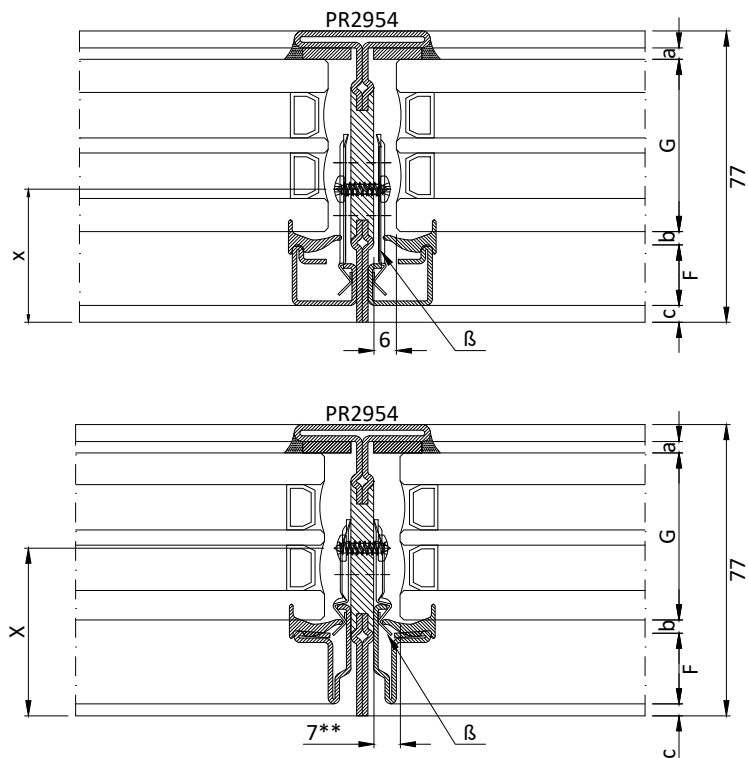

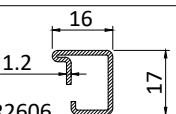
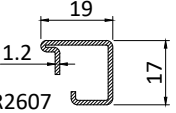
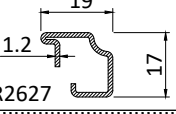
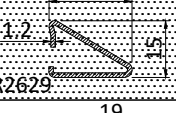
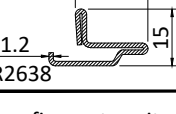

F	G	Guarnizioni - gasket				
fermavetro glazing beads	spessore vetro glass thickness	GU2036 3 mm + sigillatura + seal	GP0095 2 / 3 mm	asse fissaggio viti fermavetro glazing beads securing axis	rientro fermavetro glazing beads gap	boccole e viti fissaggio fermavetro Bushings and screws for fixing of glazing bead
codice code	mm	a	b	x	c	β
 PR2606	35 - 51!!			44 - 31	13 - 0	AC2609AR*
 PR2607	35 - 48	3	3	44 - 31	13 - 0	AC2609AR*
 PR2627	35 - 48			44 - 31	13 - 0	AC2609AR*
 PR2629	Non utilizzabile su PR2954 Cannot be used on PR2954					
 PR2638	35 - 48			54.5 - 41.5	13 - 0	AC2608

* fissare tramite il secondo foro della clip
 * screw in the second hole of the clip
 ** 7 mm per PR2638
 ** 7 mm for PR2638

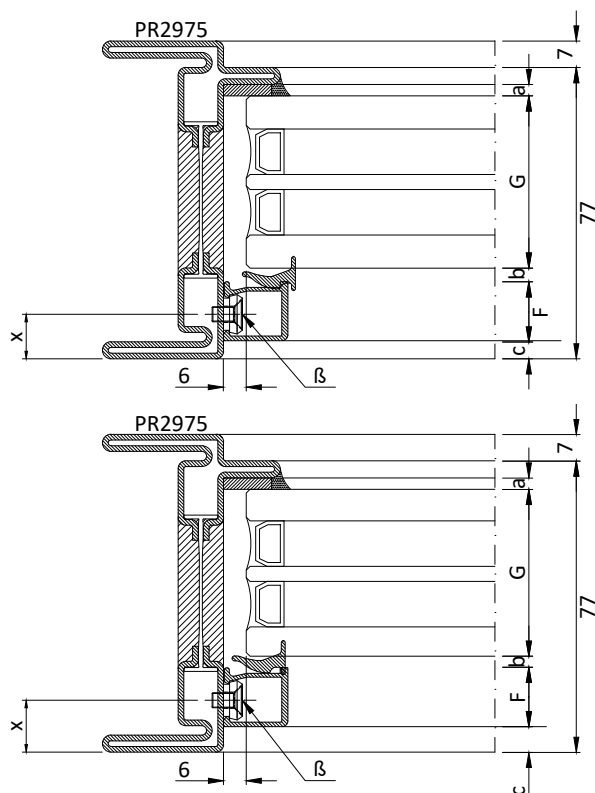
!! da 43 a 51 mm fissare tramite il secondo foro della clip con rondella di spessoramento da 1 mm
 !! from 43 to 51 mm fix through the second hole of the clip with shim washer of 1 mm

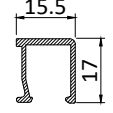
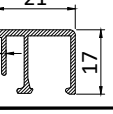

F	G	Guarnizioni - gasket		asse fissaggio viti fermavetro glazing beads securing axis	rientro fermavetro glazing beads gap	clips fissaggio fermavetro glazing beads securing clips
		GU2036 3 mm  + sigillatura + seal	GP0095 2 / 3 mm 			
fermavetro glazing beads	spessore vetro glass thickness					
codice code	mm					
PA2606 	40 - 51			18 - 7	11 - 0	CV1243(I) CV5012(I)
PA2607 	35 - 46	3	3	18 - 7	11 - 0	CV1243(I) CV5012(I)

Fissaggio fermavetri PR2606-PR2607-PR2627-PR2629-PR2638: clip AC2608/AC2608AR/AC2609AR con vite TC 3.5 x 9.5 (non fornite)
 Glazing beads fixing PR2606-PR2607-PR2627-PR2629-PR2638: clip AC2608/AC2608AR/AC2609AR with screw TC 3.5 x 9.5 (not included)

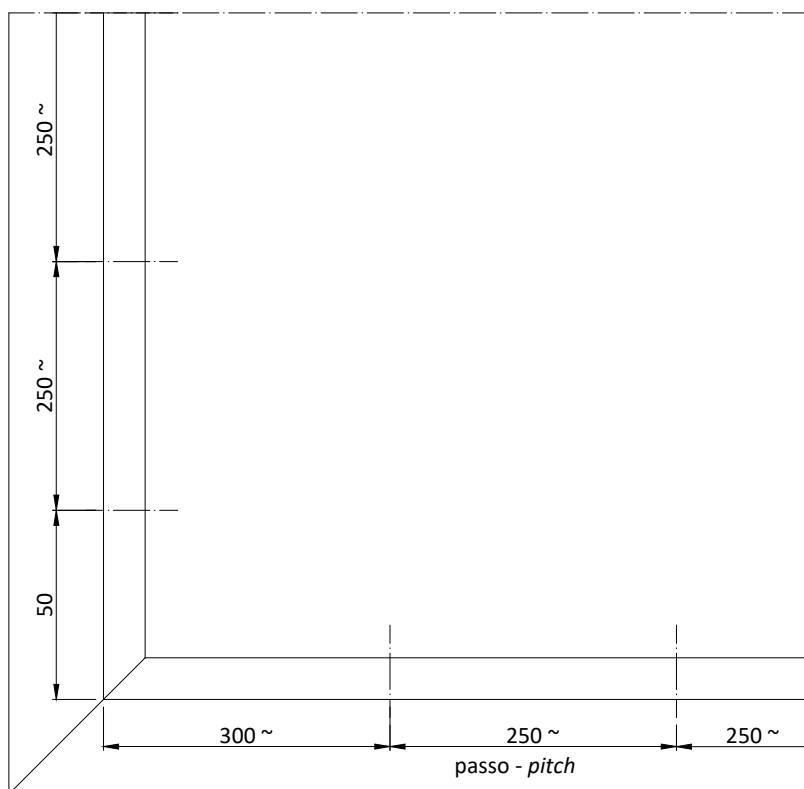
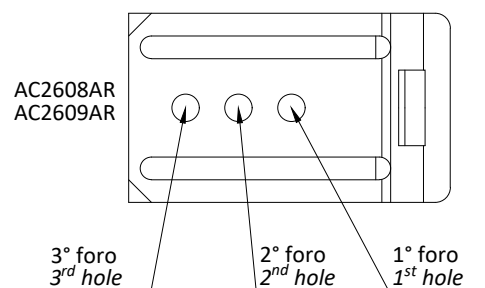
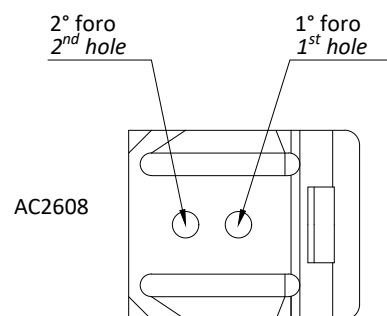
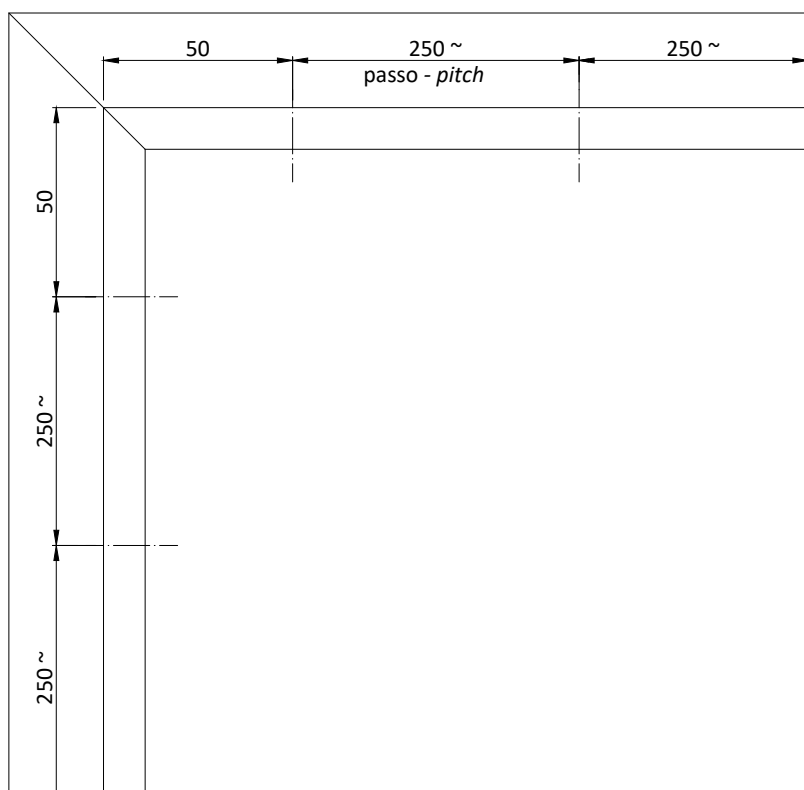

Passo clips fissaggio fermavetri
 Clip pitch for glazing beads securing

Fissaggio fermavetri PA2606-PA2607: vite CV1243(I) TPS 4.2x13 e boccola CV5012(I)
Glazing bead fixing PA2606-PA2607: screw CV1243(I) TPS 4.2x13 and bushing CV5012(I)

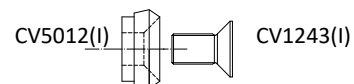
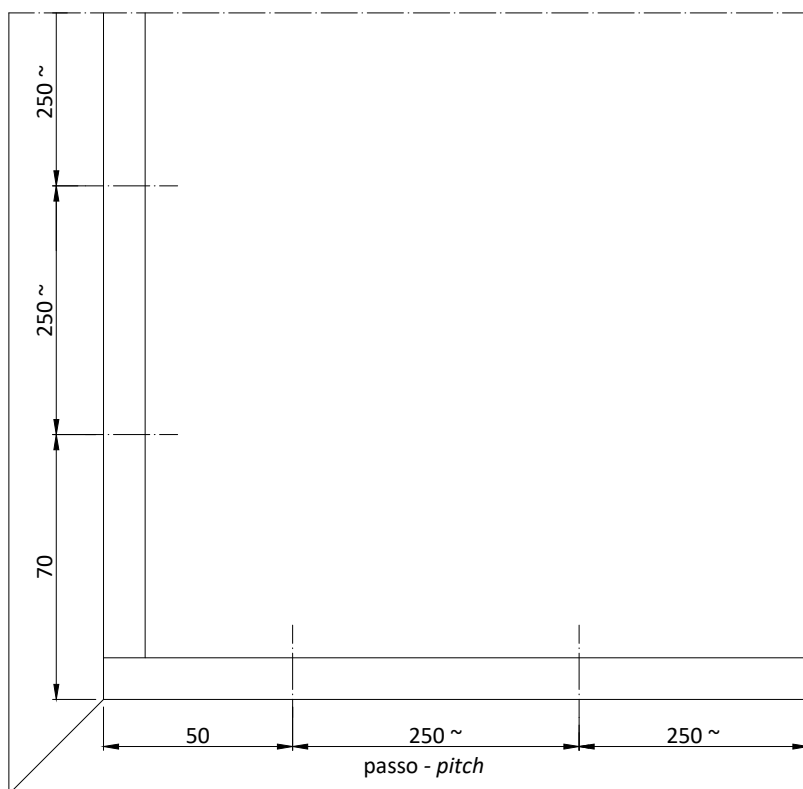
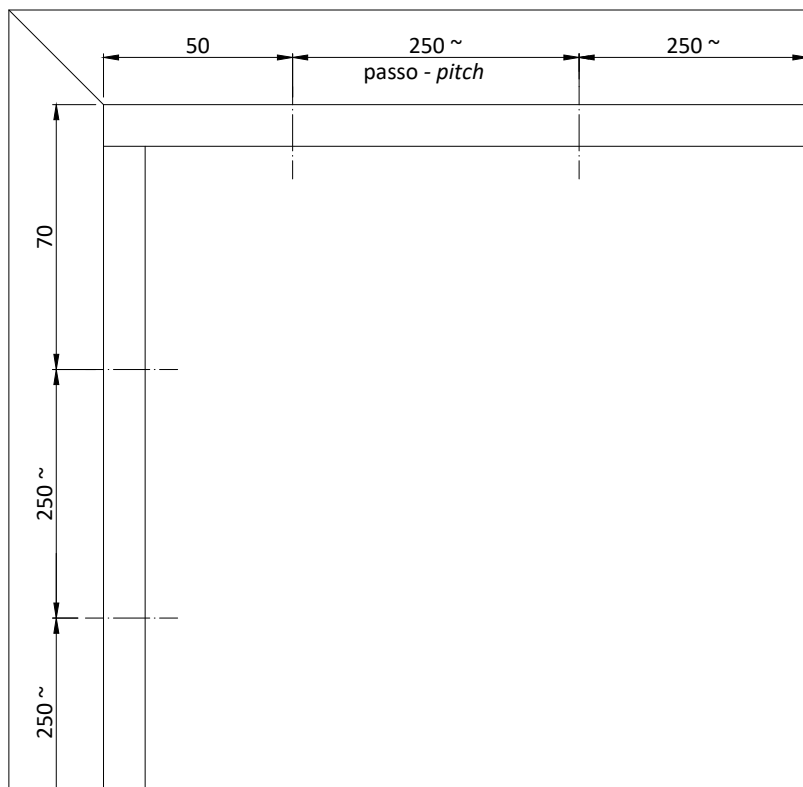

Passo vite e boccola fissaggio fermavetri
Screw and bushing pitch for glazing beads fixing

Schema | Type A

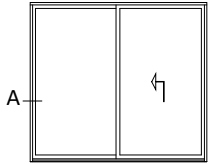

Schema | Type B

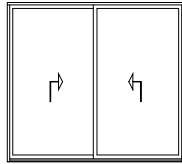

Schema | Type E

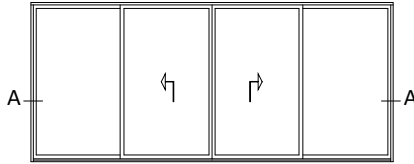

Schema | Type F

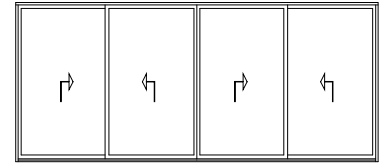

Schema | Type S1

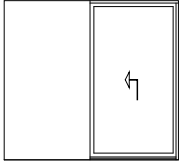

Schema | Type T1

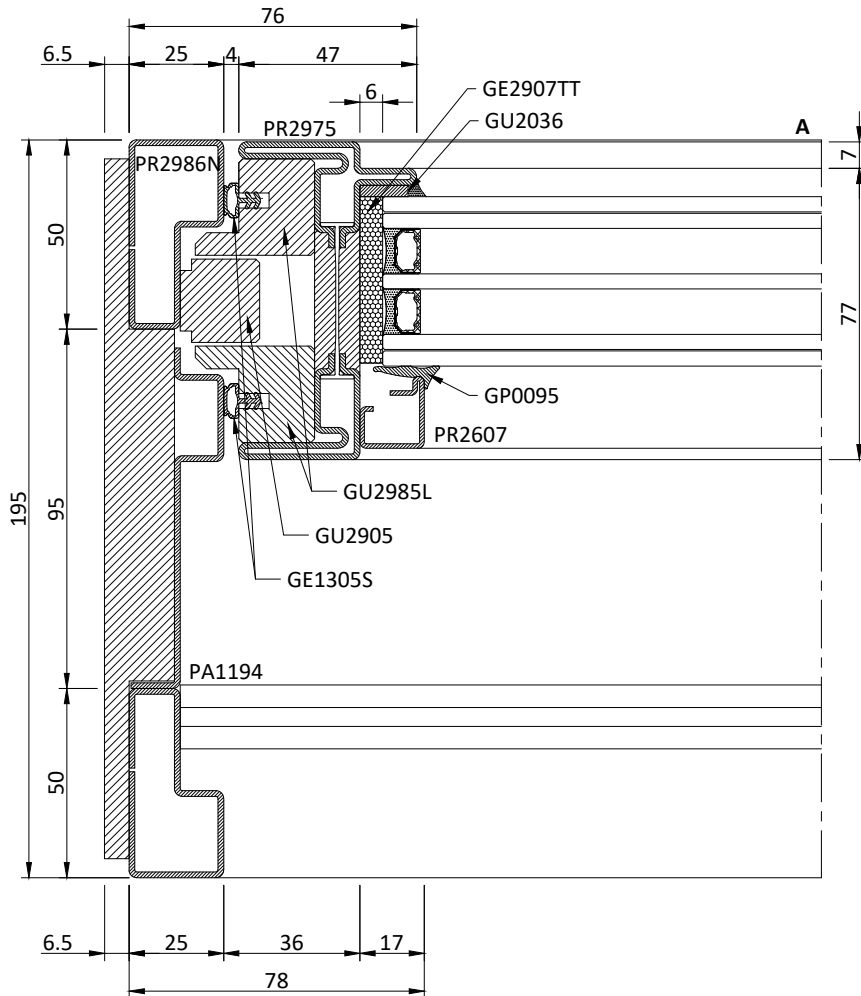
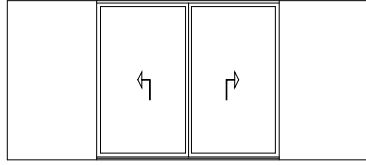

Schema | Type A

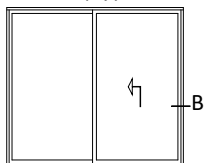

Schema | Type B

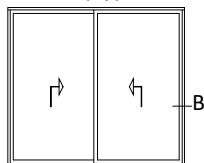

Schema | Type E

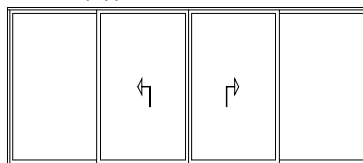

Schema | Type F

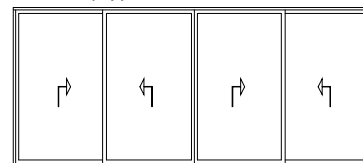

Schema | Type S1

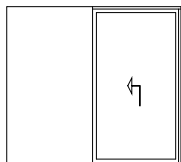

Schema | Type T1

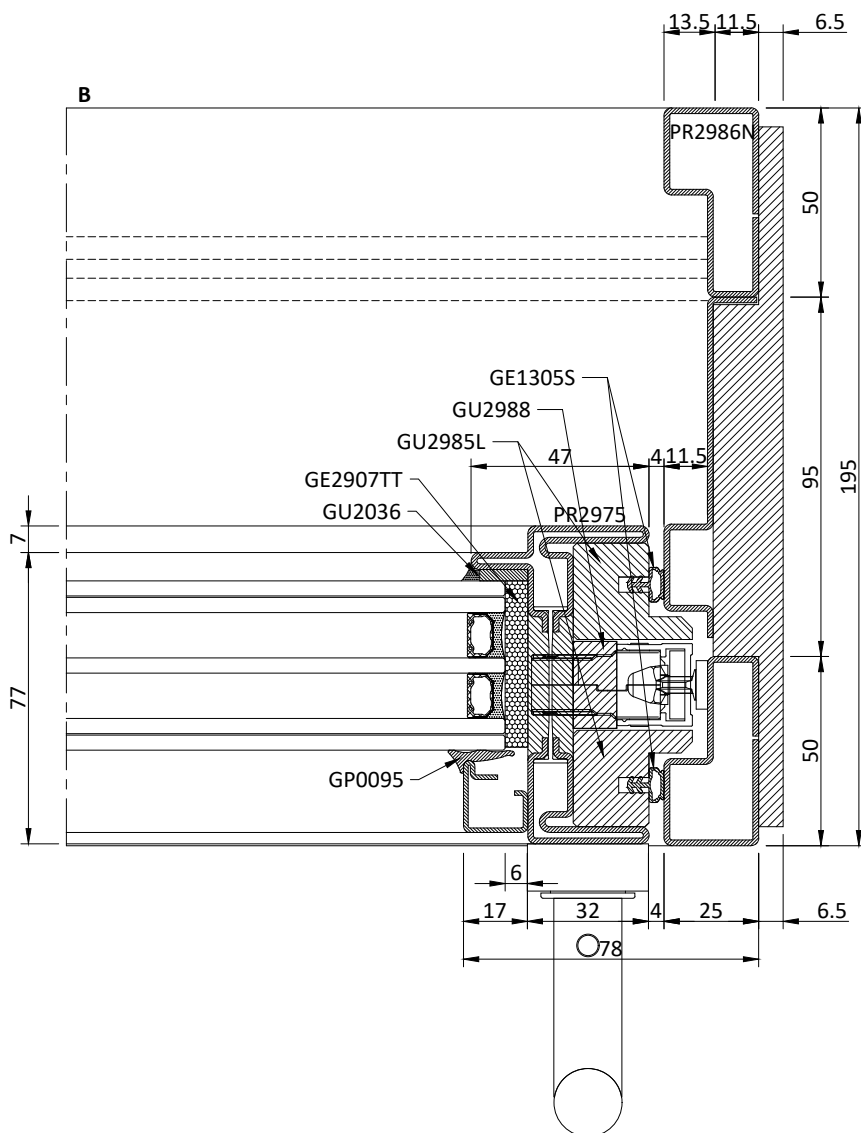
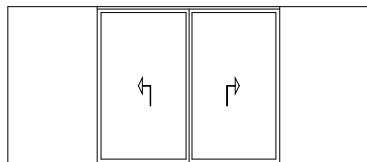

Schema | Type A

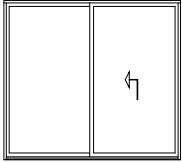

Schema | Type B

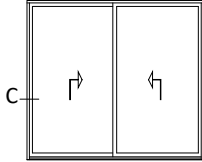

Schema | Type E

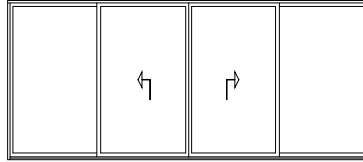

Schema | Type F

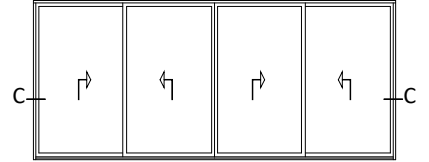

Schema | Type S1

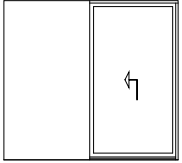

Schema | Type T1

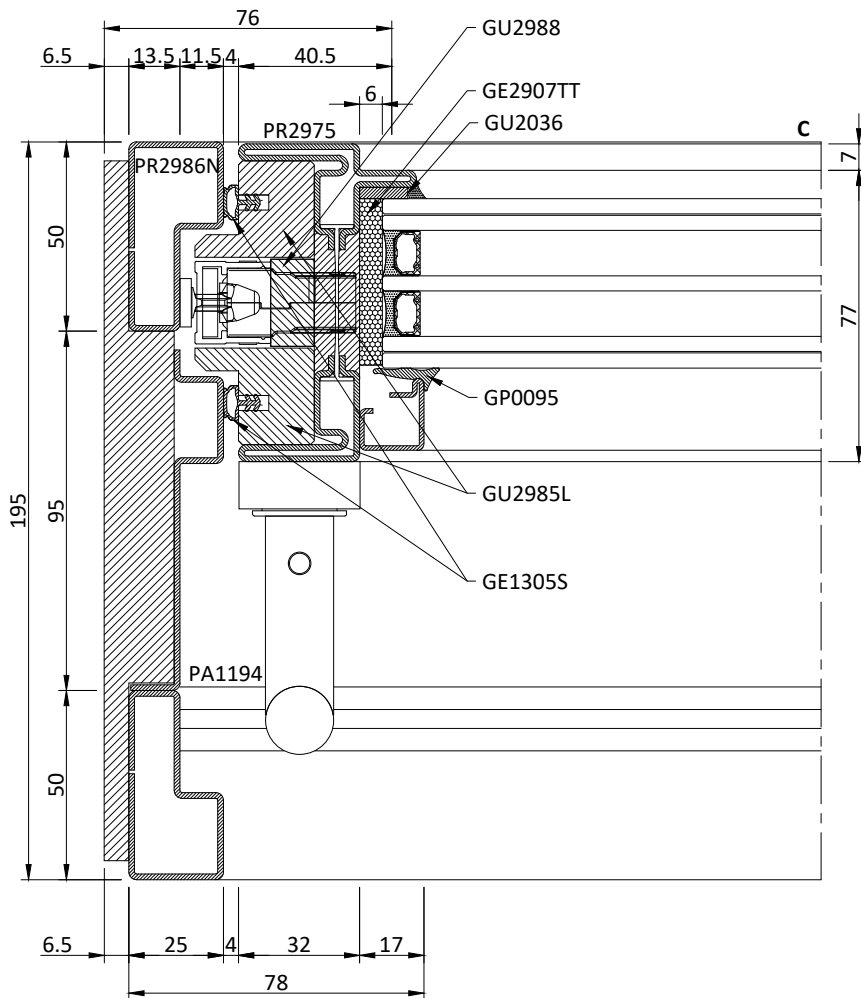
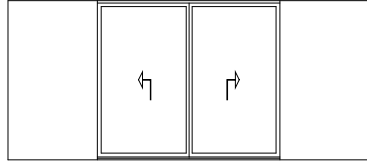

Schema | Type A

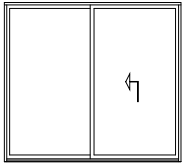

Schema | Type B

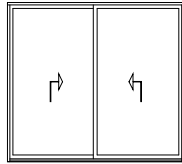

Schema | Type E

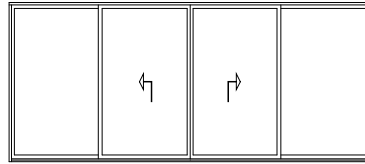

Schema | Type F

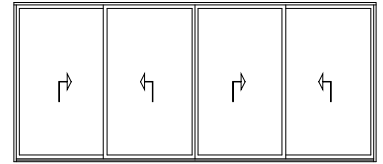

Schema | Type S1

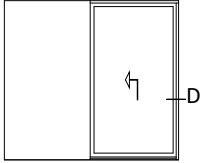

Schema | Type T1

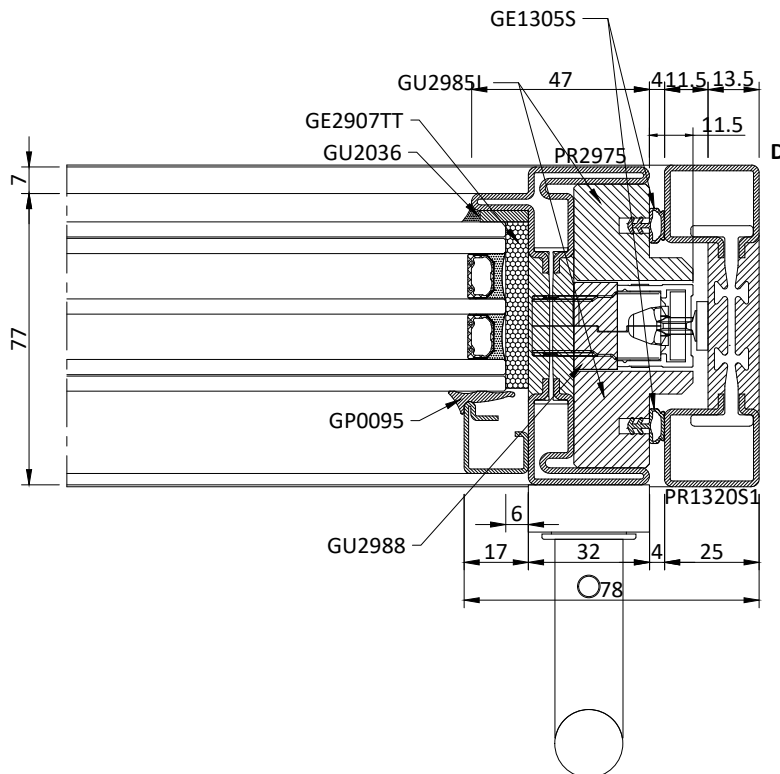
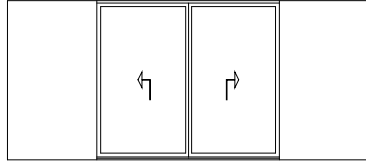

Schema | Type A

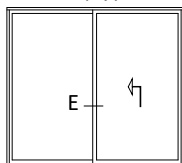

Schema | Type B

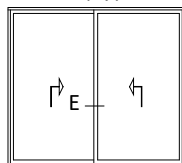

Schema | Type E

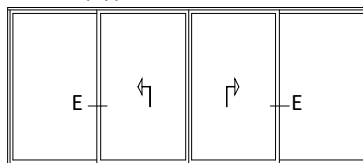

Schema | Type F

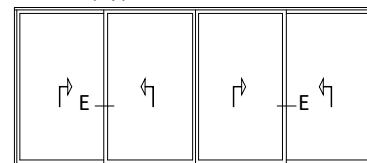

Schema | Type S1

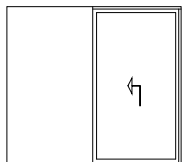

Schema | Type T1

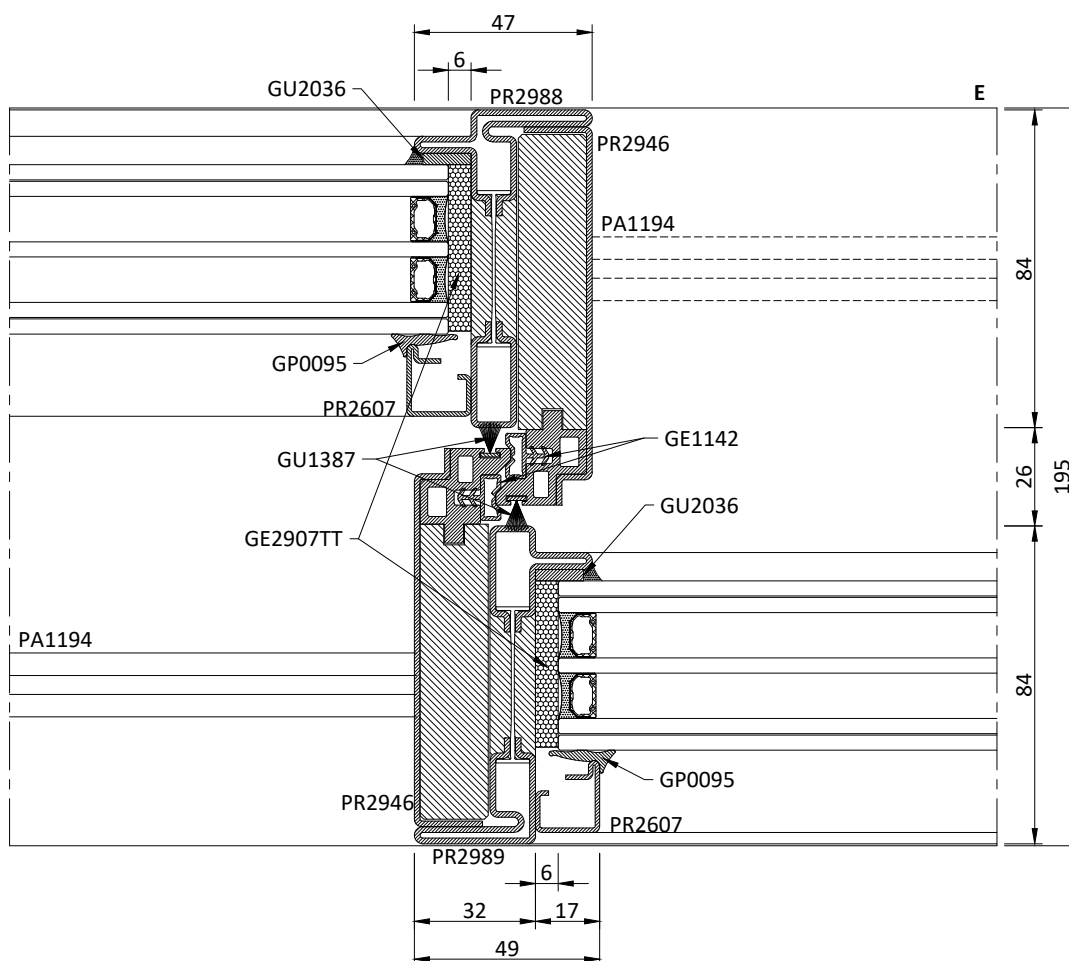
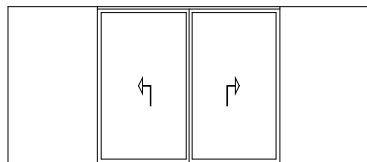

Schema | Type A

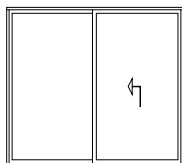

Schema | Type B

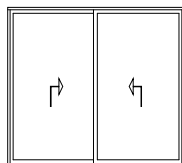

Schema | Type E

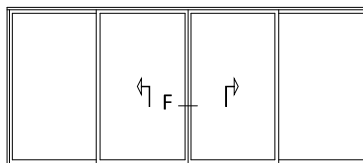

Schema | Type F

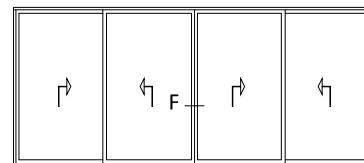

Schema | Type S1

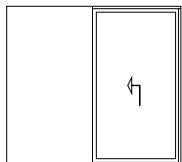

Schema | Type T1

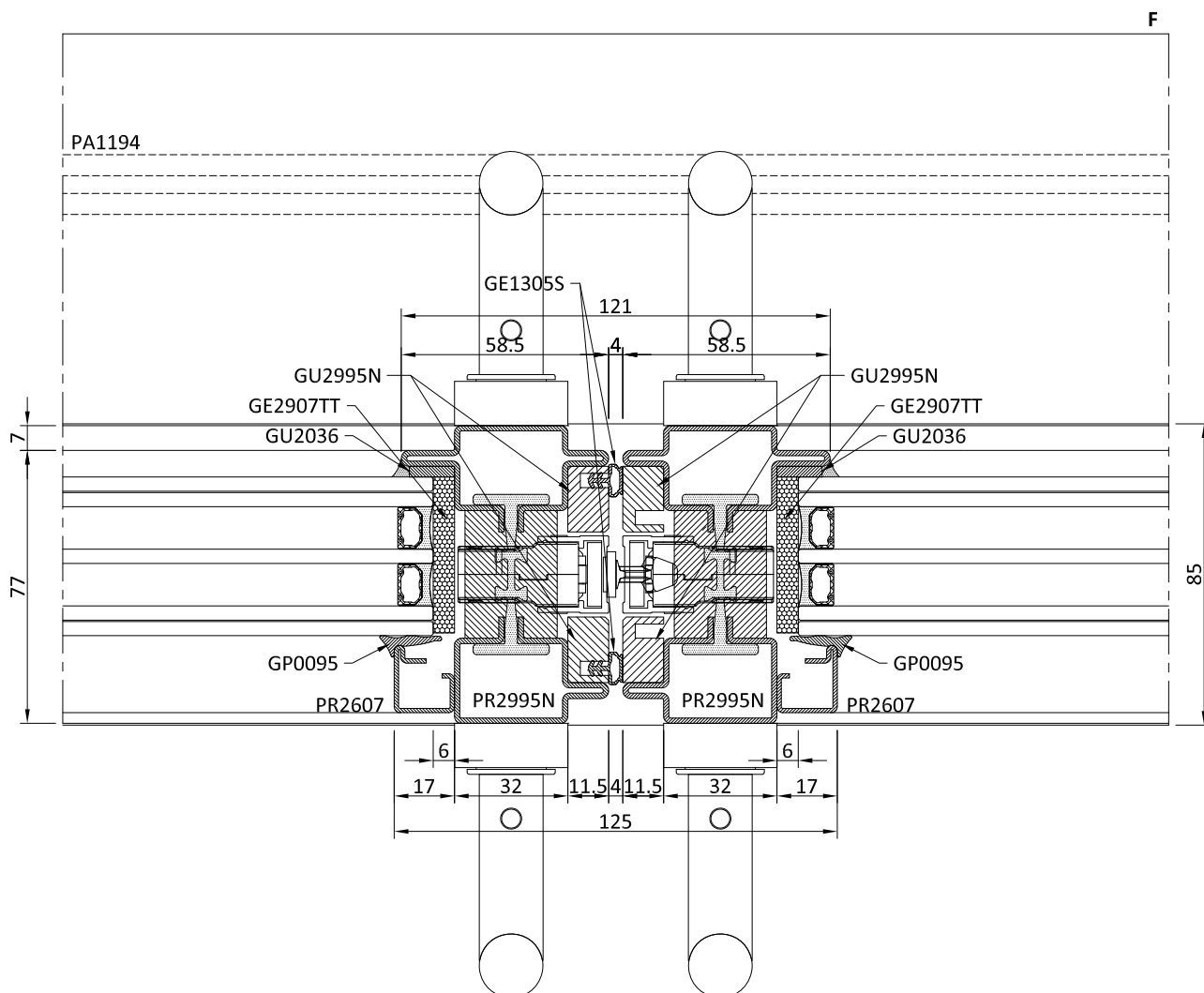
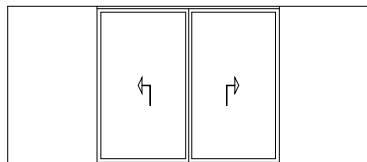

Schema | Type A

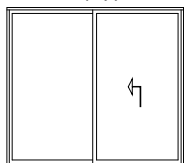

Schema | Type B

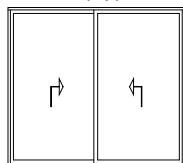

Schema | Type E

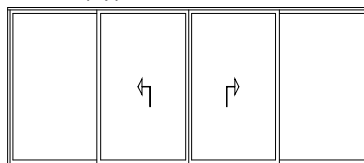

Schema | Type F

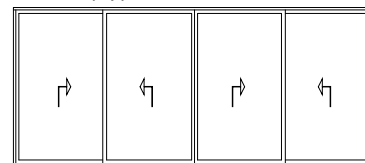

Schema | Type S1

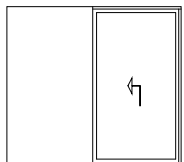

Schema | Type T1

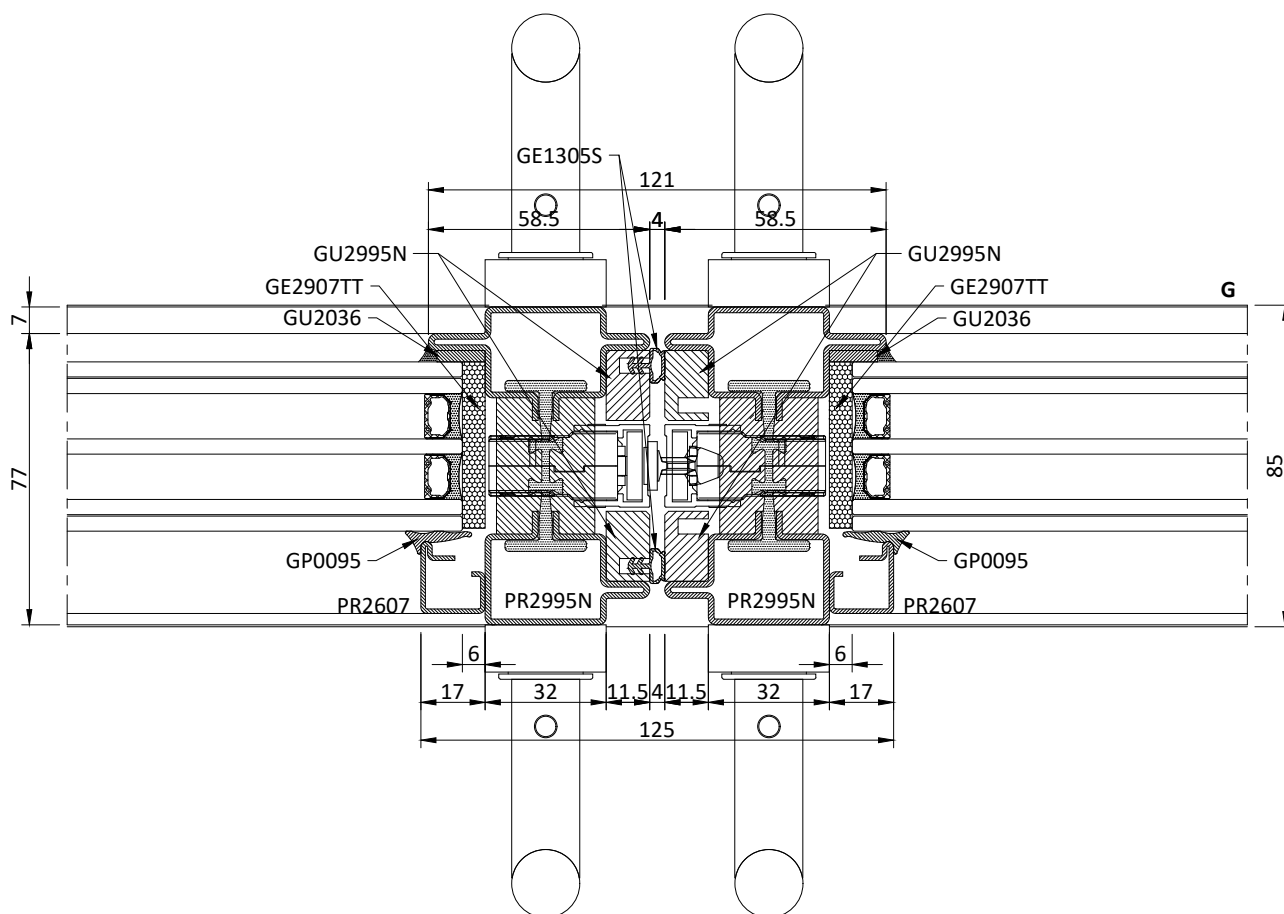
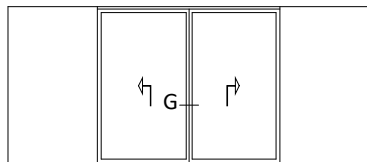

Schema | Type A

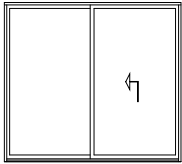

Schema | Type B

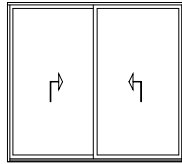

Schema | Type E

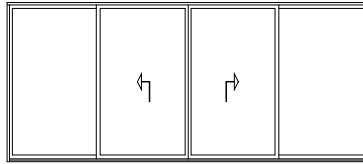

Schema | Type F

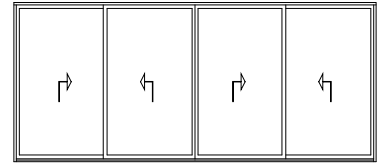

Schema | Type S1

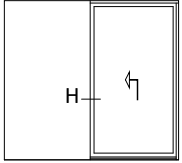

Schema | Type T1

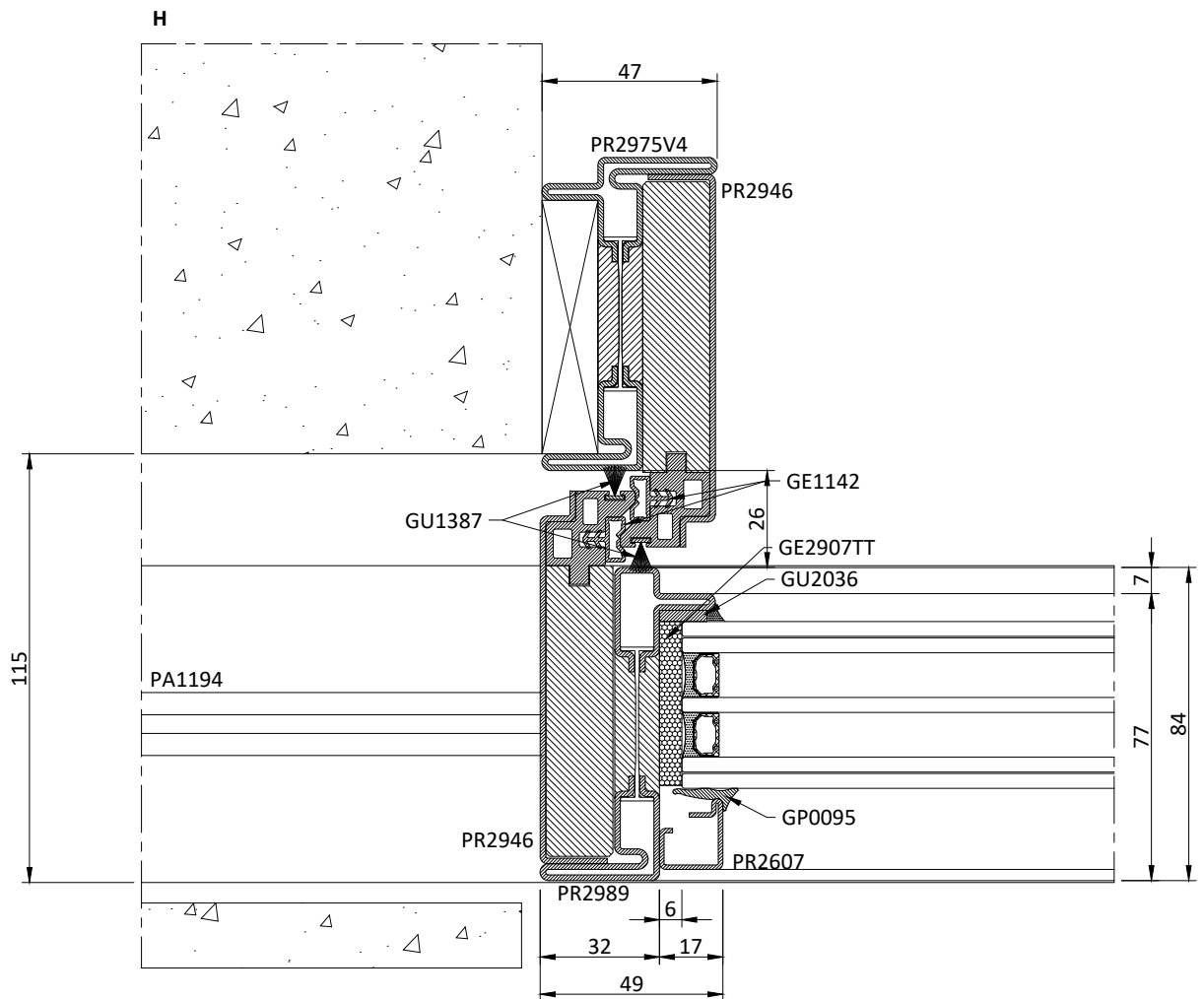
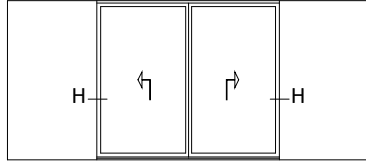

Schema | Type A

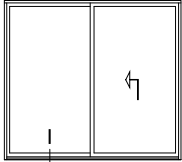

Schema | Type B

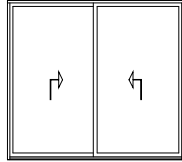

Schema | Type E

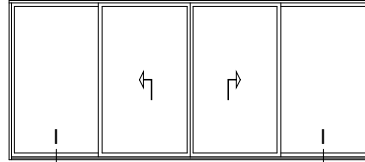

Schema | Type F

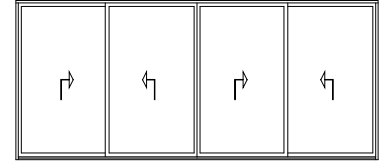

Schema | Type S1

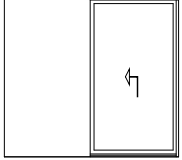

Schema | Type T1

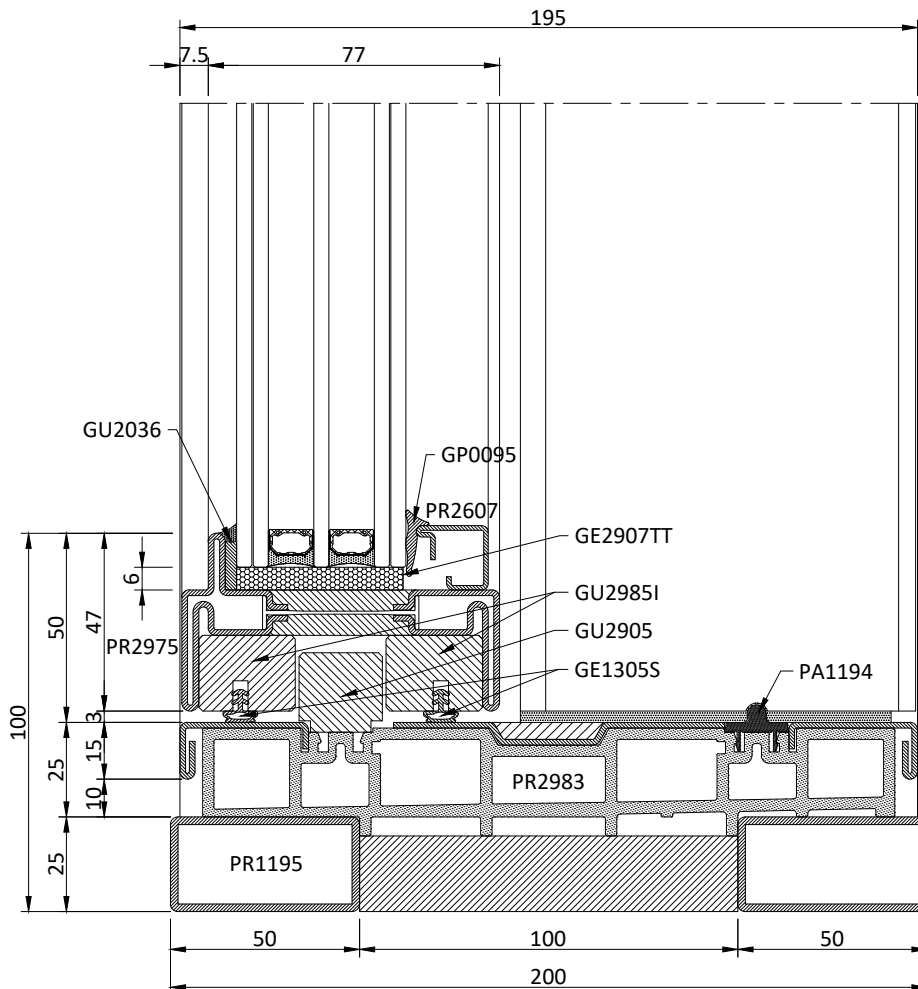
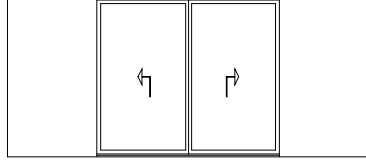

Schema | Type A

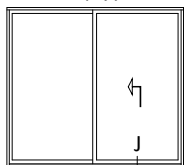

Schema | Type B

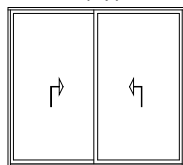

Schema | Type E

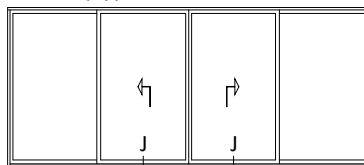

Schema | Type F

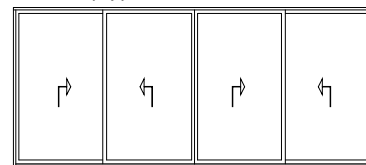

Schema | Type S1

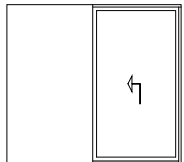

Schema | Type T1

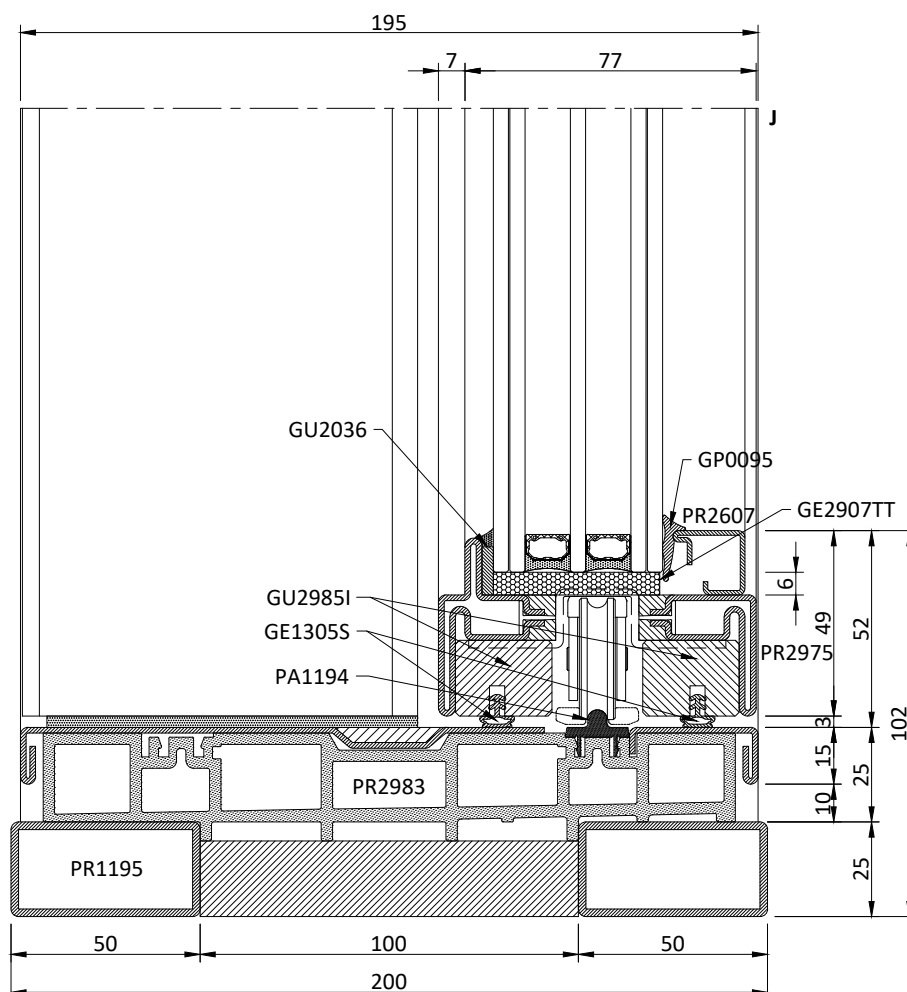
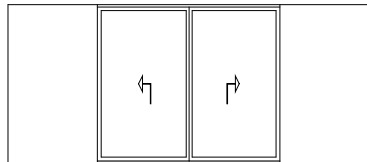

Schema | Type A

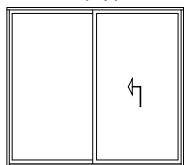

Schema | Type B

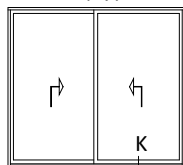

Schema | Type E

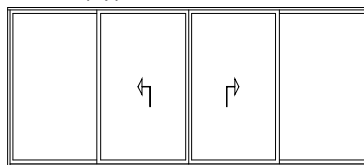

Schema | Type F

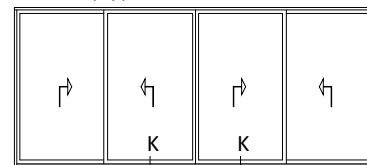

Schema | Type S1

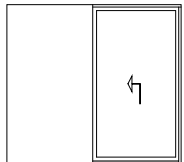

Schema | Type T1

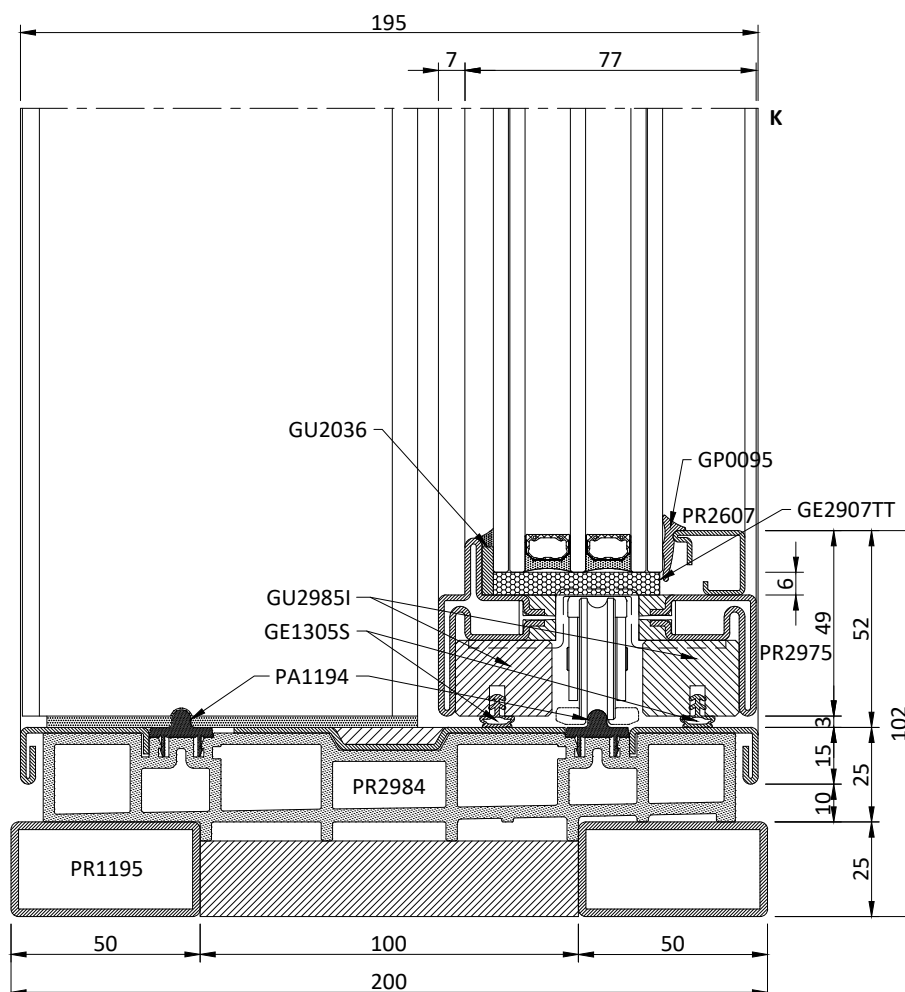
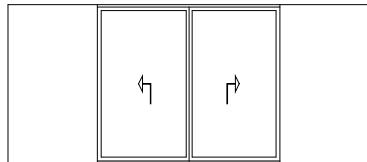

Schema | Type A

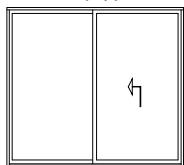

Schema | Type B

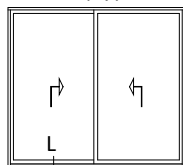

Schema | Type E

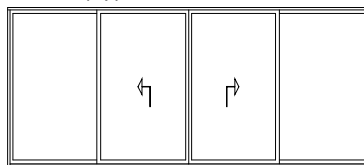

Schema | Type F

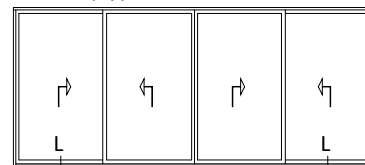

Schema | Type S1

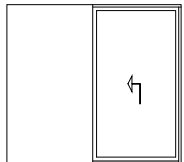

Schema | Type T1

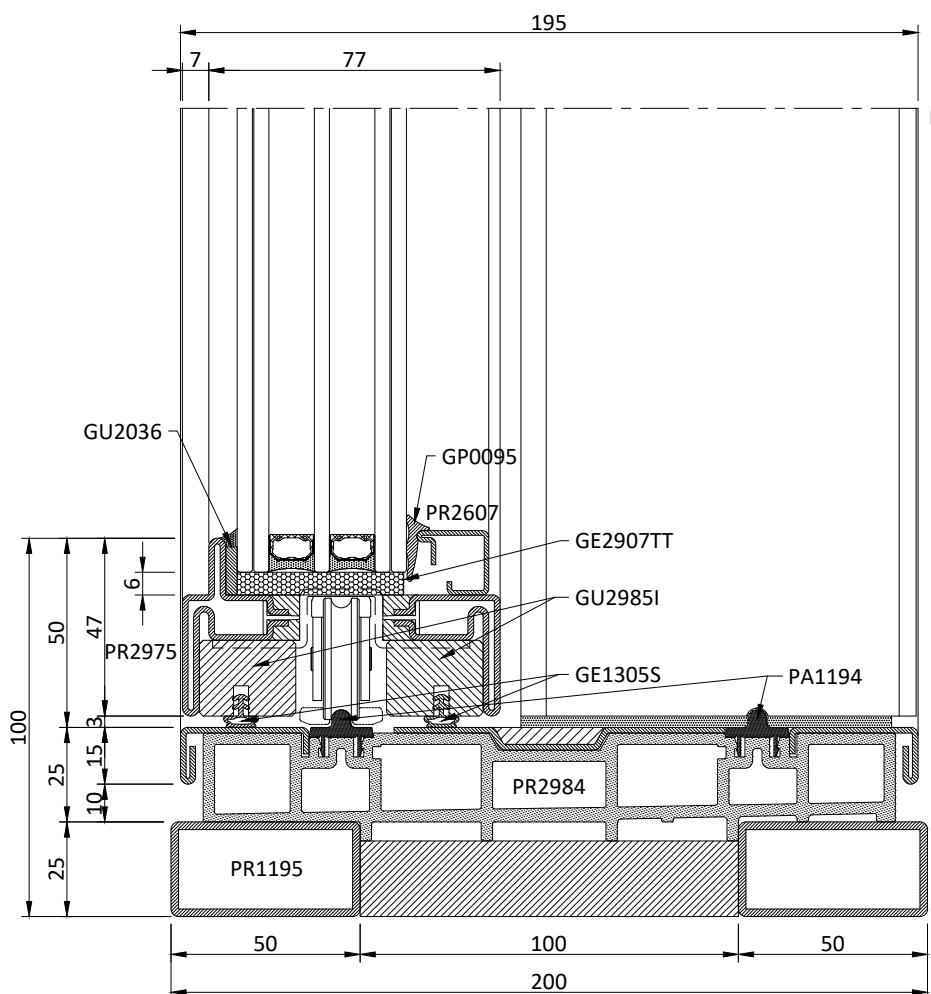
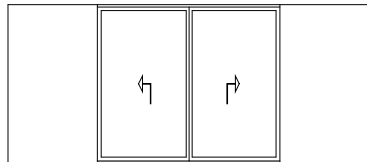

Schema | Type A

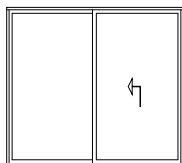

Schema | Type B

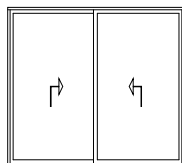

Schema | Type E

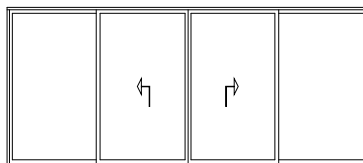

Schema | Type F

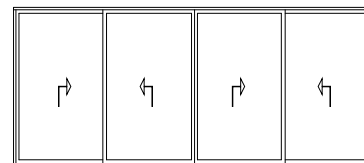

Schema | Type S1

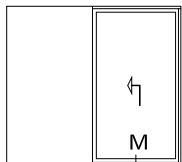

Schema | Type T1

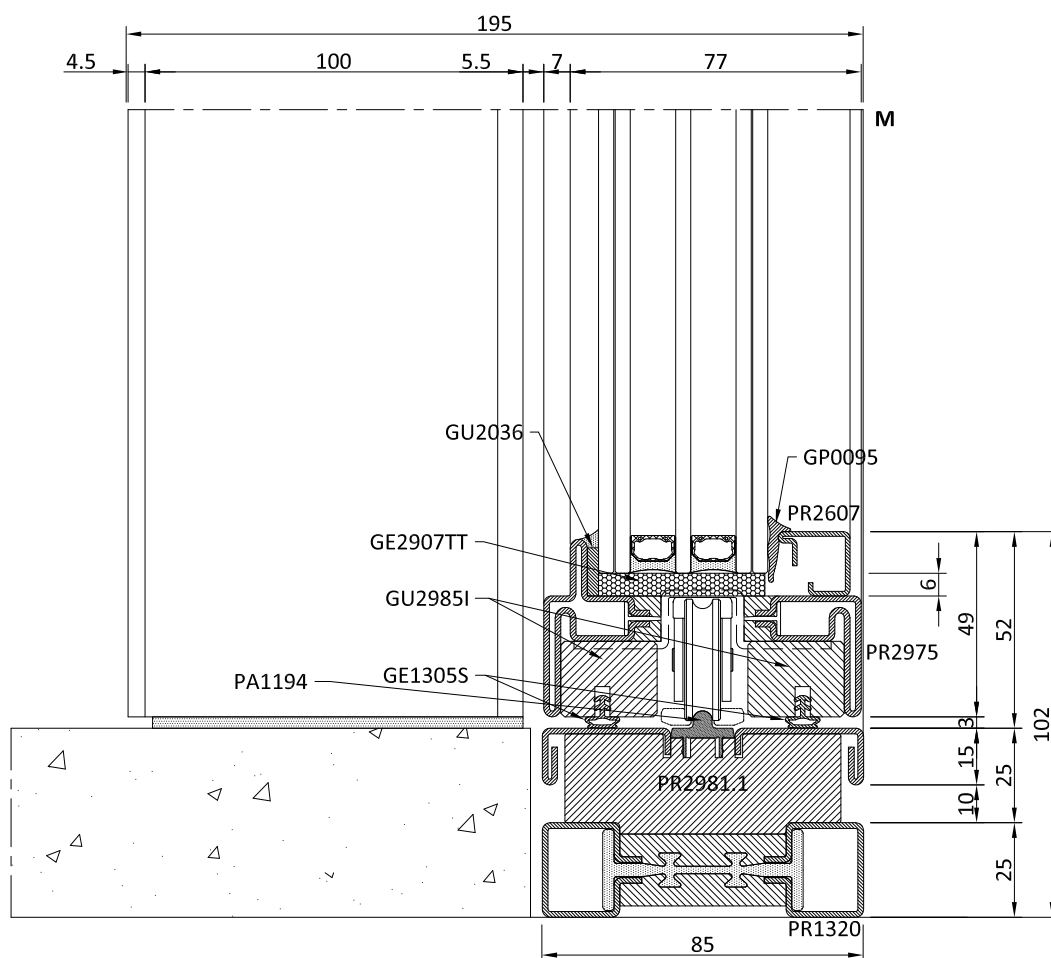
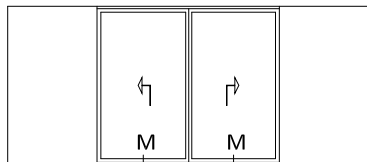

Schema | Type A

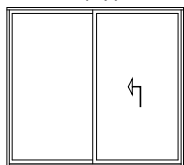

Schema | Type B

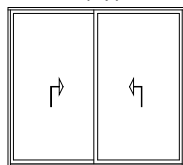

Schema | Type E

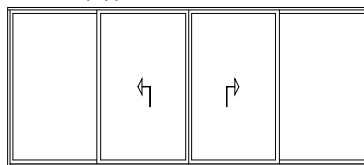

Schema | Type F

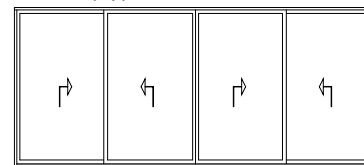

Schema | Type S1

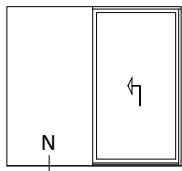

Schema | Type T1

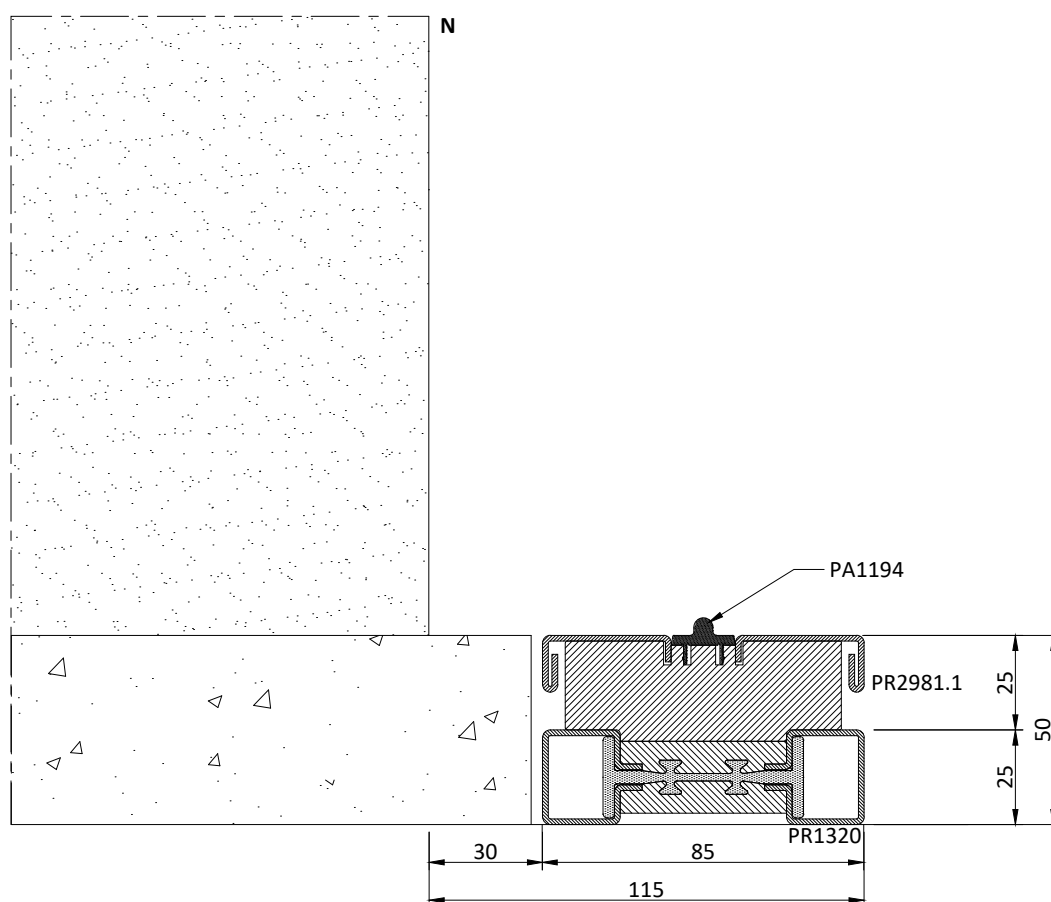
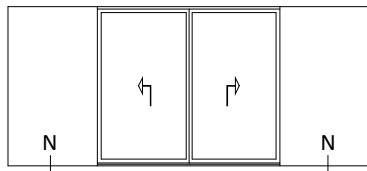

Schema | Type A

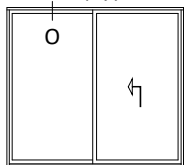

Schema | Type B

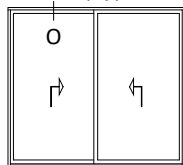

Schema | Type E

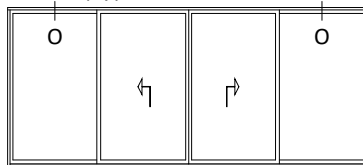

Schema | Type F

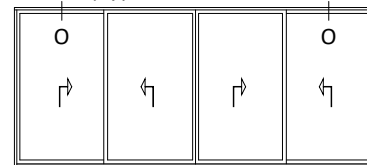

Schema | Type S1

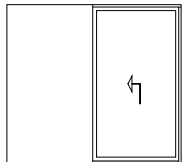

Schema | Type T1

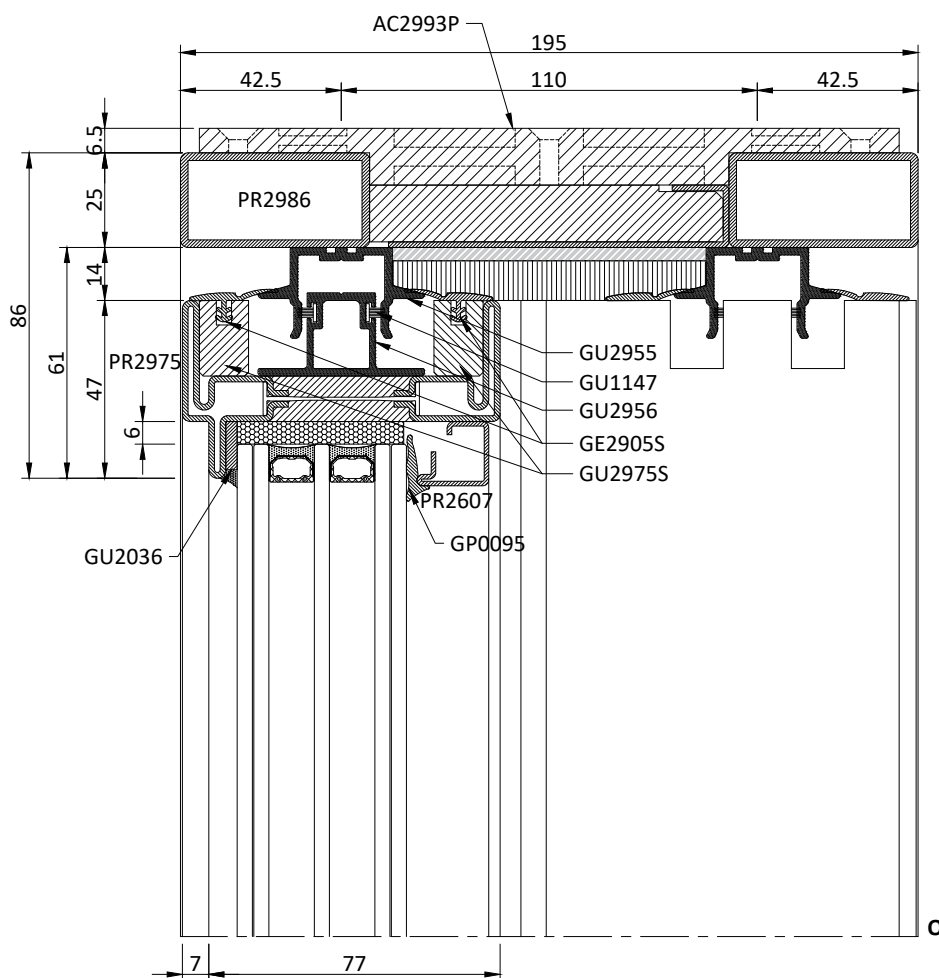
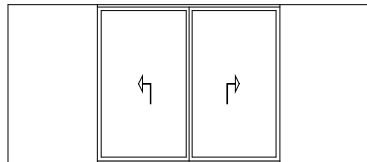

Schema | Type A

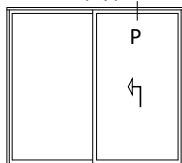

Schema | Type B

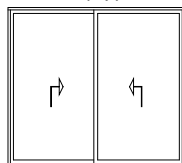

Schema | Type E

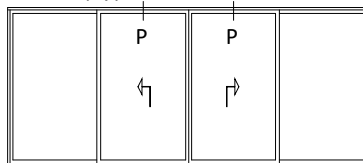

Schema | Type F

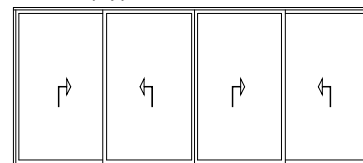

Schema | Type S1

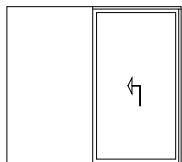

Schema | Type T1

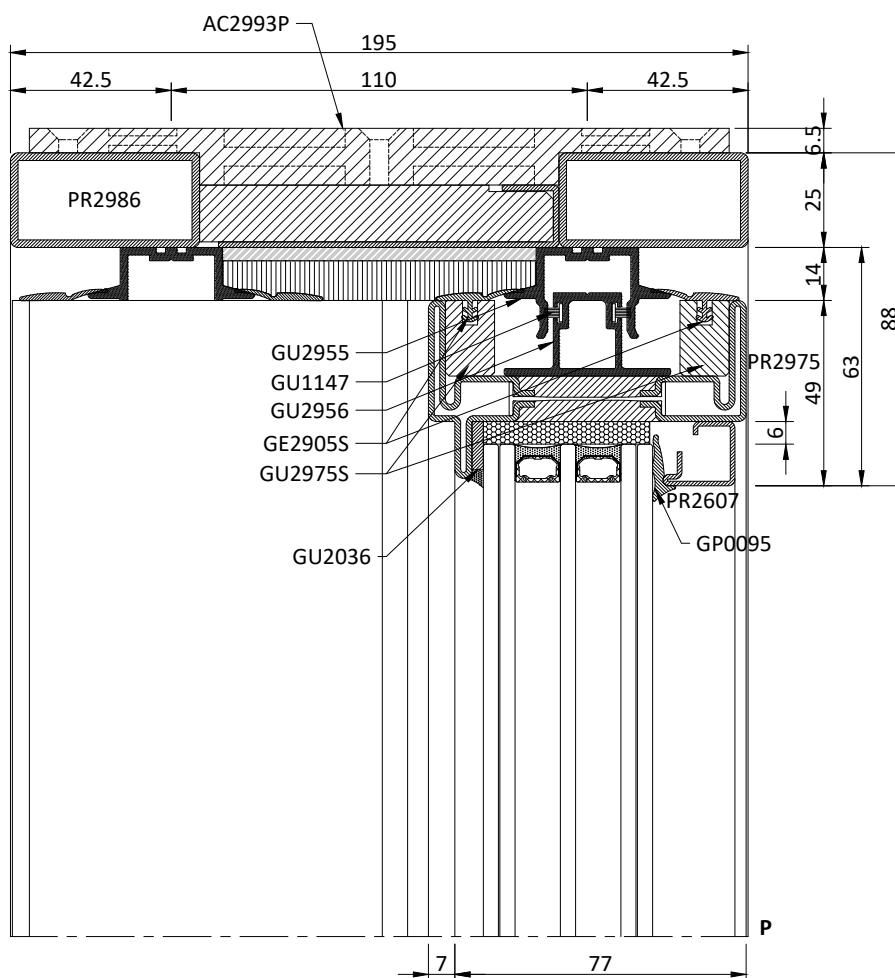
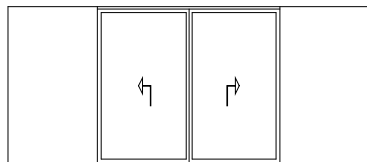

Schema | Type A

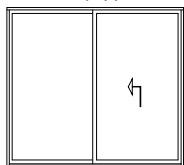

Schema | Type B

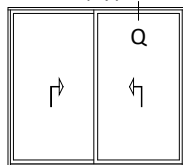

Schema | Type E

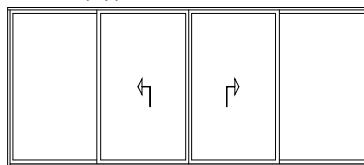

Schema | Type F

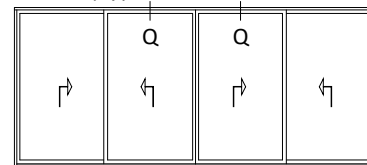

Schema | Type S1

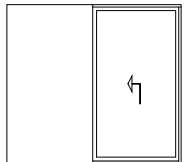

Schema | Type T1

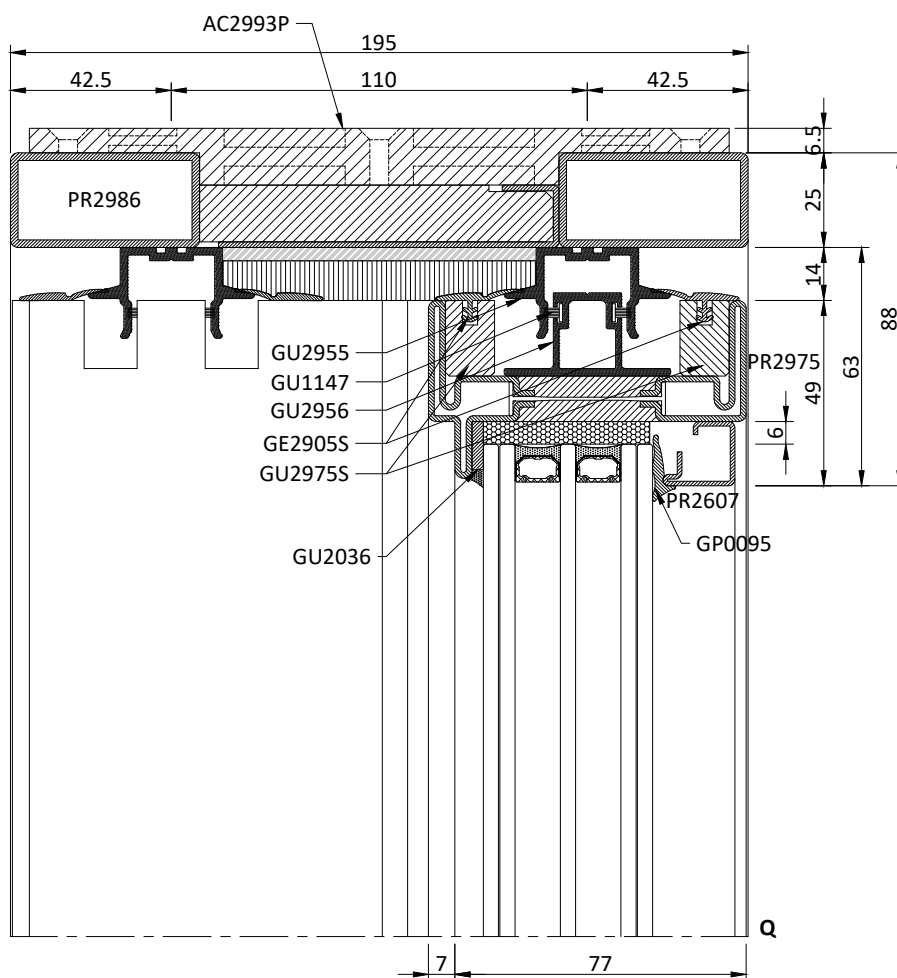
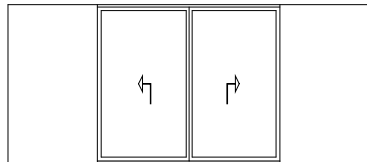

Schema | Type A

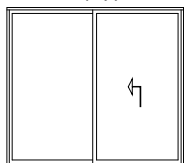

Schema | Type B

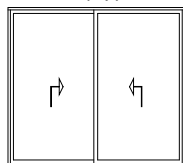

Schema | Type E

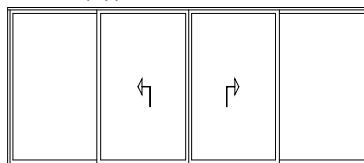

Schema | Type F

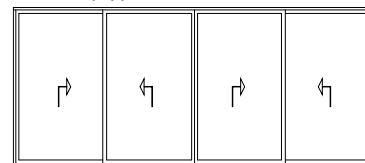

Schema | Type S1

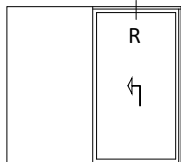

Schema | Type T1

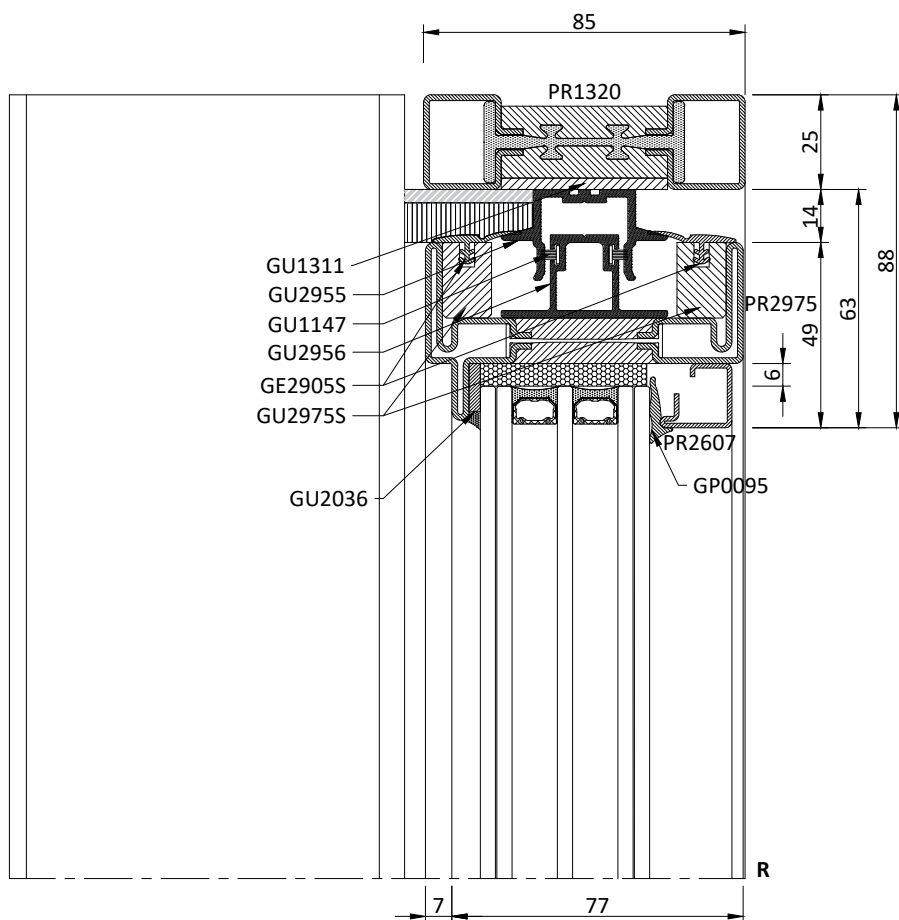
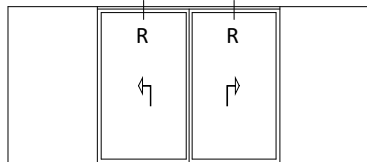

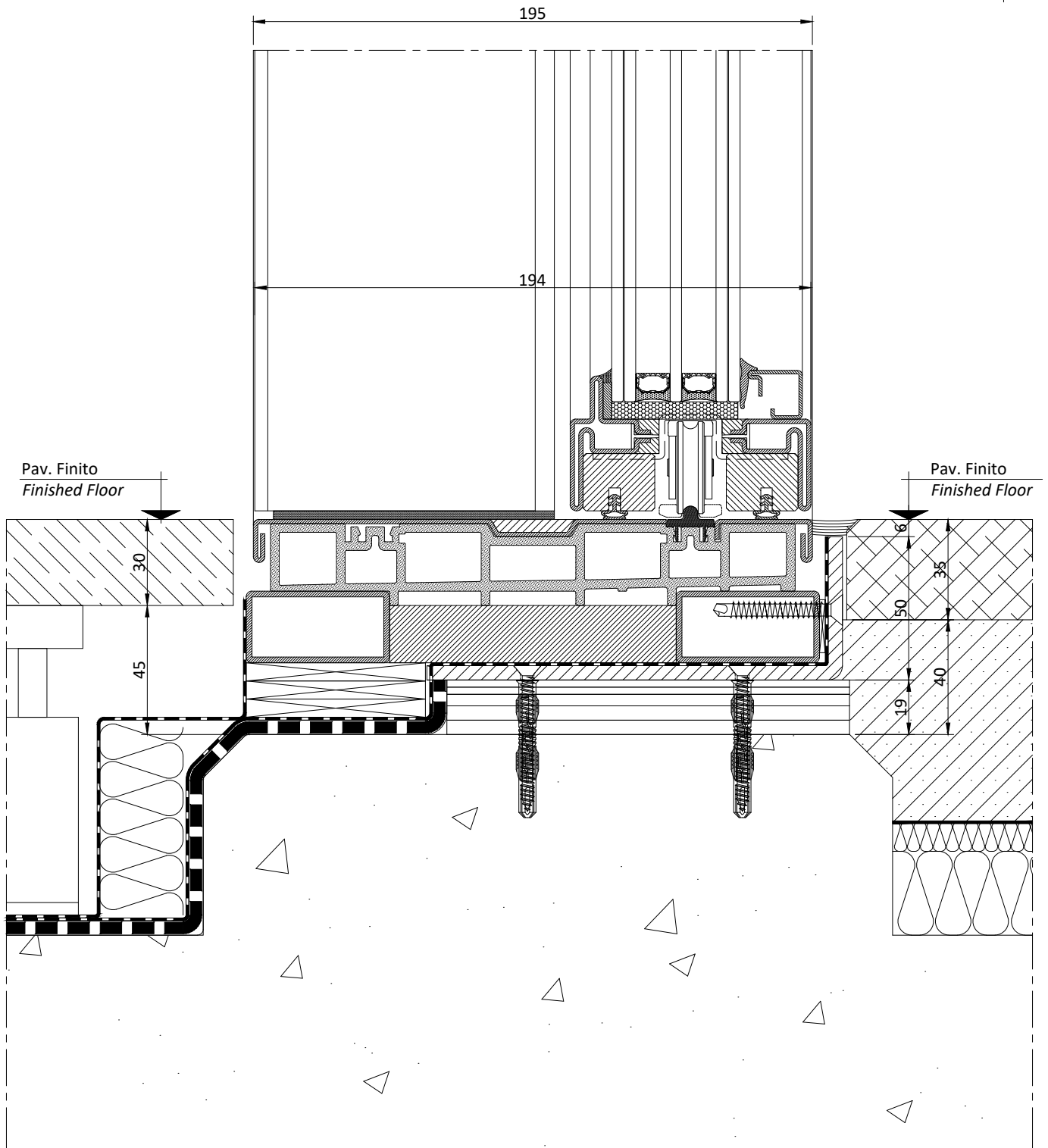
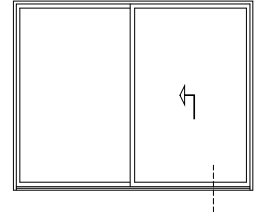

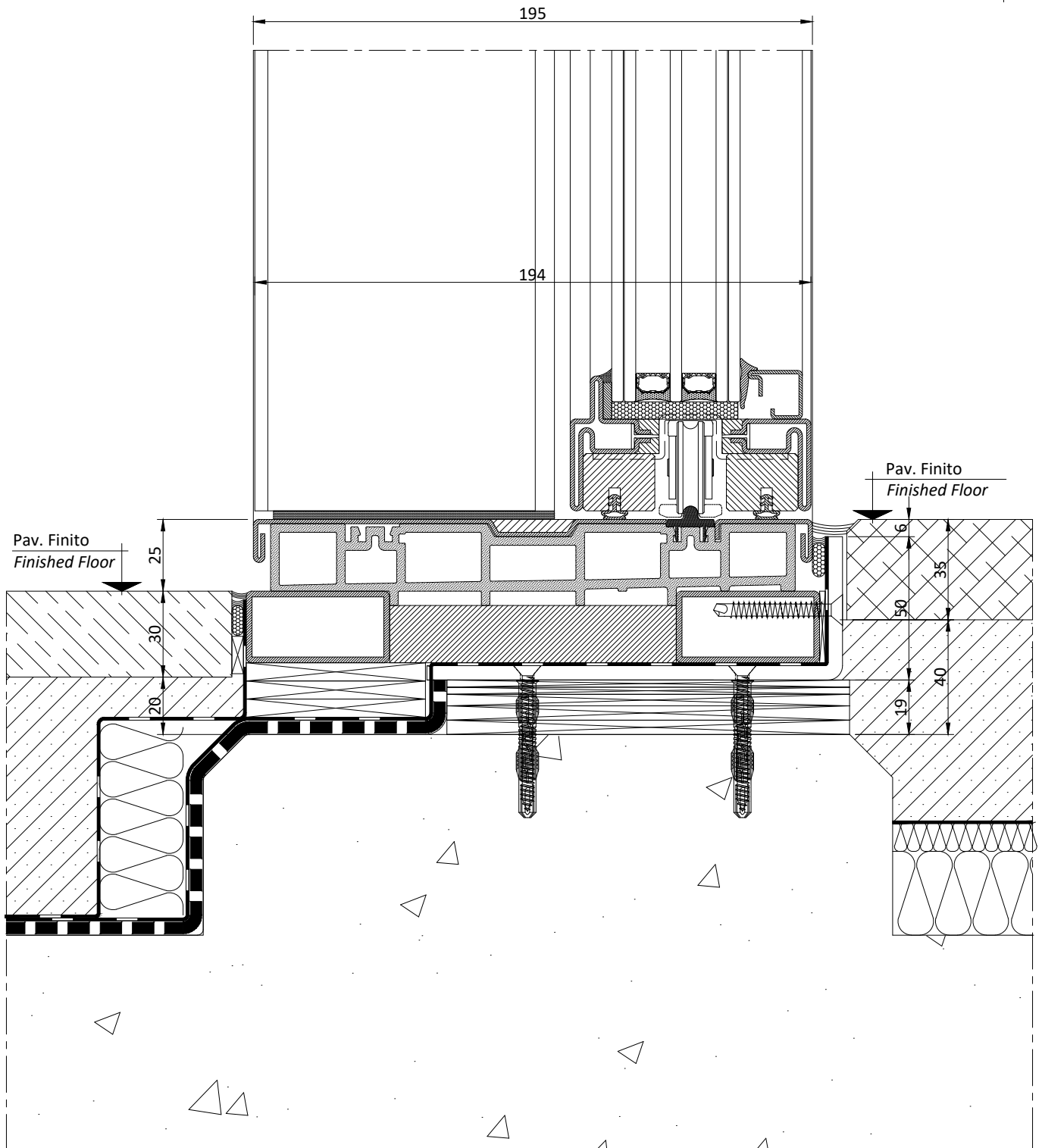
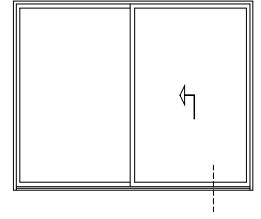

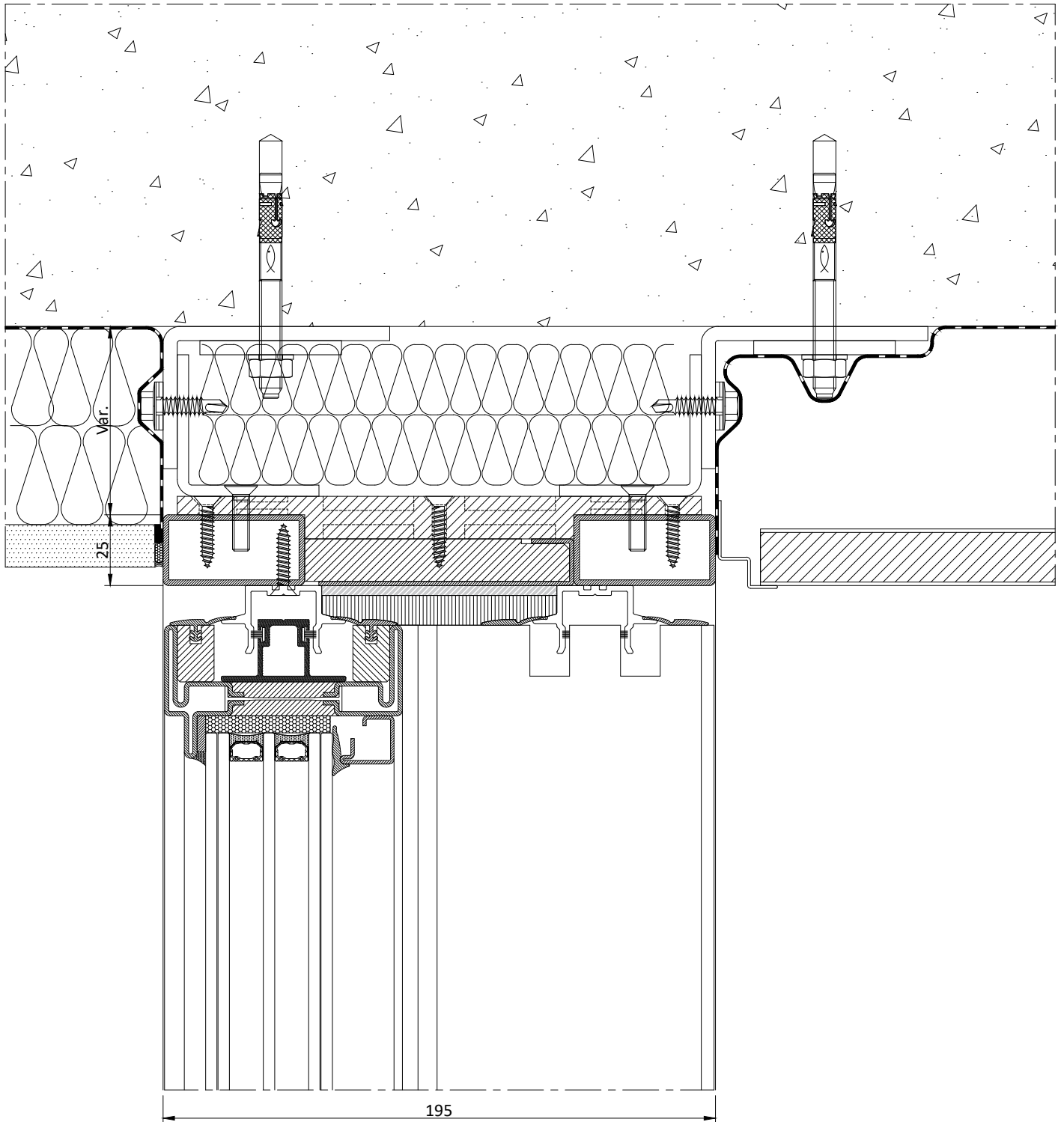
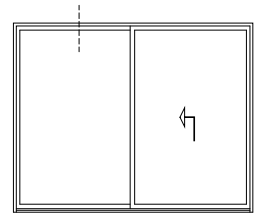

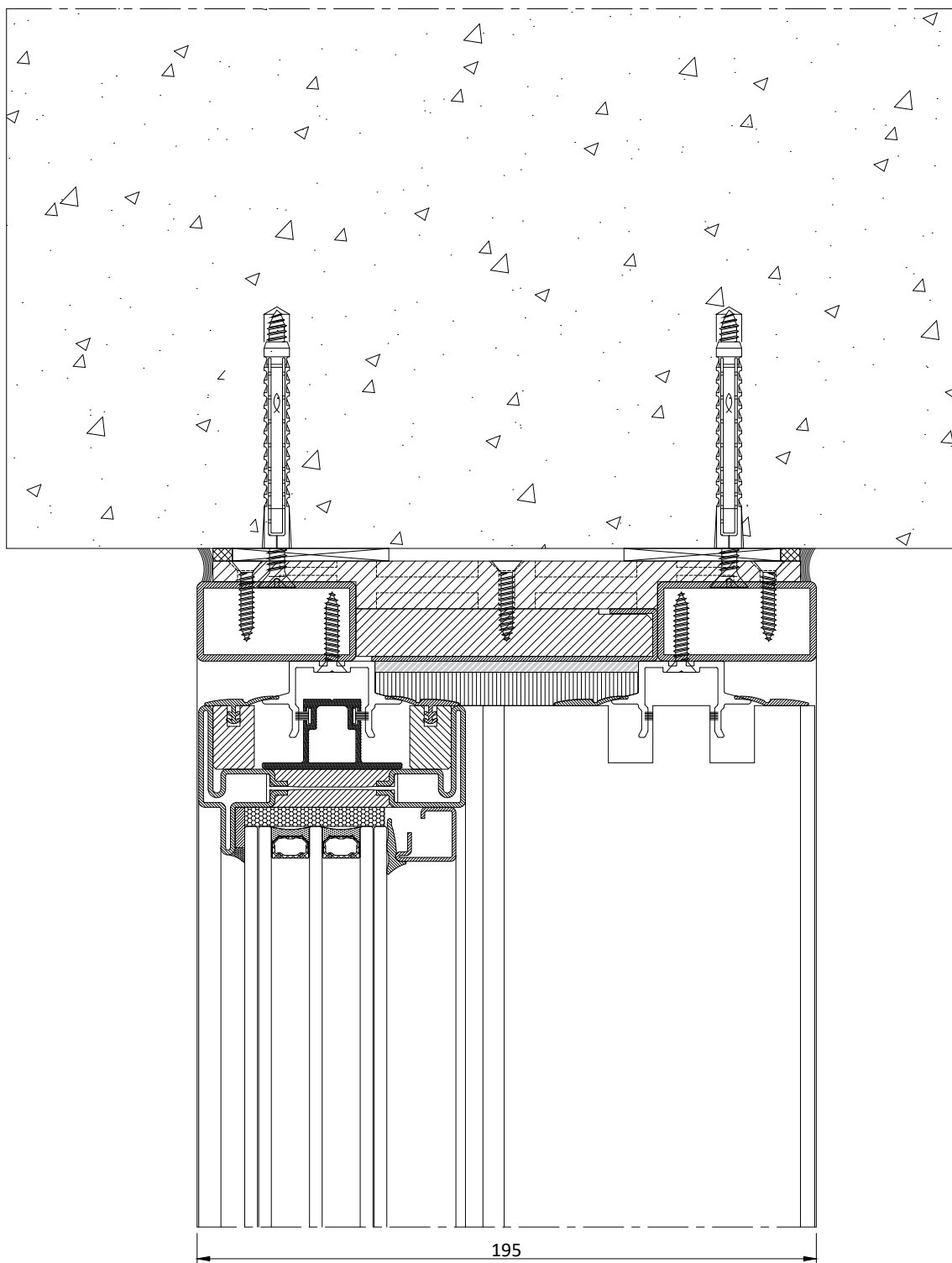
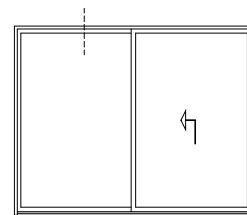

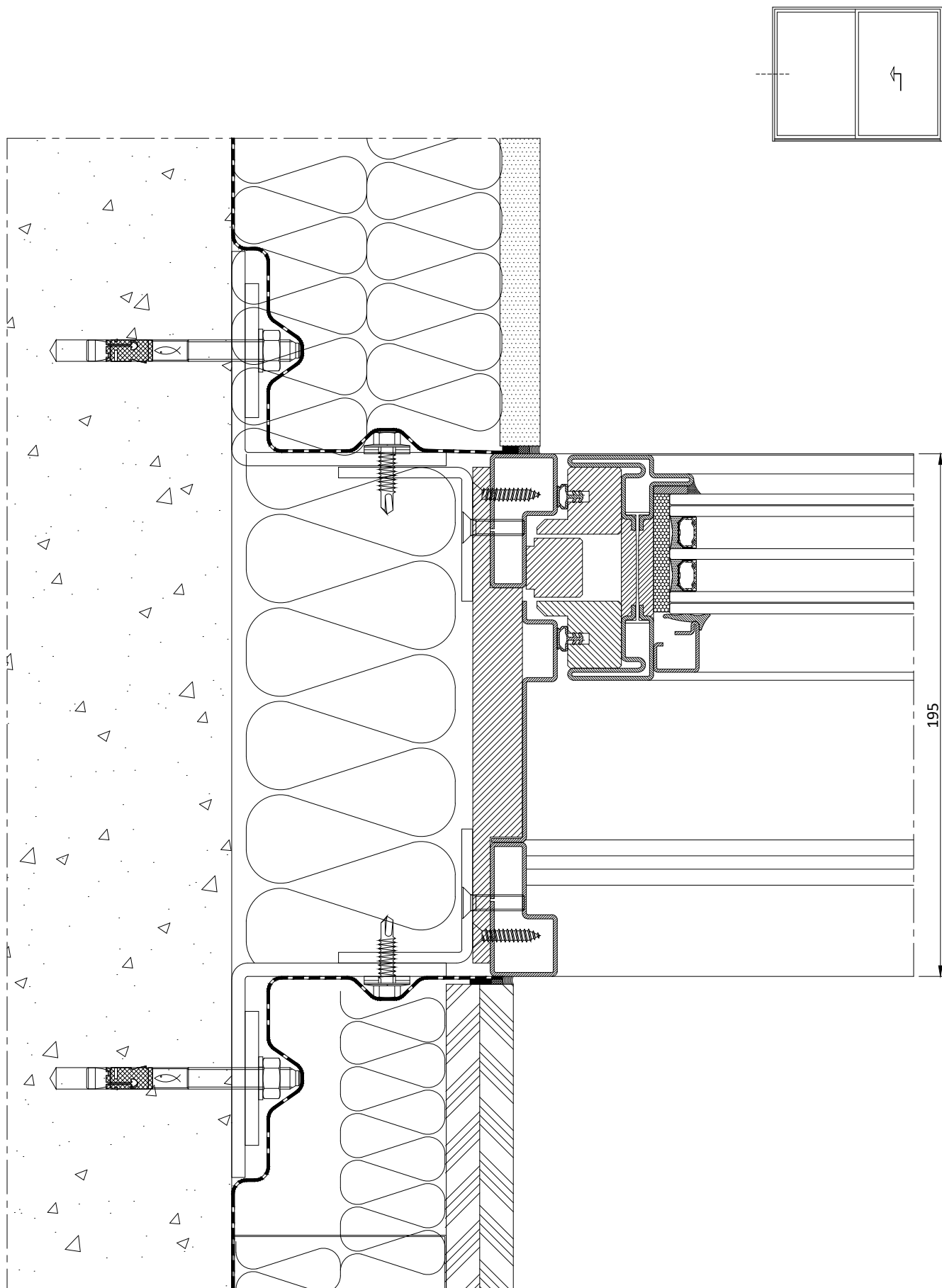

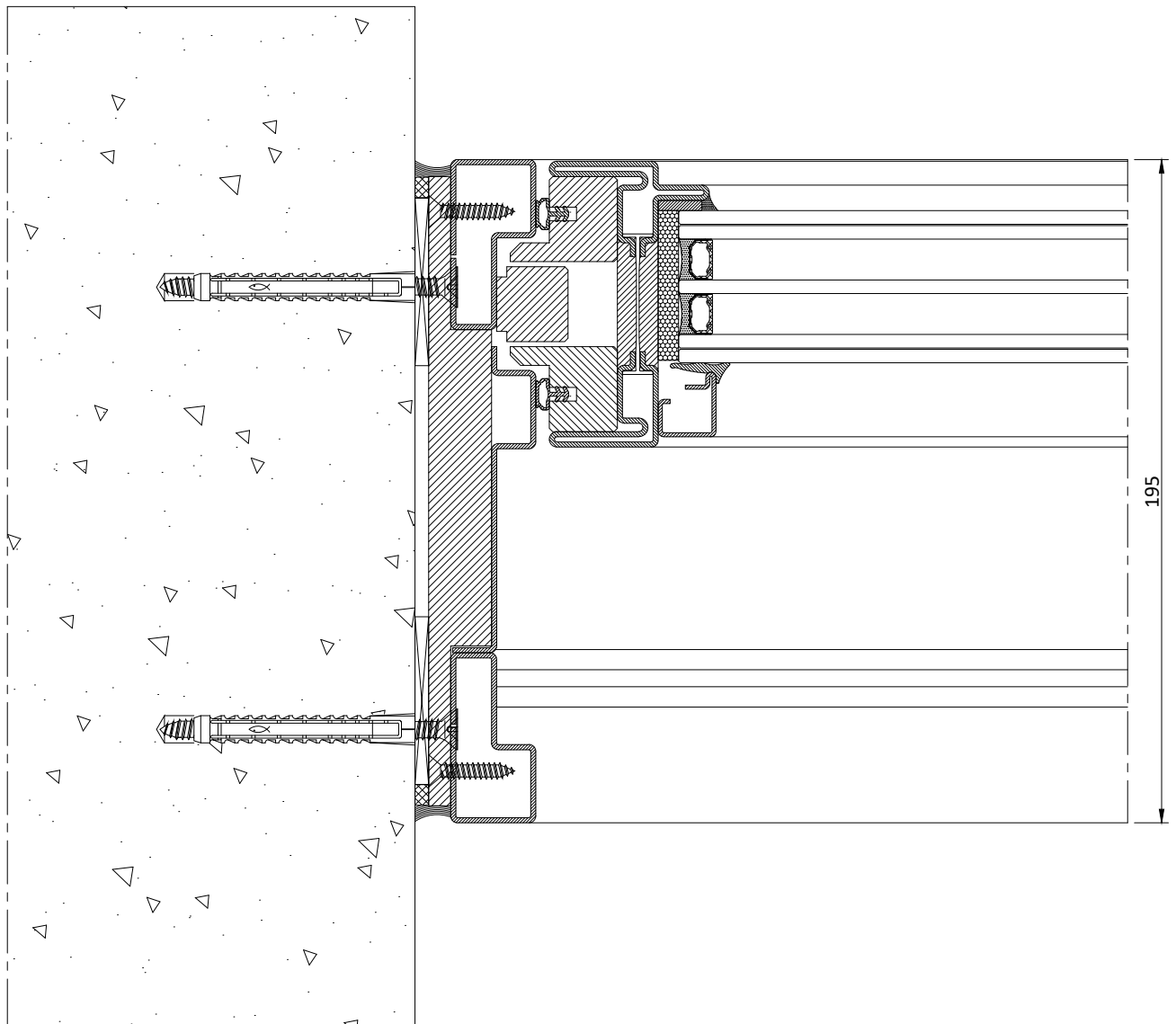
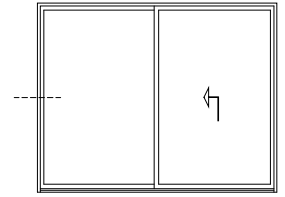

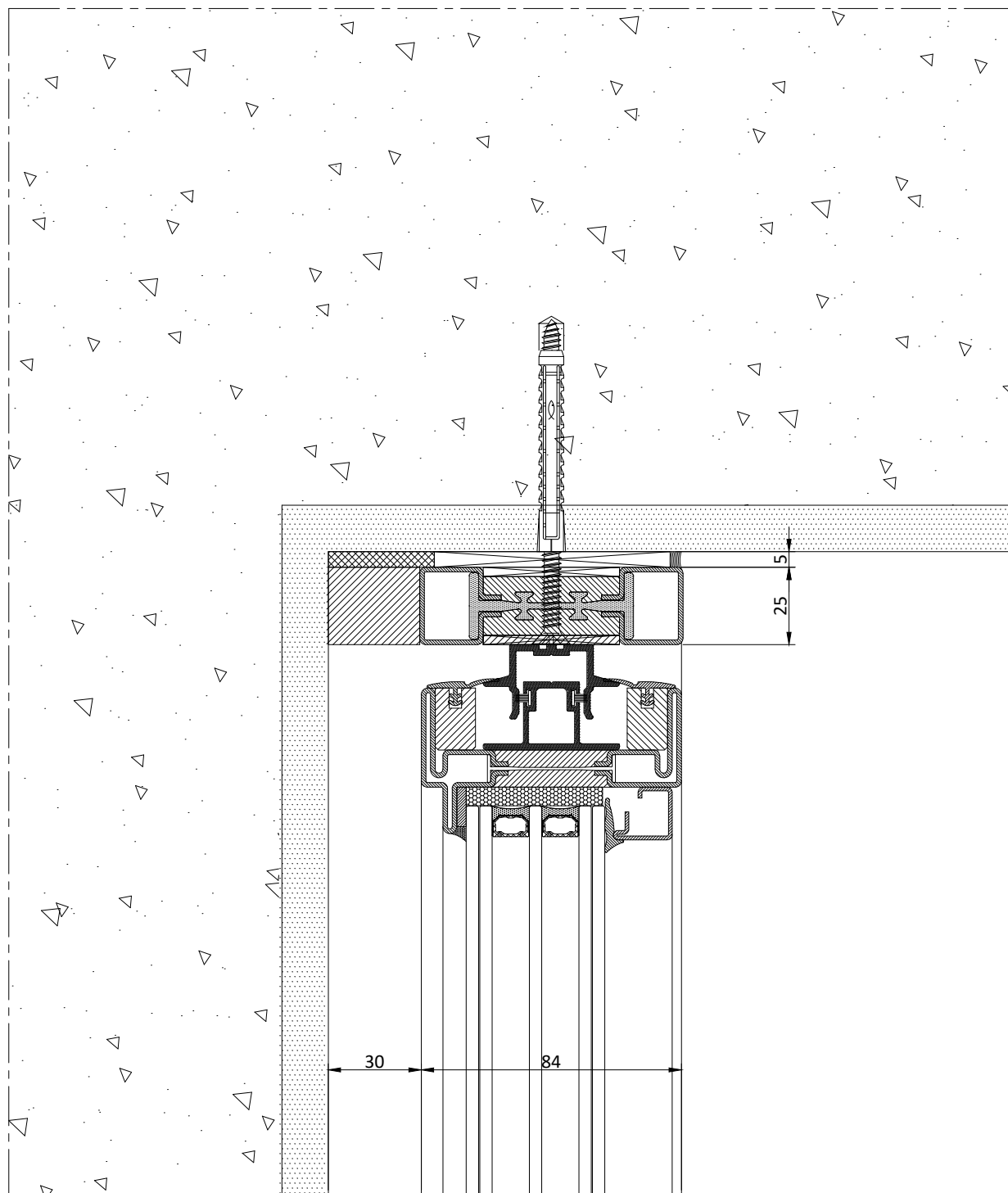
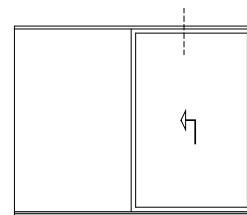

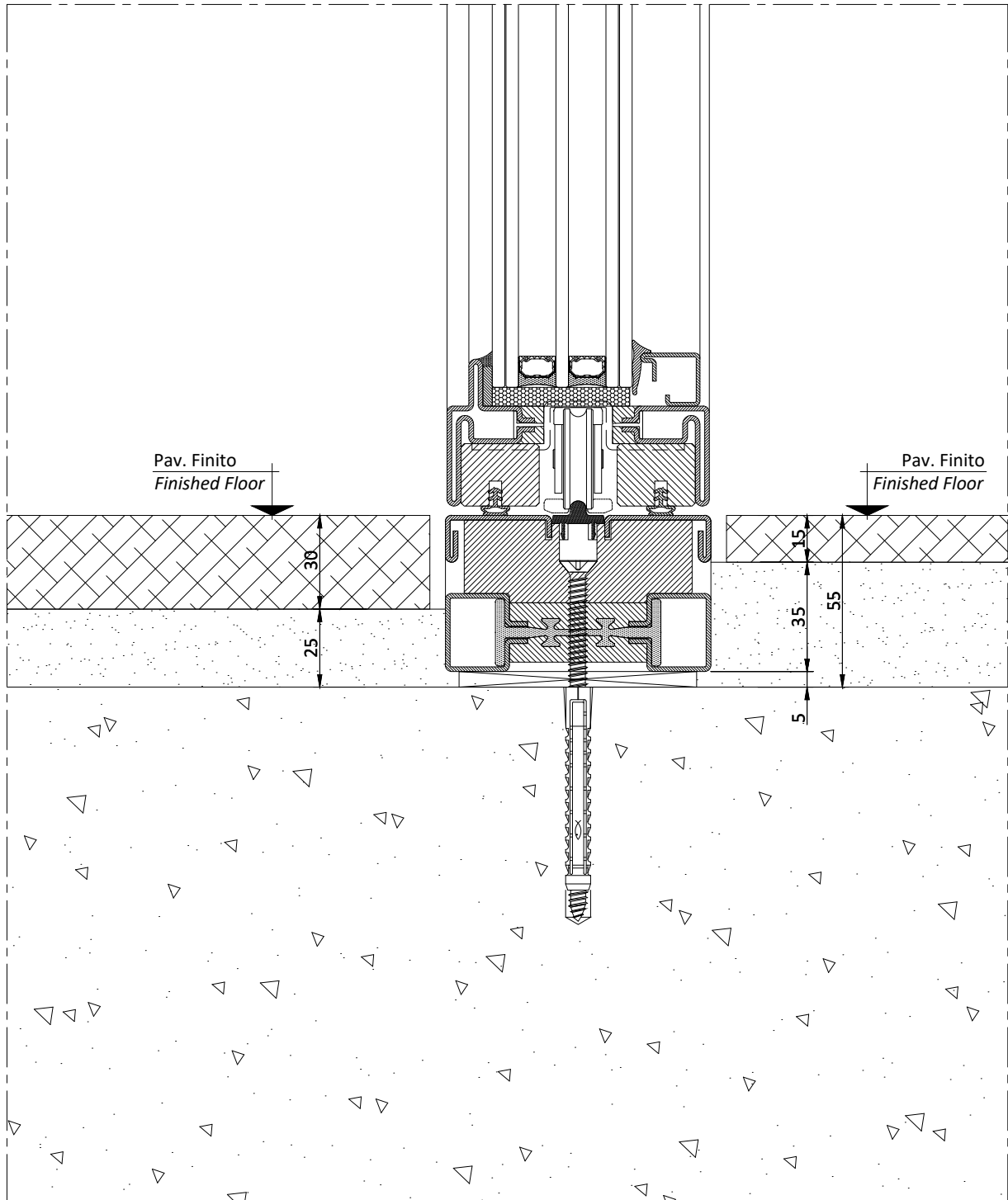
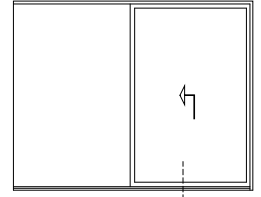

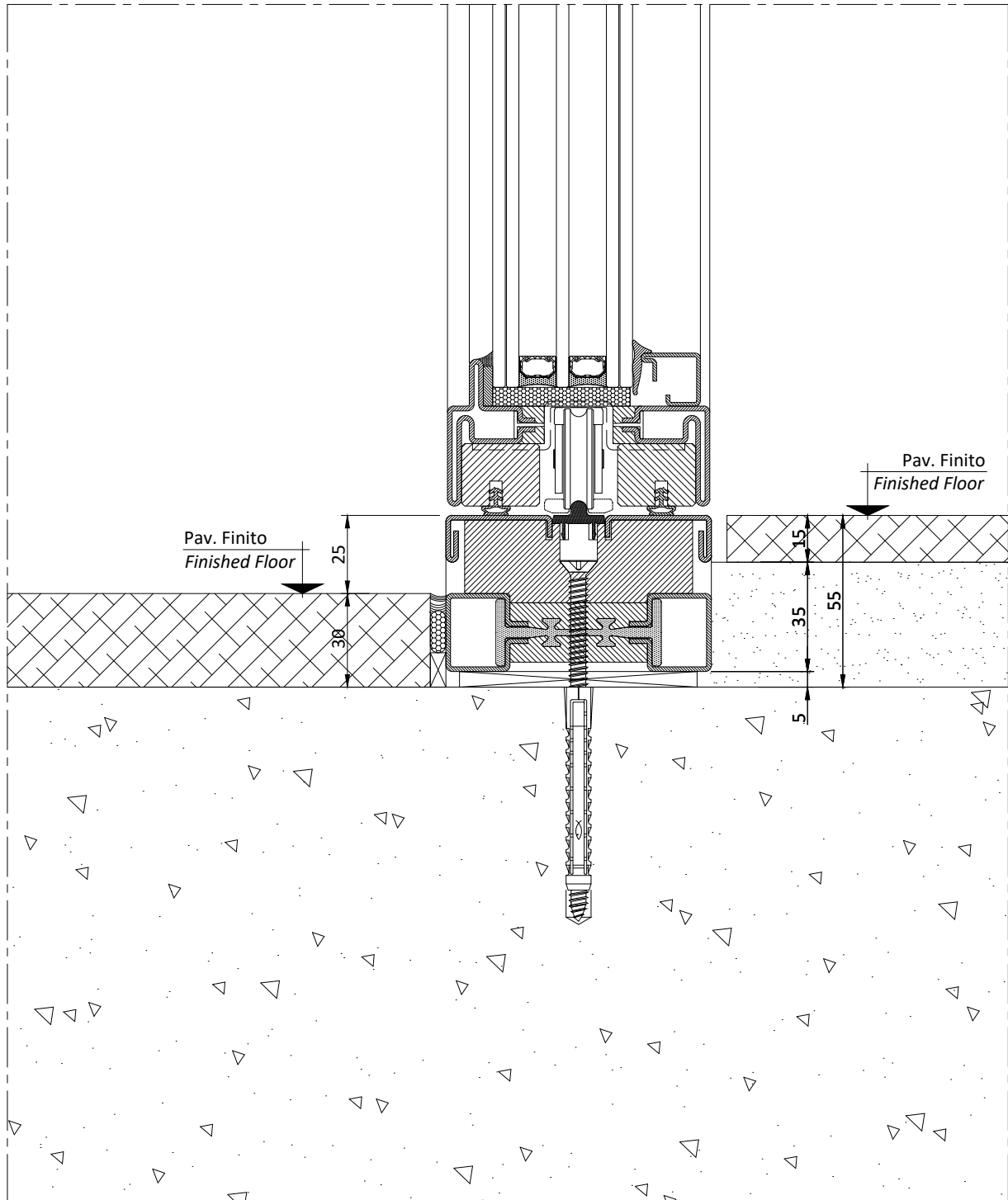
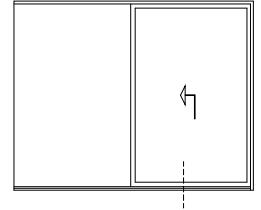

Distinta di taglio e lista componenti | Cutting list and components list

Le distinte di taglio e le liste accessori individuate per le diverse tipologie sono state redatte per un serramento tipo. E' compito dei tecnici specializzati delle ditte produttrici analizzare criticamente tali indicazioni al fine di verificare la compatibilità del tipo e numero di accessori previsti con il serramento oggetto della commessa reale.

The cutting and hardware lists, which have been identified for the different typologies, have been produced for a standard window. The window manufacturers' specialized technicians will have to critically analyze such information in order to verify the compatibility of both the type and the number of accessories provided with the window object of the real order.

Schema | Type A

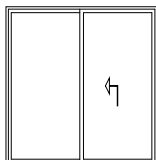

Schema | Type B

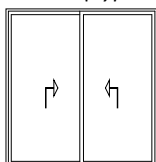

Schema | Type E

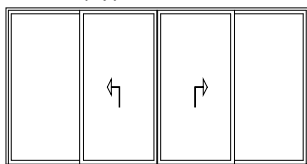

Schema | Type F

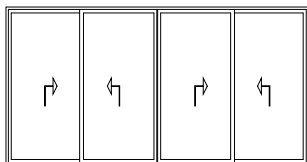

Schema | Type S1

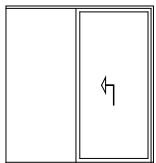

Schema | Type T1

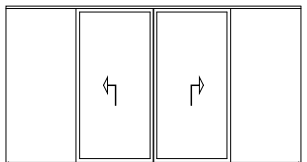

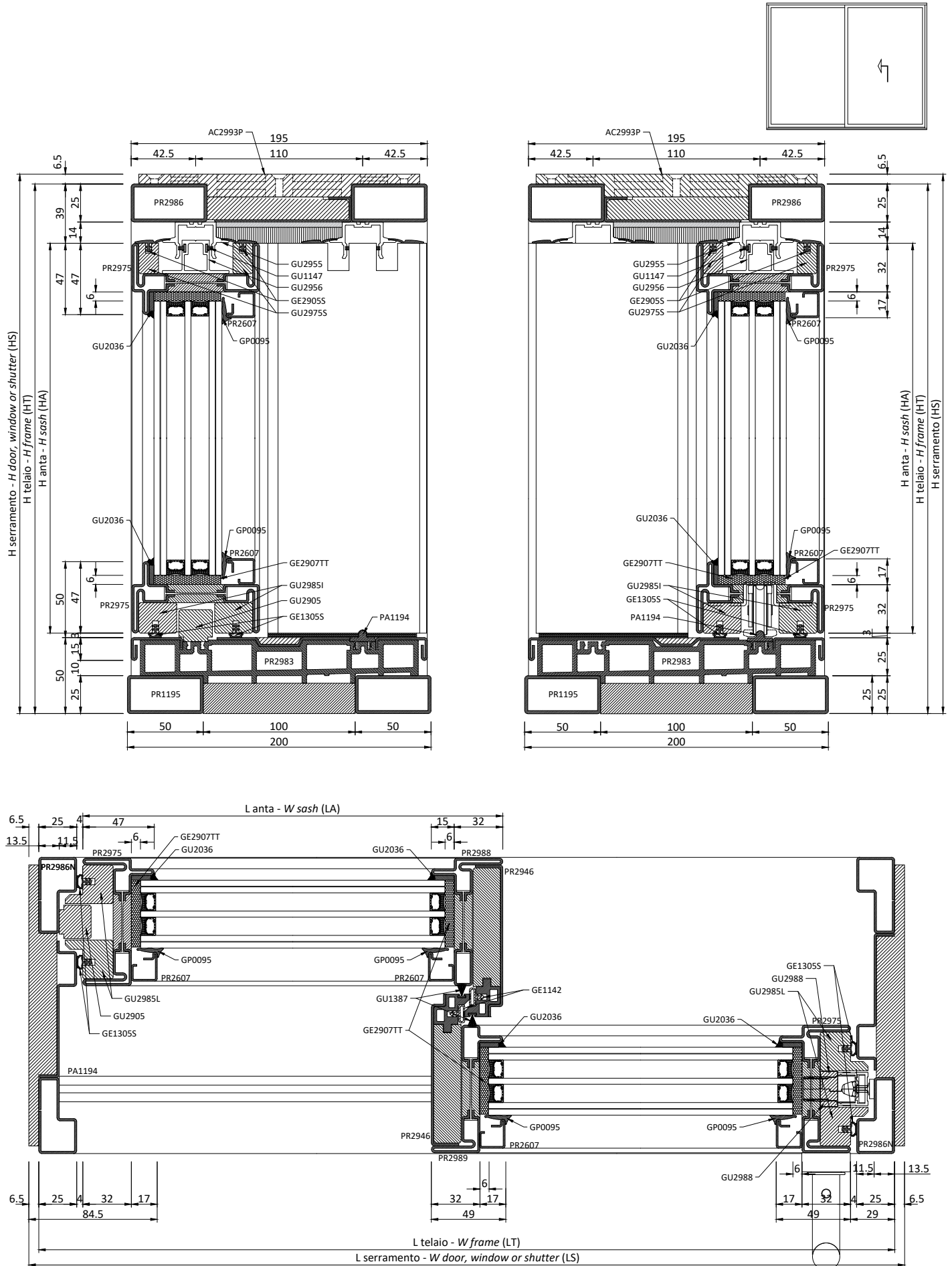

PROFILI		PROFILES			
Cod.	Descrizione	Description	n°	Dim.	Taglio/Cutting
Telaio		Frame			
PR2986	Profilo 50x25	Profile 50x25	2	LT	90 90
	Estruso centrale di unione	Central extrusion junction	2	LT/2	90 90
	Profilo centrale a "C"	"C" profile	2	LT/2-2,5	90 90
PR2986A	Profilo stampato	Metal sheet	4	LT-50	90 90
	Profilo centrale a "C"	C-shaped profile	2	LT-50	90 90
	Estruso centrale di unione	Lower frame - polyamide profile	2	LT-50	90 90
PR1195	Tubo 50x25 mm	50x25 mm stainless steel tube	2	LT	90 90
	Estruso centrale di unione	Central extrusion junction	1	LT	90 90
PR2983	Telaio base - copertina interna (Part. A)	Lower frame - internal cover (Detail A)	1	LT-27	90 90
	Telaio base - copertina centrale (Part. B)	Lower frame - central cover (Detail B)	1	LT/2-42	90 90
	Telaio base - copertina esterna (Part. C)	Lower frame - external cover (Detail C)	1	LT/2-14	90 90
	Telaio base - copertina esterna (Part. A)	Lower frame - external cover (Detail A)	1	LT/2-14	90 90
	Telaio base - profilo poliammide di supporto	Lower frame - polyamide profile of rails	2	LT-29	90 90
Guide		Rail			
GU2955	Profilo guida superiore anta mobile	Upper rail of sliding sash	1	LT-27	90 90
	Profilo guida superiore anta fissa	Upper rail of fixed sash	1	LT/2+9	90 90
GU2956	Pattino di scorrimento anta mobile e fissa	Runner for sliding and fixed sash	2	LT/2-10	90 90
PA1194	Profilo guida inferiore	Lower profile	1	LT-27	90 90
Anta		Sash			
PR2975	Profilo zoccolo	Bottom rail profile	4	LT/2-6	45 45
	Profilo zoccolo	Bottom rail profile	2	HT-92	45 45
PR2988	Profilo a "T"	"T" profile	1	HT-92	45 45
PR2989	Profilo a "Z"	"Z" profile	1	HT-92	45 45
PR2946	Profilo labirinto centrale - anta mobile (Part. 1)	Central labyrinth profile - sliding sash (Detail 1)	2	HT-92	90 90
	Profilo labirinto centrale - anta mobile (Part. 2)	Central labyrinth profile - sliding sash (Detail 2)	2	HT-92	90 90
GU2985L	Profilo plastico porta guarnizione perimetrale verticale	Plastic door vertical profile perimeter gasket	4	HT-92	45 45
GU2985I	Profilo plastico porta guarnizione inferiore	Plastic door profile lower gasket	4	LT/2-26	45 90
GU2975S	Profilo plastico porta guarnizione superiore	Plastic door profile upper gasket	4	LT/2-26	90 45
GU2988	Profilo plastico per spessore cremonese	Plastic profile for cremonese thickness	1	HT-249	90 90
GU2905	Estruso di compensazione	Compensation extrusion	1	HT-115	90 90
	Estruso di compensazione	Compensation extrusion	1	LT/2-60	90 90
Fermavetri		Glazing beads			
PR2607	Profilo fermavetro	Glazing bead profile	4	LT/2-72	45 45
	Profilo fermavetro	Glazing bead profile	4	HT-156	45 45
Vetri		Glass unit			
	Vetrocamera	Double glazing	2	LT/2-84 x HT-168	
ACCESSORI		HARDWARE			
Cod.	Descrizione	Description	n°	Note/Notes	
AC290ANT	Kit squadrette di giunzione ante	Corner joint kit Sashes	2		
AG2992.AB	Rostro aggiuntivo	Additional hook bolt	opz.		
AG2989.AB	Kit prolungha aggiuntiva cremonese	Additional extension for cremonese bolt set	opz.		
AG2986 7A.xx	Kit alzante scorrevole	Lift and slide kit	1		
ACV__	Maniglione	Large handle	1		
AC2993P	Accessorio assiemaggio telaio	Frame assemblage accessory	var.		
AC1305G	Angolo vulcanizzato per GE1305S	Vulcanised corner gasket for GE1305S	4		
AC298TES.xx	Kit piastrine di giunzione telaio esterno	Kit of external frame junction plates	1		
CV5403I	Rondella in acciaio inox/epdm	Stainless steel/vulcanised epdm washer	var.		
AC2608	Clips fissaggio fermavetri	Clips for glazing bead	var.		
GUARNIZIONI*		GASKETS*			
Cod.	Descrizione	Description	n°	Dim.	
GU2036	Piattina adesiva morbida esterno vetro	Soft adhesive shim for external window	1	2xLT+4xHT	
GU2907TT	Guarnizione sotto vetro	Under glass gasket	1	2xLT+4xHT	
GP0095	Guarnizione interna vetro	Internal glass gasket	1	2xLT+4xHT	
GE2905S	Guarnizione superiore ante	Gasket for upper sash	2	LT	
GE1305S	Guarnizione perimetrale ante	Gasket for side sash	1	2xLT+4xHT	
GE1142	Guarnizione labirinto centrale	Gasket for central labyrinth	2	HT	
GU1387	Spazzolino verticale labirinto	Vertical labyrinth brush + adhesive	2	HT	
GU1147	Spazzolino tenuta superiore anta mobile	Upper sealing brush for sliding sash	2	LT	

* le dimensioni delle guarnizioni sono indicative e devono essere aumentate del 10% per adattamenti e ritiri del materiale nel tempo

* the gasket dimensions are indicative and have to be increased by 10% owing to adaptation and contraction of the material over time

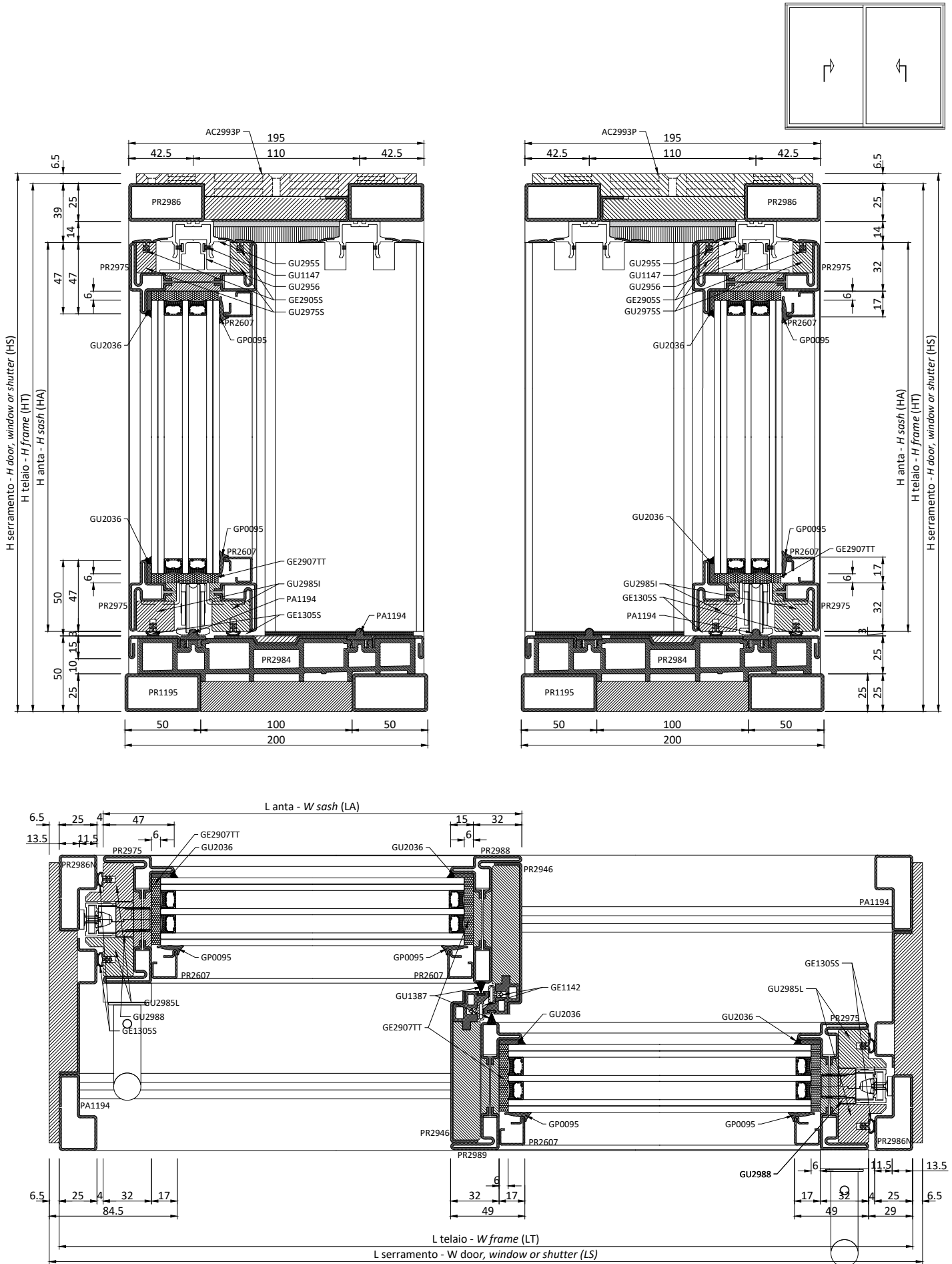

PROFILI		PROFILES				
Cod.	Descrizione	Description	n°	Dim.	Taglio/Cutting	
Telaio		Frame				
PR2986	Profilo 50x25	Profile 50x25	2	LT	90	90
	Estruso centrale di unione	Central extrusion junction	2	LT/2	90	90
	Profilo centrale a "C"	"C" profile	2	LT/2-2,5	90	90
PR2986N	Profilo stampato	Metal sheet	4	LT-50	90	90
	Profilo centrale a "C"	C-shaped profile	2	LT-50	90	90
	Estruso centrale di unione	Lower frame - polyamide profile	2	LT-50	90	90
PR1195	Tubo 50x25 mm	50x25 mm stainless steel tube	2	LT	90	90
	Estruso centrale di unione	Central extrusion junction	1	LT	90	90
PR2984	Telaio base - copertina interna (Part. A)	Lower frame - internal cover (Detail A)	1	LT-27	90	90
	Telaio base - copertina centrale (Part. B)	Lower frame - central cover (Detail B)	2	LT/2-42	90	90
	Telaio base - copertina esterna (Part. A)	Lower frame - external cover (Detail A)	1	LT-27	90	90
	Telaio base - profilo poliammide di supporto	Lower frame - polyamide profile of rails	2	LT-29	90	90
Guide		Rail				
GU2955	Profilo guida superiore anta mobile	Upper rail of sliding sash	2	LT-27	90	90
GU2956	Pattino di scorrimento ante mobili	Runner for sliding sash	2	LT/2-10	90	90
PA1194	Profilo guida inferiore	Lower profile	1	LT-27	90	90
Anta		Sash				
PR2975	Profilo zoccolo	Bottom rail profile	4	LT/2-6	45	45
	Profilo zoccolo	Bottom rail profile	2	HT-92	45	45
PR2988	Profilo a "T"	"T" profile	1	HT-92	45	45
PR2989	Profilo a "Z"	"Z" profile	1	HT-92	45	45
PR2946	Profilo labirinto centrale - anta mobile (Part. 1)	Central labyrinth profile - sliding sash (Detail 1)	2	HT-92	90	90
	Profilo labirinto centrale - anta mobile (Part. 2)	Central labyrinth profile - sliding sash (Detail 2)	2	HT-132	90	90
GU2985L	Profilo plastico porta guarnizione perimetrale verticale	Plastic door vertical profile perimeter gasket	4	HT-92	45	45
GU2985I	Profilo plastico porta guarnizione inferiore	Plastic door profile lower gasket	4	LT/2-26	45	90
GU2975S	Profilo plastico porta guarnizione superiore	Plastic door profile upper gasket	4	LT/2-26	90	45
GU2988	Profilo plastico per spessore cremonese	Plastic profile for cremonese thickness	2	LT-249	90	90
Fermavetri		Glazing beads				
PR2607	Profilo fermavetro	Glazing bead profile	4	LT/2-72	45	45
	Profilo fermavetro	Glazing bead profile	4	HT-156	45	45
Vetri		Glass unit				
	Vetrocamera	Double glazing	2	LT/2-84 x HT-168		
ACCESSORI		HARDWARE				
Cod.	Descrizione	Description	n°	Note/Notes		
AC290ANT	Kit squadrette di giunzione ante	Corner joint kit Sashes	2			
AG2992.AB	Rostro aggiuntivo	Additional hook bolt	opz.			
AG2989.AB	Kit prolungha aggiuntiva cremonese	Additional extension for cremonese bolt set	opz.			
AG2986 7B.xx	Kit alzante scorrevole	Lift and slide kit	1			
ACV__	Maniglione	Large handle	2			
AC2993P	Accessorio assiemaggio telaio	Frame assemblage accessory	var.			
AC1305G	Angolo vulcanizzato per GE1305S	Vulcanised corner gasket for GE1305S	4			
AC298TES.xx	Kit piastrene di giunzione telaio esterno	Kit of external frame junction plates	1			
CV5403I	Rondella in acciaio inox/epdm	Stainless steel/vulcanised epdm washer	var.			
AC2608	Clips fissaggio fermavetri	Clips for glazing bead	var.			
GUARNIZIONI*		GASKETS*				
Cod.	Descrizione	Description	n°	Dim.		
GU2036	Piattina adesiva morbida esterno vetro	Soft adhesive shim for external window	1	2xLT+4xHT		
GU2907TT	Guarnizione sotto vetro	Under glass gasket	1	2xLT+4xHT		
GP0095	Guarnizione interna vetro	Internal glass gasket	1	2xLT+4xHT		
GE2905S	Guarnizione superiore ante	Gasket for upper sash	2	LT		
GE1305S	Guarnizione perimetrale ante	Gasket for side sash	2	2xLT/2+2xHT		
GE1142	Guarnizione labirinto centrale	Gasket for central labyrinth	2	HT		
GU1387	Spazzolino verticale labirinto	Vertical labyrinth brush + adhesive	1	HT		
GU1147	Spazzolino tenuta superiore anta mobile	Upper sealing brush for sliding sash	4	LT/2		

* le dimensioni delle guarnizioni sono indicative e devono essere aumentate del 10% per adattamenti e ritiri del materiale nel tempo

* the gasket dimensions are indicative and have to be increased by 10% owing to adaptation and contraction of the material over time

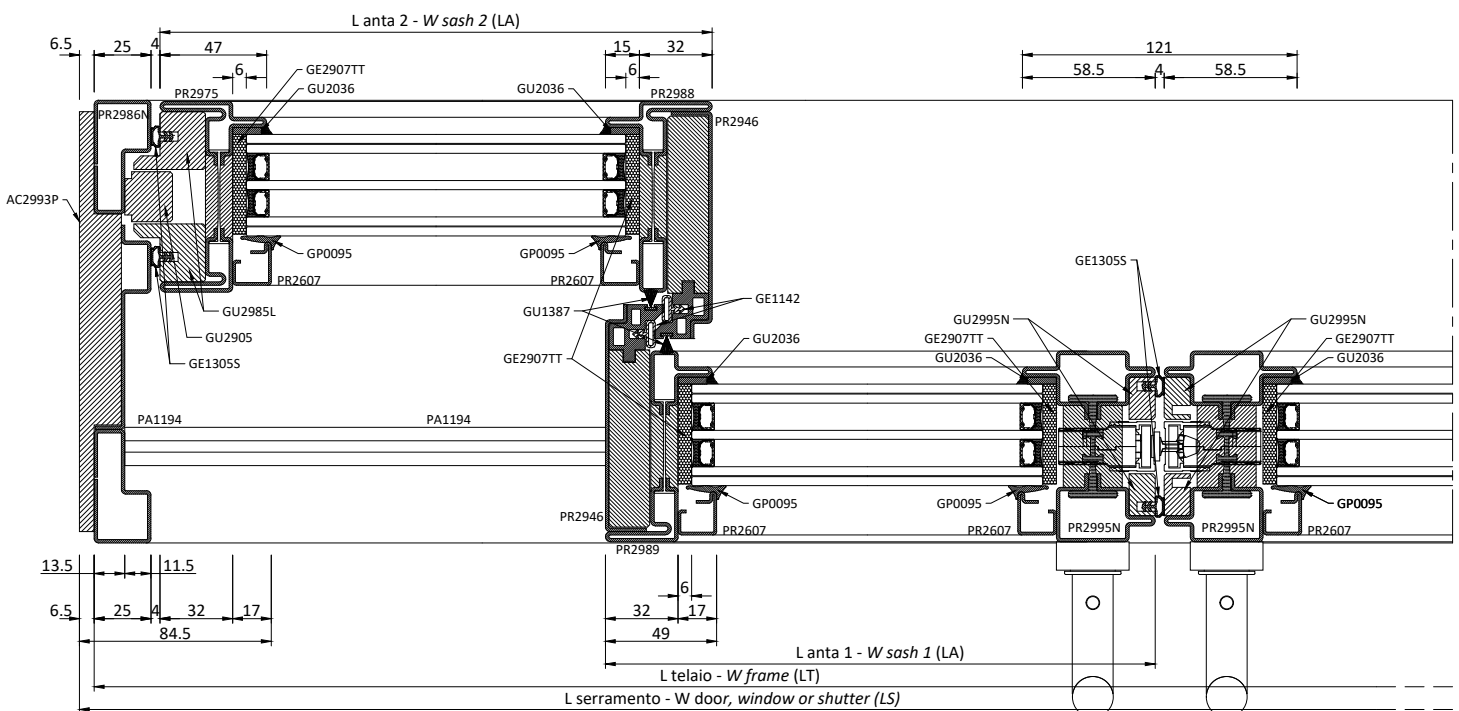
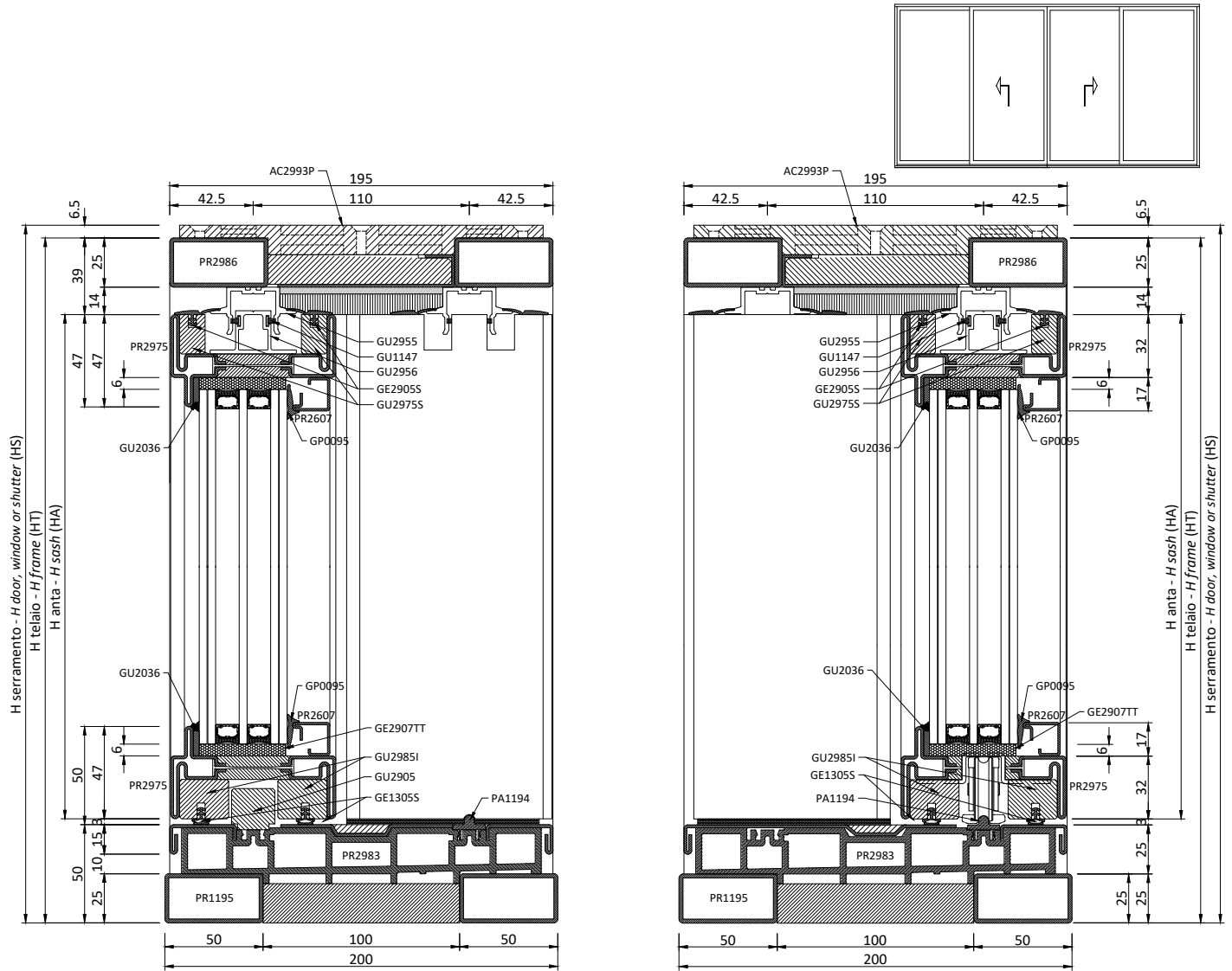

PROFILI		PROFILES				
Cod.	Descrizione	Description	n°	Dim.	Taglio/Cutting	
Telaio		Frame				
PR2986	Profilo 50x25	Profile 50x25	2	LT	90	90
	Estruso centrale di unione	Central extrusion junction	2	LT/2	90	90
PR2986N	Profilo centrale a "C"	"C" profile	2	LT/2-2,5	90	90
	Profilo stampato	Metal sheet	4	LT-50	90	90
	Profilo centrale a "C"	C-shaped profile	2	LT-50	90	90
PR1195	Estruso centrale di unione	Lower frame - polyamide profile	2	LT-50	90	90
	Tubo 50x25 mm	50x25 mm stainless steel tube	2	LT	90	90
PR2983	Estruso centrale di unione	Central extrusion junction	1	LT	90	90
	Telaio base - copertina interna (Part. A)	Lower frame - internal cover (Detail A)	1	LT-27	90	90
	Telaio base - copertina centrale (Part. B)	Lower frame - central cover (Detail B)	2	LT/4-33	90	90
	Telaio base - copertina esterna (Part. C)	Lower frame - external cover (Detail C)	1	LT/2-17	90	90
	Telaio base - copertina esterna (Part. A)	Lower frame - external cover (Detail A)	2	LT/4-5	90	90
	Telaio base - profilo poliammide di supporto	Lower frame - polyamide profile of rails	2	LT-29	90	90
Guide		Rail				
GU2955	Profilo guida superiore anta mobile	Upper rail of sliding sash	1	LT-27	90	90
	Profilo guida superiore anta fissa	Upper rail of fixed sash	2	LT/4+15	90	90
GU2956	Pattino di scorrimento anta mobile e fissa	Runner for sliding and fixed sash	4	LA-4	90	90
PA1194	Profilo guida inferiore	Lower profile	1	LT-27	90	90
Anta		Sash				
PR2975	Profilo zoccolo	Bottom rail profile	8	LT/4+3	45	45
	Profilo zoccolo	Bottom rail profile	2	HT-92	45	45
PR2995N	Profilo zoccolo	Bottom rail profile	2	HT-69	45	45
PR2988	Profilo a "T"	"T" profile	2	HT-92	45	45
PR2989	Profilo a "Z"	"Z" profile	2	HT-92	45	45
PR2946	Profilo labirinto centrale - anta mobile (Part. 1)	Central labyrinth profile - sliding sash (Detail 1)	2	HT-92	90	90
	Profilo labirinto centrale - anta mobile (Part. 2)	Central labyrinth profile - sliding sash (Detail 2)	2	HT-92	90	90
GU2985L	Profilo plastico porta guarnizione perimetrale verticale	Plastic door vertical profile perimeter gasket	4	HT-69	45	45
GU2985I	Profilo plastico porta guarnizione inferiore	Plastic door profile lower gasket	4	LT/4-17	45	90
GU2985I	Profilo plastico porta guarnizione inferiore	Plastic door profile lower gasket	4	LT/4-6	45	90
GU2975S	Profilo plastico porta guarnizione superiore	Plastic door profile upper gasket	4	LT/4-17	90	45
GU2975S	Profilo plastico porta guarnizione superiore	Plastic door profile upper gasket	4	LT/4-19	90	90
GU2995N	Profilo plastico porta guarnizione centrale	Plastic door profile central gasket	2	LT-92	90	45
GU2995N	Profilo plastico porta guarnizione centrale	Plastic door profile central gasket	2	LT-92	45	90
GU2905	Estruso di compensazione	Compensation extrusion	2	HT-115	90	90
	Estruso di compensazione	Compensation extrusion	2	LT/4-60	90	90
Fermavetri		Glazing beads				
PR2607	Profilo fermavetro	Glazing bead profile	8	LT/4-61	45	45
	Profilo fermavetro	Glazing bead profile	8	HT-156	45	45
Vetri		Glass unit				
	Vetrocamera	Double glazing	2	LT/4-96 x HT-168		
ACCESSORI		HARDWARE				
Cod.	Descrizione	Description	n°	Note/Notes		
AC290ANT	Kit squadrette di giunzione ante	Corner joint kit Sashes	2			
AC2895E.D	Kit squadrette di giunzione angoli per anta coassiale	Corner joint point kit for coaxial openable sash	opz.			
AC2895E.S	Kit squadrette di giunzione angoli per anta coassiale	Corner joint point kit for coaxial openable sash	opz.			
AG2992.EF	Rostro aggiuntivo	Additional hook bolt	opz.			
AG2989.EF	Kit prolungha aggiuntiva cremonese	Additional extension for cremonese bolt set	opz.			
AG2986 7E.xx	Kit alzante scorrevole	Lift and slide kit	1			
ACV__	Maniglione	Large handle	2			
AC2993P	Accessorio assiemaggio telaio	Frame assemblage accessory	var.			
AC1305G	Angolo vulcanizzato per GE1305S	Vulcanised corner gasket for GE1305S	6			
AC298TES.xx	Kit piastrine di giunzione telaio esterno	Kit of external frame junction plates	1			
CV5403I	Rondella in acciaio inox/epdm	Stainless steel/vulcanised epdm washer	var.			
AC2608	Clips fissaggio fermavetri	Clips for glazing bead	var.			
GUARNIZIONI*		GASKETS*				
Cod.	Descrizione	Description	n°	Dim.		
GU2036	Piattina adesiva morbida esterno vetro	Soft adhesive shim for external window	1	2xLT+8xHT		
GU2907TT	Guarnizione sotto vetro	Under glass gasket	1	2xLT+8xHT		
GP0095	Guarnizione interna vetro	Internal glass gasket	1	2xLT+8xHT		
GE2905S	Guarnizione superiore ante	Gasket for upper sash	2	LT		
GE1305S	Guarnizione perimetrale ante	Gasket for side sash	1	2xLT+4xHT		
GE1142	Guarnizione labirinto centrale	Gasket for central labyrinth	4	HT		
GU1387	Spazzolino verticale labirinto	Vertical labyrinth brush + adhesive	4	HT		
GU1147	Spazzolino tenuta superiore anta mobile	Upper sealing brush for sliding sash	2	LT		

* le dimensioni delle guarnizioni sono indicative e devono essere aumentate del 10% per adattamenti e ritiri del materiale nel tempo

* the gasket dimensions are indicative and have to be increased by 10% owing to adaptation and contraction of the material over time

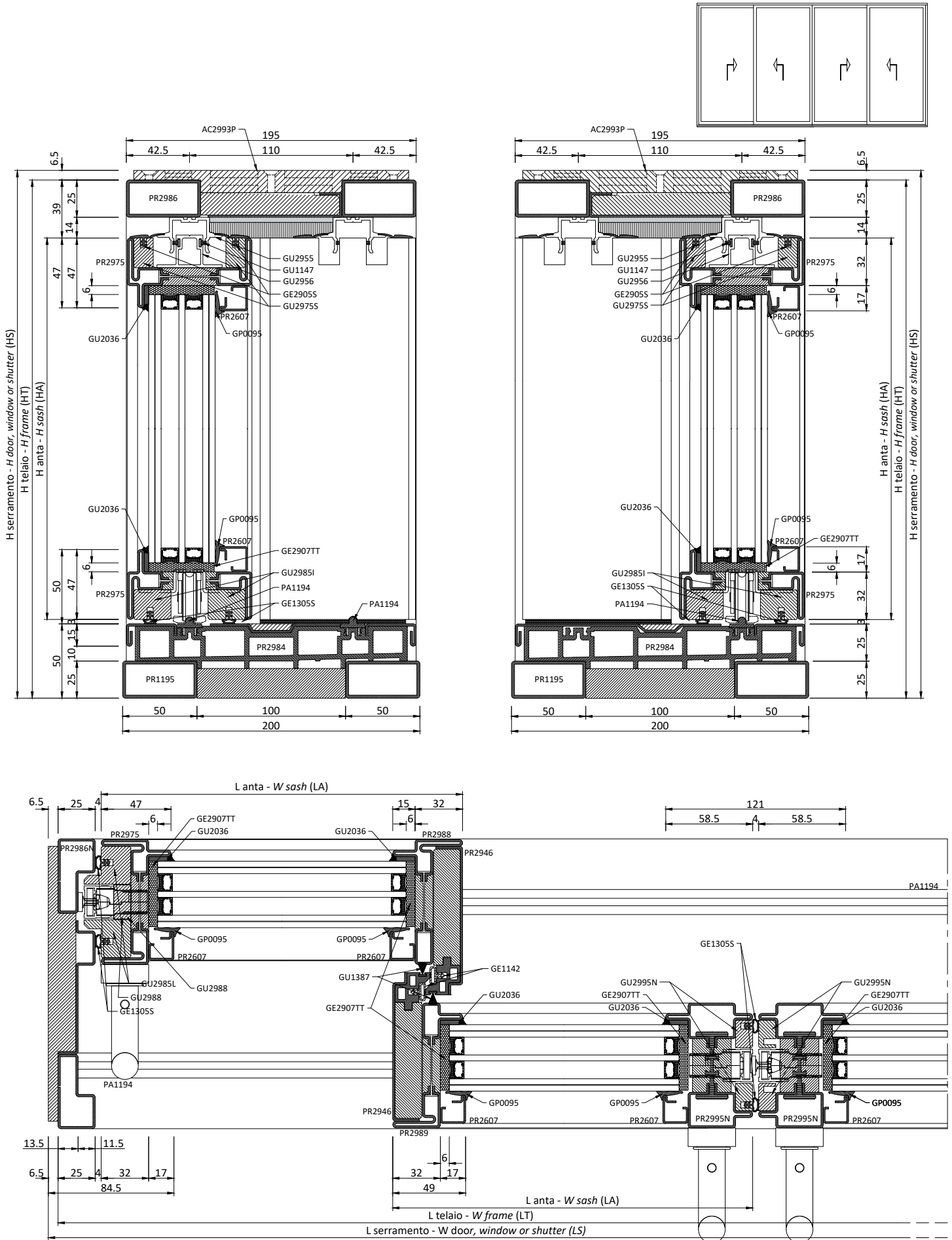

PROFILI		PROFILES			
Cod.	Descrizione	Description	n°	Dim.	Taglio/Cutting
Telaio		Frame			
PR2986	Profilo 50x25	Profile 50x25	2	LT	90 90
	Estruso centrale di unione	Central extrusion junction	2	LT/2	90 90
PR2986N	Profilo centrale a "C"	"C" profile	2	LT/2-2,5	90 90
	Profilo stampato	Metal sheet	4	LT-50	90 90
	Profilo centrale a "C"	C-shaped profile	2	LT-50	90 90
PR1195	Estruso centrale di unione	Lower frame - polyamide profile	2	LT-50	90 90
	Tubo 50x25 mm inox	50x25 mm stainless steel tube	2	LT	90 90
PR2984	Estruso centrale di unione	Central extrusion junction	1	LT	90 90
	Telaio base - copertina interna (Part. A)	Lower frame - internal cover (Detail A)	1	LT-27	90 90
	Telaio base - copertina centrale (Part. B)	Lower frame - central cover (Detail B)	1	LT/2-73	90 90
	Telaio base - copertina centrale (Part. B)	Lower frame - central cover (Detail B)	2	LT/4-33	90 90
	Telaio base - copertina esterna (Part. A)	Lower frame - external cover (Detail A)	1	LT-27	90 90
	Telaio base - profilo poliammide di supporto guide	Lower frame - polyamide profile of rails	1	LT-29	90 90
Guide		Rail			
GU2955	Profilo guida superiore ante	Upper rail of sliding sash	2	LT-27	90 90
GU2956	Pattino di scorrimento ante	Runner for sliding and fixed sash	4	LA-4	90 90
PA1194	Profilo guida inferiore	Lower profile	2	LT-27	90 90
Anta		Sash			
PR2975	Profilo zoccolo	Bottom rail profile	8	(LT-344)/4+94	45 45
	Profilo zoccolo	Bottom rail profile	4	HT-92	45 45
PR2995N	Profilo zoccolo	Bottom rail profile	2	HT-69	45 45
PR2988	Profilo a "T"	"T" profile	2	HT-92	45 45
PR2989	Profilo a "Z"	"Z" profile	2	HT-92	45 45
PR2946	Profilo labirinto centrale - anta mobile (Part. 1)	Central labyrinth profile - sliding sash (Detail 1)	4	HT-92	90 90
	Profilo labirinto centrale - anta mobile (Part. 2)	Central labyrinth profile - sliding sash (Detail 2)	4	HT-132	90 90
GU2985L	Profilo plastico porta guarnizione perimetrale verticale	Plastic door vertical profile perimeter gasket	4	HT-69	45 45
GU2985I	Profilo plastico porta guarnizione inferiore	Plastic door profile lower gasket	4	LT/4-17	45 90
GU2985I	Profilo plastico porta guarnizione inferiore	Plastic door profile lower gasket	4	LT/4-6	45 90
GU2975S	Profilo plastico porta guarnizione superiore	Plastic door profile upper gasket	4	LT/4-17	90 45
GU2975S	Profilo plastico porta guarnizione superiore	Plastic door profile upper gasket	4	LT/4-19	90 90
GU2995N	Profilo plastico porta guarnizione centrale	Plastic door profile central gasket	2	LT-92	90 45
GU2995N	Profilo plastico porta guarnizione centrale	Plastic door profile central gasket	2	LT-92	45 90
GU2988	Profilo plastico per spessore cremone	Plastic profile for cremone thickness	2	LT-249	90 90
Fermavetri		Glazing beads			
PR2607	Profilo fermavetro	Glazing bead profile	8	(LT-344)/4+30	45 45
	Profilo fermavetro	Glazing bead profile	8	HT-156	45 45
Vetri		Glass unit			
	Vetrocamera	Double glazing	4	(LT-344)/4+18x(HT-168)	
ACCESSORI		HARDWARE			
Cod.	Descrizione	Description	n°	Note/Notes	
AC290ANT	Kit squadrette di giunzione ante	Corner joint kit Sashes	4		
AG2992.AB	Rostro aggiuntivo	Additional hook bolt	opz.		
AG2986F.xx	Kit alzante scorrevole	Lift and slide kit	2		
ACV	Maniglione	Large handle	4		
AC2993P	Accessorio assiemaggio telaio	Frame assemblage accessory	var.		
AC1305G	Angolo vulcanizzato per GE1305S	Vulcanised corner gasket for GE1106S	8		
AC290TES	Squadretta di unione per telaio PR2986	Corner joint for frame PR2986	4		
CV5403I	Rondella in acciaio inox/epdm	Stainless steel/vulcanised epdm washer	var.		
AC2608	Clips fissaggio fermavetri	Clips for glazing bead	var.		
GUARNIZIONI*		GASKETS*			
Cod.	Descrizione	Description	n°	Dim.	
GU2036	Piattina adesiva morbida esterno vetro	Soft adhesive shim for external window	1	2xLT+8xHT	
GU2907TT	Guarnizione sotto vetro	Under glass gasket	1	2xLT+8xHT	
GP0095	Guarnizione interna vetro	Internal glass gasket	1	2xLT+8xHT	
GE2905S	Guarnizione superiore ante	Gasket for upper sash	8	LT/4	
GE1305S	Guarnizione perimetrale ante	Gasket for side sash	2	2xLT/2+6xHT	
GE1142	Guarnizione labirinto centrale	Gasket for central labyrinth	4	HT	
GU1387	Spazzolino verticale labirinto	Vertical labyrinth brush + adhesive	4	HT	
GU1147	Spazzolino tenuta superiore anta mobile	Upper sealing brush for sliding sash	8	LT/4+8	

* Le dimensioni delle guarnizioni sono indicative e devono essere aumentate del 10% per adattamenti e ritiri del materiale nel tempo

* the gasket dimensions are indicative and have to be increased by 10% owing to adaptation and contraction of the material over time

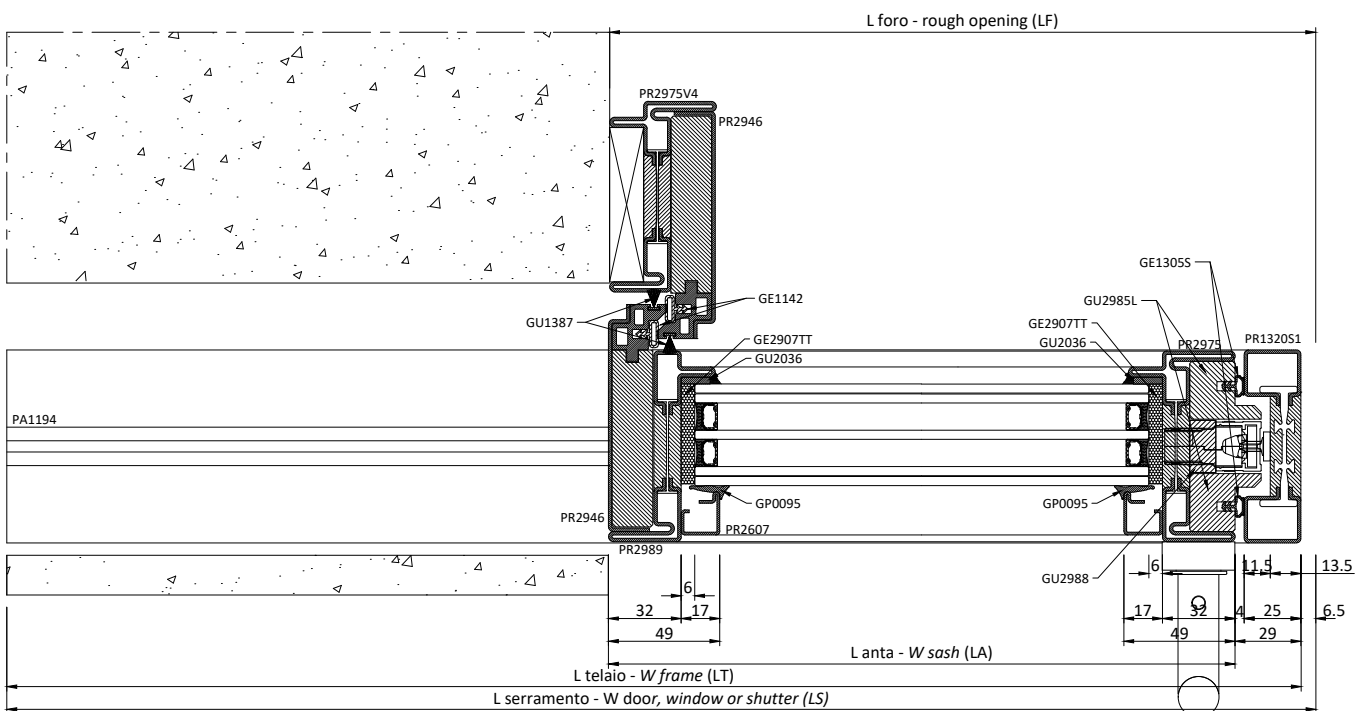
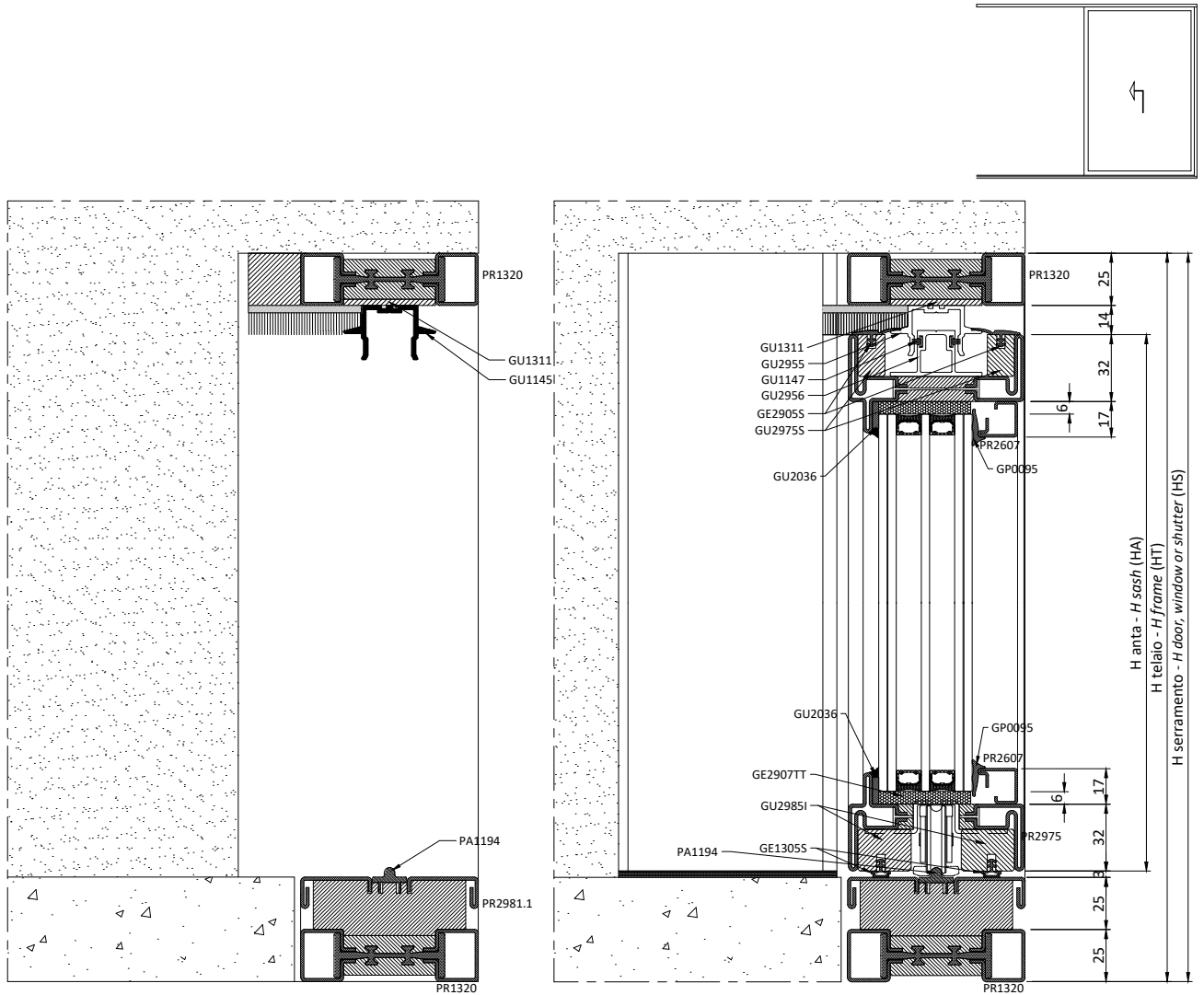

PROFILI		PROFILES			
Cod.	Descrizione	Description	n°	Dim.	Taglio/Cutting
Telaio		Frame			
PR1320	Profilo 85x25	Profile 85x25	2	LT	90 90
PR1320S1	Profilo 85x25	Profile 85x25	1	HT-50	90 90
PR2981.1	Telaio base - copertina interna (Part. A)	Lower frame - internal cover (Detail A)	1	LT/2-10	90 90
	Telaio base - copertina esterna (Part. A)	Lower frame - external cover (Detail A)	1	LT/2-92	90 90
	Telaio base - profilo poliammide di supporto	Lower frame - polyamide profile of rails	1	LT-15	90 90
Guide		Rail			
GU2955	Profilo guida superiore anta mobile	Upper rail of sliding sash	1	LT-14	90 90
GU2956	Pattino di scorrimento anta mobile e fissa	Runner for sliding and fixed sash	2	LT/2-56	90 90
PA1194	Profilo guida inferiore	Lower profile	1	LT-14	90 90
Anta		Sash			
PR2975	Profilo zoccolo	Bottom rail profile	2	LT/2-52	45 45
	Profilo zoccolo	Bottom rail profile	1	HT-92	45 45
PR2989	Profilo a "Z"	"Z" profile	1	HT-92	45 45
PR2975V4	Profilo zoccolo	Bottom rail profile	1	HT-53	90 90
PR2946	Profilo labirinto centrale - anta mobile (Part. 1)	Central labyrinth profile - sliding sash (Detail 1)	1	HT-92	90 90
	Profilo labirinto centrale - anta mobile (Part. 2)	Central labyrinth profile - sliding sash (Detail 2)	1	HT-132	90 90
	Profilo labirinto centrale - fisso (Part. 1)	Central labyrinth profile - fixed sash (Detail 1)	1	HT-53	90 90
	Profilo labirinto centrale - fisso (Part. 2)	Central labyrinth profile - fixed (Detail 2)	1	HT-92	90 90
GU2985L	Profilo plastico porta guarnizione perimetrale verticale	Plastic door vertical profile perimeter gasket	2	HT-69	45 45
GU2985I	Profilo plastico porta guarnizione perimetrale	Plastic door profile perimeter gasket	2	LT/2-72	45 90
GU2975S	Profilo plastico porta guarnizione superiore	Plastic door profile upper gasket	2	LT/2-72	90 45
GU2988	Profilo plastico fissaggio cremonese	Plastic profile for cremone bolt fixing	1	HT-249	90 90
GU1311	Profilo plastico di compensazione	Plastic compensation profile	1	LT	90 90
Fermavetri		Glazing beads			
PR2607	Profilo fermavetro	Glazing bead profile	2	LT/2-116	45 45
	Profilo fermavetro	Glazing bead profile	2	HT-156	45 45
Vetri		Glass unit			
	Vetrocamera	Double glazing	2	LT/2-128 x HT-168	
ACCESSORI		HARDWARE			
Cod.	Descrizione	Description	n°	Note/Notes	
AC290ANT	Kit squadrette di giunzione ante	Corner joint kit Sashes	1		
AG2992.AB	Rostro aggiuntivo	Additional hook bolt	opz.		
AG2989.AB	Kit prolunga aggiuntiva cremonese	Additional extension kit for cremone bolt set	opz.		
AG2986 7S1.xx	Kit alzante scorrevole	Lift and slide kit	1		
ACV__	Maniglione	Large handle	1		
AC1305G	Angolo vulcanizzato per GE1305S	Vulcanised corner gasket for GE1305S	2		
AC298TSC.xx	Kit piastrine di giunzione telaio esterno	Kit of external frame junction plates	1		
AC2608	Clips fissaggio fermavetri	Clips for glazing bead	var.		
GUARNIZIONI*		GASKETS*			
Cod.	Descrizione	Description	n°	Dim.	
GU2036	Piattina adesiva morbida esterno vetro	Soft adhesive shim for external window	1	LT+2xHT	
GU2907T	Guarnizione sotto vetro	Under glass gasket	1	LT+2xHT	
GPO095	Guarnizione interna vetro	Internal glass gasket	1	LT+2xHT	
GE2905S	Guarnizione superiore ante	Gasket for upper sash	1	LT	
GE1305S	Guarnizione perimetrale ante	Gasket for side sash	1	LT+2xHT	
GE1142	Guarnizione labirinto centrale	Gasket for central labyrinth	2	HT	
GU1387	Spazzolino verticale labirinto	Vertical labyrinth brush + adhesive	2	HT	
GU1147	Spazzolino tenuta superiore anta mobile	Upper sealing brush for sliding sash	1	LT	

* Le dimensioni delle guarnizioni sono indicative e devono essere aumentate del 10% per adattamenti e ritiri del materiale nel tempo

* the gasket dimensions are indicative and have to be increased by 10% owing to adaptation and contraction of the material over time

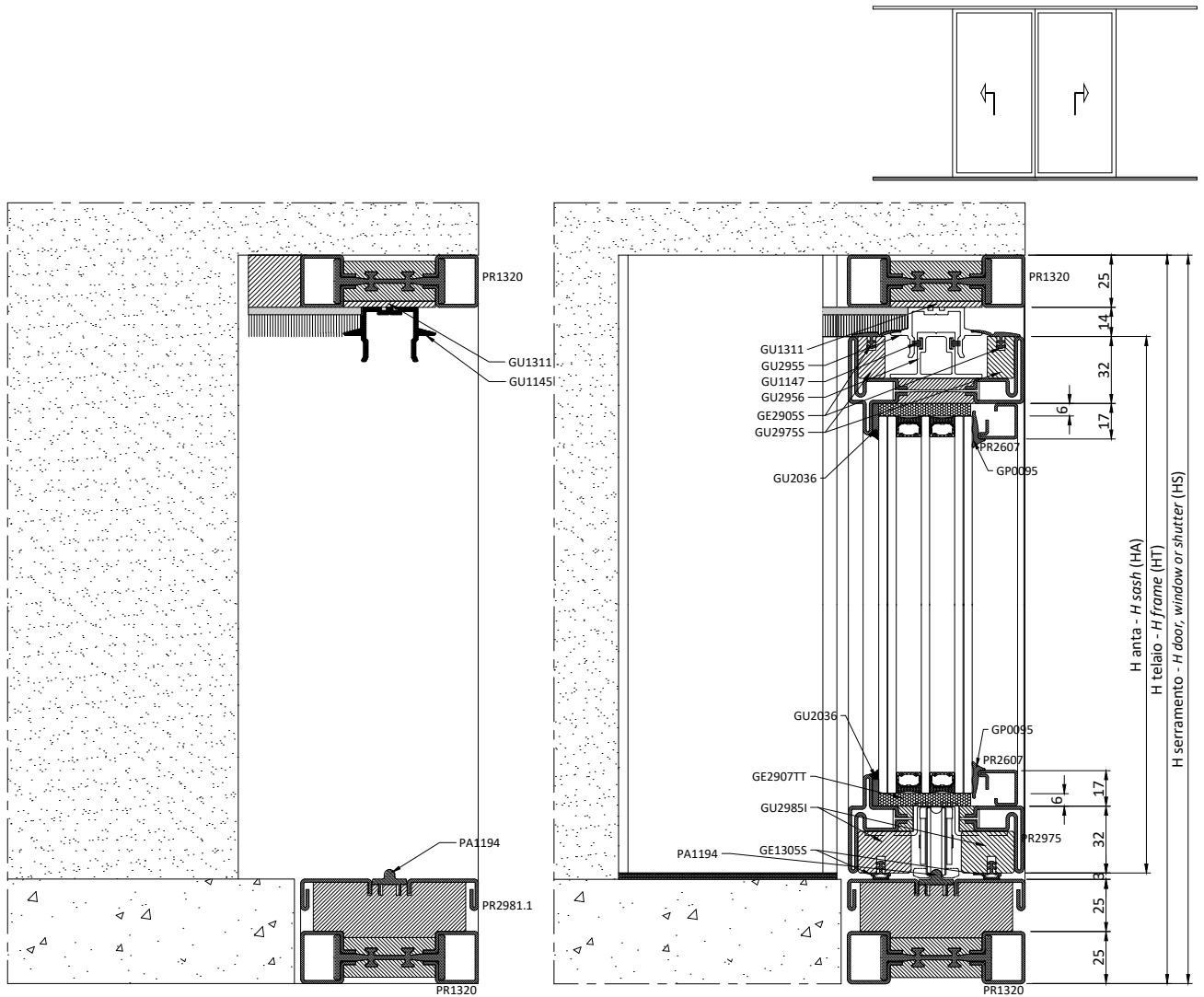

L foro - rough opening (LF)

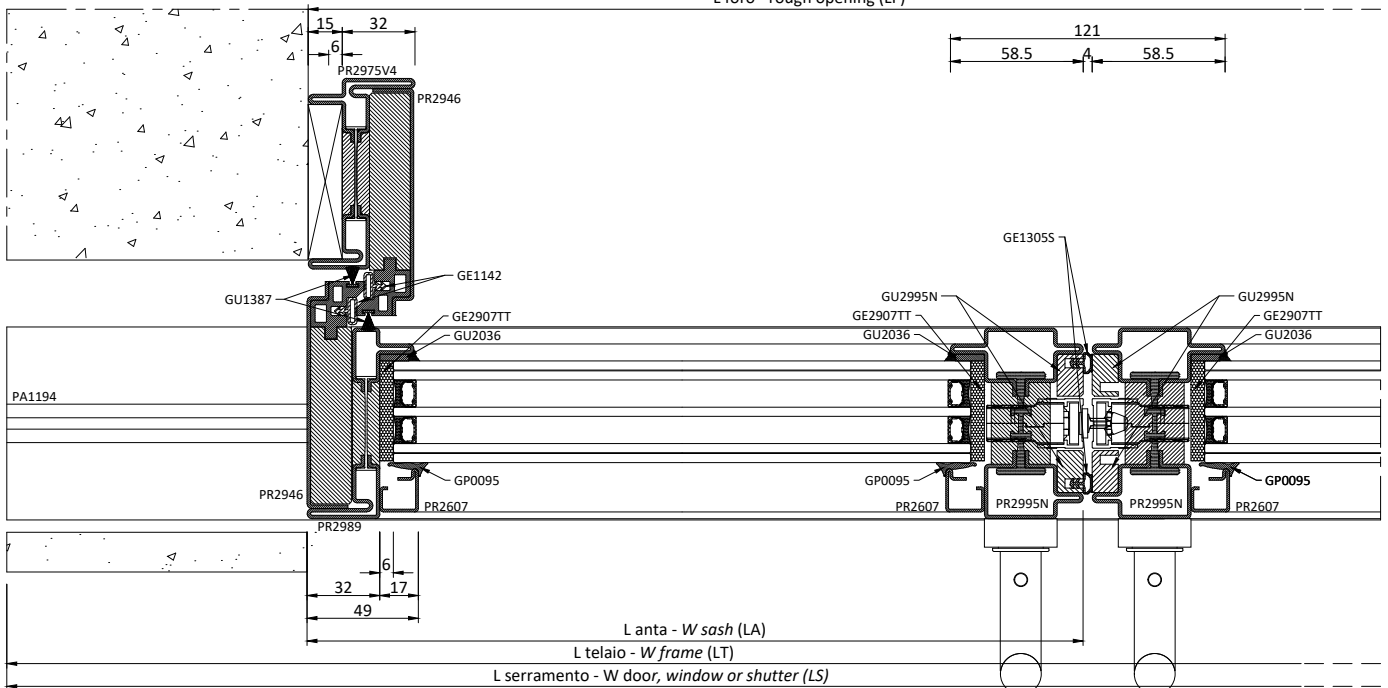

PROFILI		PROFILES			
Cod.	Descrizione	Description	n°	Dim.	Taglio/Cutting
Telaio		Frame			
PR1320	Profilo 85x25	Profile 85x25	2	LT	90 90
PR2981.1	Telaio base - copertina interna (Part. A)	Lower frame - internal cover (Detail A)	1	LT/2+23	90 90
	Telaio base - copertina esterna (Part. A)	Lower frame - external cover (Detail A)	1	LT/2-141	90 90
	Telaio base - profilo poliammide di supporto	Lower frame - polyamide profile of rails	1	LT	90 90
Guide		Rail			
GU2955	Profilo guida superiore anta mobile	Upper rail of sliding sash	1	LT	90 90
GU2956	Pattino di scorrimento anta mobile e fissa	Runner for sliding and fixed sash	2	LA-4	90 90
PA1194	Profilo guida inferiore	Lower profile	1	LT	90 90
Anta		Sash			
PR2975	Profilo zoccolo	Bottom rail profile	4	LT/4-50	45 45
PR2995N	Profilo zoccolo	Bottom rail profile	2	HT-69	45 45
PR2989	Profilo a "Z"	"Z" profile	2	HT-92	45 45
PR2975V4	Profilo zoccolo	Bottom rail profile	2	HT-53	90 90
PR2946	Profilo labirinto centrale - anta mobile (Part. 1)	Central labyrinth profile - sliding sash (Detail 1)	2	HT-92	90 90
	Profilo labirinto centrale - anta mobile (Part. 2)	Central labyrinth profile - sliding sash (Detail 2)	2	HT-132	90 90
	Profilo labirinto centrale - fisso (Part. 1)	Central labyrinth profile - fixed sash (Detail 1)	2	HT-53	90 90
	Profilo labirinto centrale - fisso (Part. 2)	Central labyrinth profile - fixed (Detail 2)	2	HT-92	90 90
GU2985I	Profilo plastico porta guarnizione perimetrale	Plastic door profile perimeter gasket	4	LT/4-57	45 90
GU2975S	Profilo plastico porta guarnizione superiore	Plastic door profile upper gasket	4	LT/4-70	90 45
GU2995N	Profilo plastico fissaggio cremonese	Plastic profile for cremona bolt fixing	2	HT-92	90 45
GU2995N	Profilo plastico fissaggio cremonese	Plastic profile for cremona bolt fixing	2	HT-92	45 90
GU1311	Profilo plastico di compensazione	Plastic compensation profile	1	LT	90 90
Fermavetri		Glazing beads			
PR2607	Profilo fermavetro	Glazing bead profile	2	LT/4-114	45 45
	Profilo fermavetro	Glazing bead profile	2	HT-156	45 45
Vetri		Glass unit			
	Vetrocamera	Double glazing	2	LT/2-126 x HT-168	
ACCESSORI		HARDWARE			
Cod.	Descrizione	Description	n°	Note/Notes	
AC290ANT	Kit squadrette di giunzione ante	Corner joint kit Sashes	2		
AG2992.EF	Rostro aggiuntivo	Additional hook bolt	opz.		
AG2989.EF	Kit prolunga aggiuntiva cremonese	Additional extension kit for cremona bolt set	opz.		
AG2986 751.xx	Kit alzante scorrevole	Lift and slide kit	1		
ACV__	Maniglione	Large handle	1		
AC1305G	Angolo vulcanizzato per GE1305S	Vulcanised corner gasket for GE1305S	2		
AC2608	Clips fissaggio fermavetri	Clips for glazing bead	var.		
GUARNIZIONI*		GASKETS*			
Cod.	Descrizione	Description	n°	Dim.	
GU2036	Piattina adesiva morbida esterno vetro	Soft adhesive shim for external window	1	LT+4xHT	
GU2907TT	Guarnizione sotto vetro	Under glass gasket	1	LT+4xHT	
GPO095	Guarnizione interna vetro	Internal glass gasket	1	LT+4xHT	
GE2905S	Guarnizione superiore ante	Gasket for upper sash	1	LT	
GE1305S	Guarnizione perimetrale ante	Gasket for side sash	1	LT+2xHT	
GE1142	Guarnizione labirinto centrale	Gasket for central labyrinth	4	HT	
GU1387	Spazzolino verticale labirinto	Vertical labyrinth brush + adhesive	4	HT	
GU1147	Spazzolino tenuta superiore anta mobile	Upper sealing brush for sliding sash	1	LT	

* le dimensioni delle guarnizioni sono indicative e devono essere aumentate del 10% per adattamenti e ritiri del materiale nel tempo

* the gasket dimensions are indicative and have to be increased by 10% owing to adaptation and contraction of the material over time

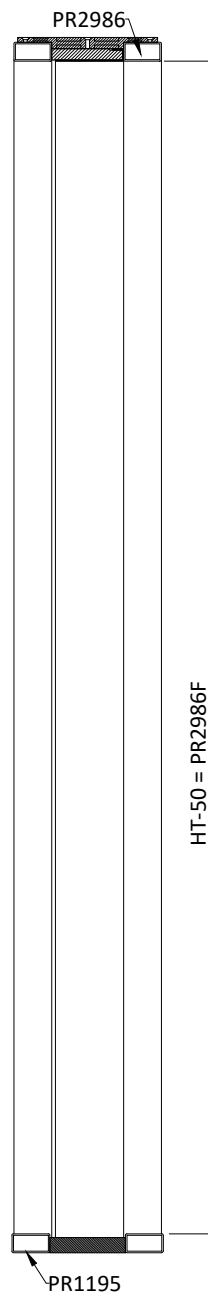
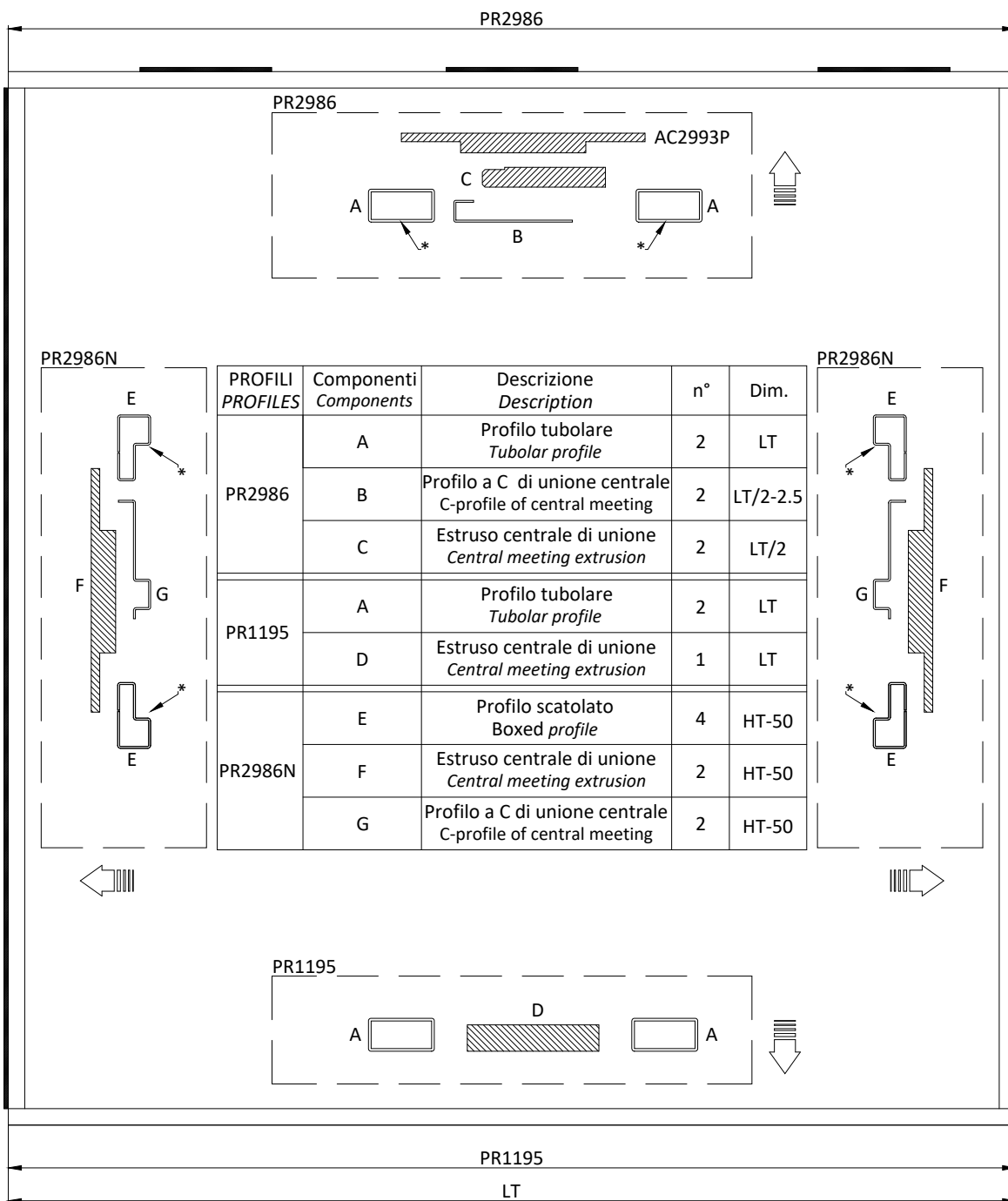
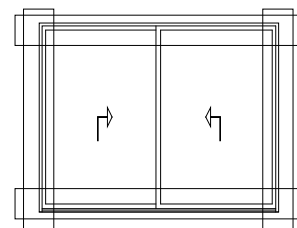
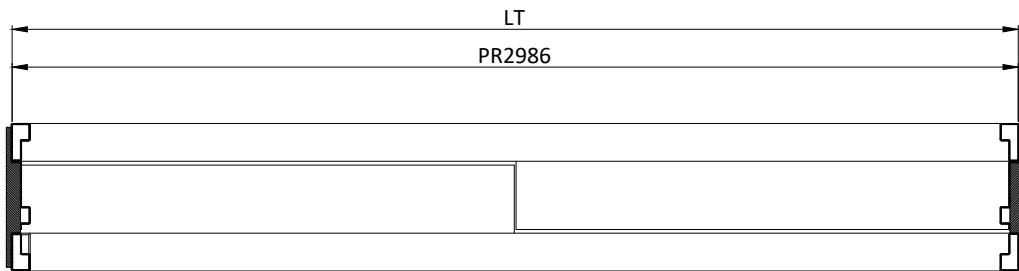

* ATTENZIONE forare il profilo prima dell'assieme per il fissaggio della guida GU2955
* ATTENTION perforate the profile before assembling to attach the GU2955 rail

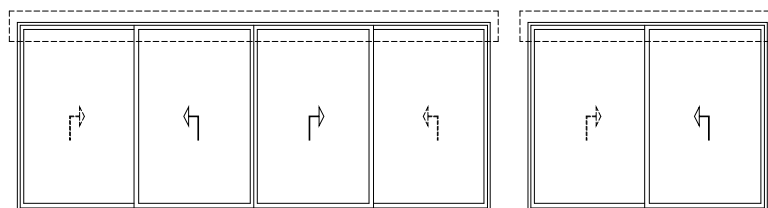

Prima di assemblare il telaio esterno forare $\varnothing 4$ mm il profilo superiore per fissaggio guida GU2955
 Before assembling the frame make a $\varnothing 4$ mm hole in the upper profile to attach the GU2955 rail

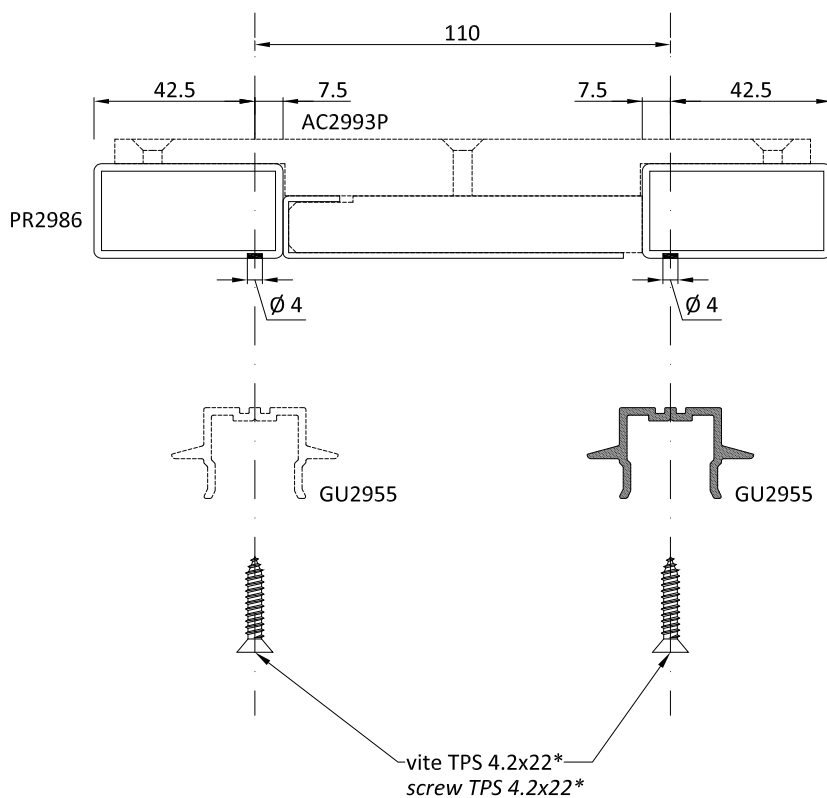

Il passo di foratura viene definito nelle singole schede di applicazione guida GU2955 delle specifiche tipologie realizzabili
 The spacing of the drilled holes is described in the individual rail GU2955 application sheets for the specific typologies possible

* viti TPS 4.2x22 non comprese
 * screws TPS 4.2x22 not supplied

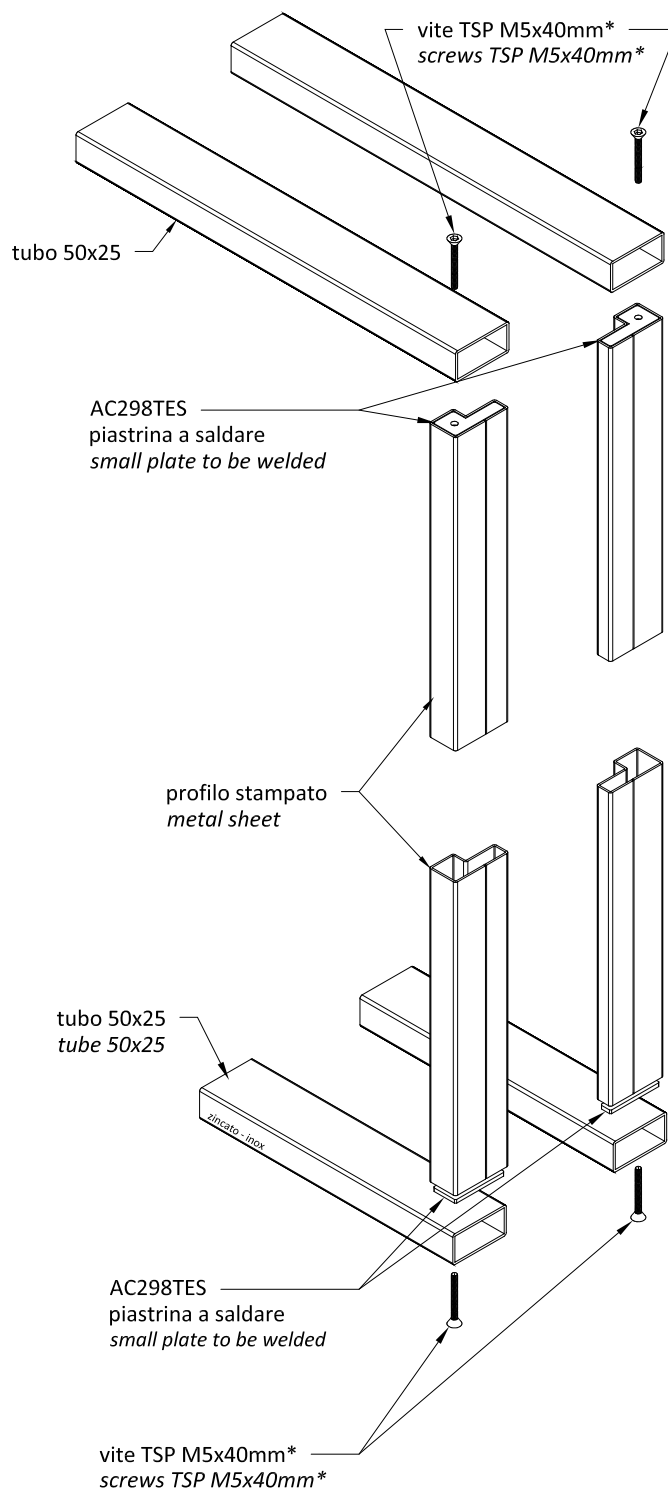
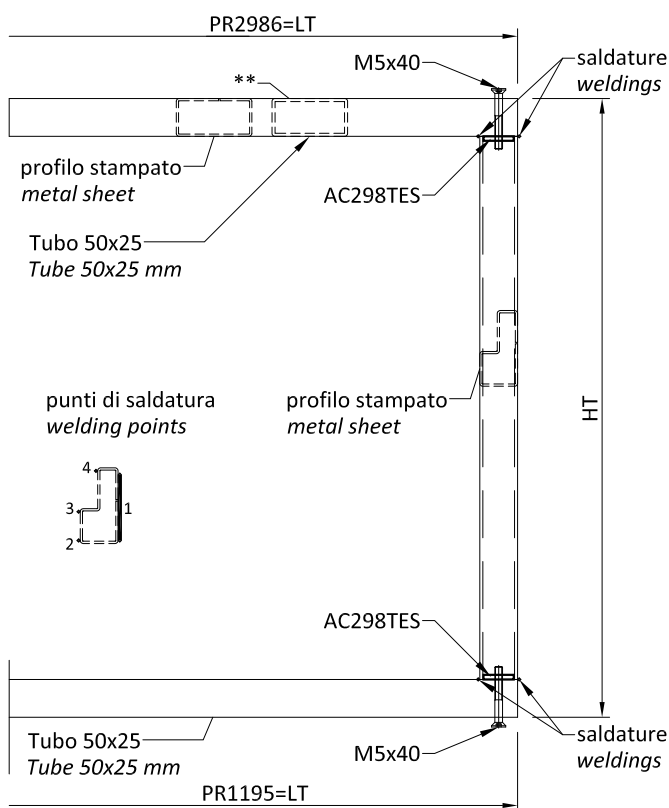
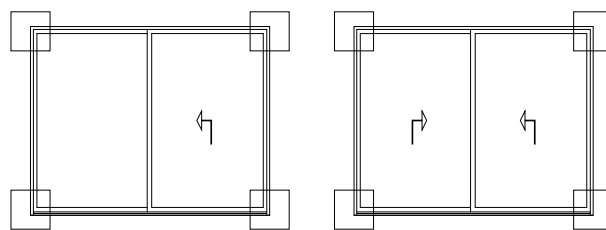
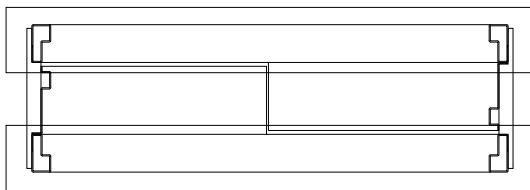

Procedura di assiemaggio telaio | *Frame assembly procedure:*

- saldare le piastrine al montante verticale
weld the plates to the upright
- intestare il montante verticale ed orizzontale con viti M5x40
end the vertical and horizontal upright fixed with M5x40 screws
- saldare in continuo le parti a contatto esterne (1) e saldare a punti le parti interne (2-3-4)
continuous welding of the areas in contact with exterior welding points (1) of the internal areas (2-3-4)
- sigillare internamente ed esternamente
seal off inside and outside

* viti TPS M5x40 non comprese | *screws TPS M5x30 not included*

**ATTENZIONE forare il profilo prima dell'assiemaggio per il fissaggio della guida GU2955

**ATTENTION perforate the profile before assembling to attach the GU2955 rail

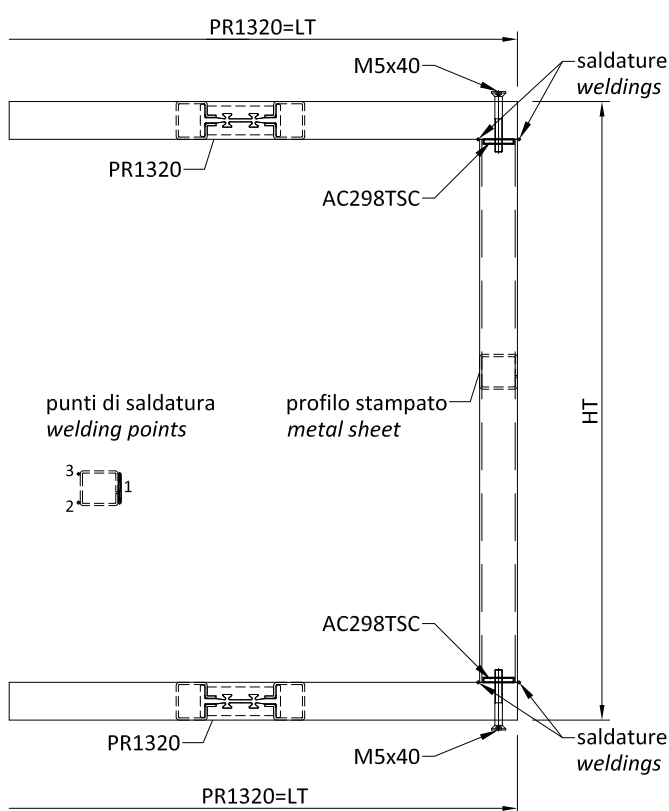
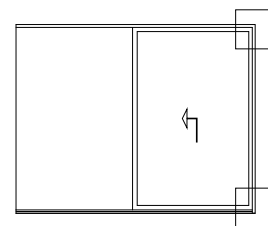
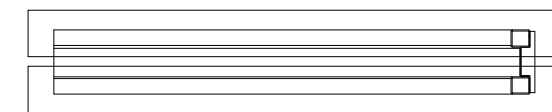

Procedura di assiemaggio telaio | *Frame assembly procedure:*

- saldare le piastrine al montante verticale
weld the plates to the upright
- intestare il montante verticale ed orizzontale con viti M5x40
end the vertical and horizontal upright fixed with M5x40 screws
- saldare in continuo le parti a contatto esterne (1) e saldare a punti le parti interne (2-3)
continuous welding of the areas in contact with exterior welding points (1) of the internal areas (2-3)
- sigillare internamente ed esternamente
seal off inside and outside

vite TSP M5x40mm*
screws TSP M5x40mm*

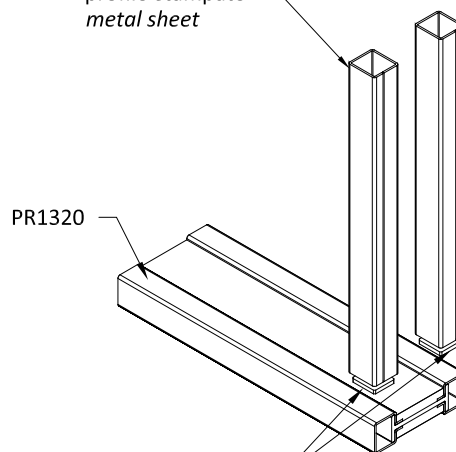
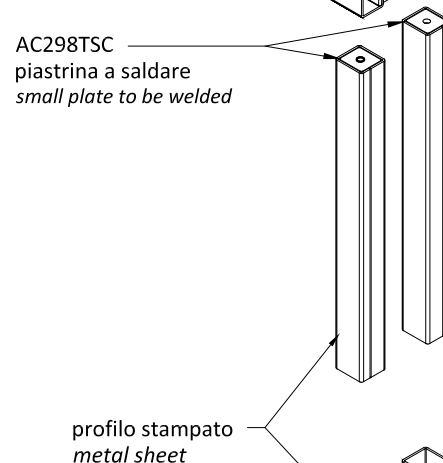
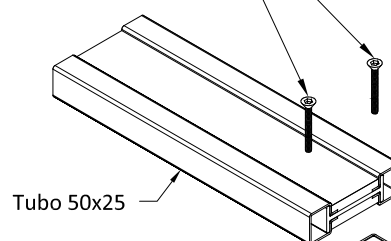

AC298TSC
piastrina a saldare
small plate to be welded

vite TSP M5x40mm*
screws TSP M5x40mm*

* viti TPS M5x40 non comprese | *screws TPS M5x30 not included*

**ATTENZIONE forare il profilo prima dell'assiemaggio per il fissaggio della guida GU2955

**ATTENTION perforate the profile before assembling to attach the GU2955 rail

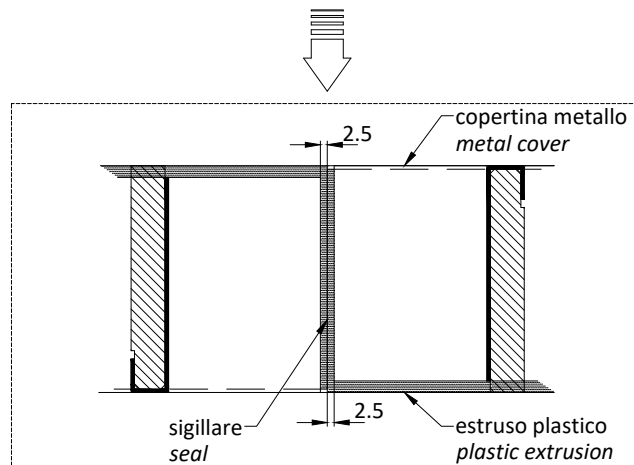
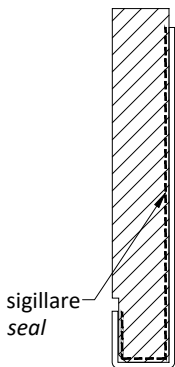
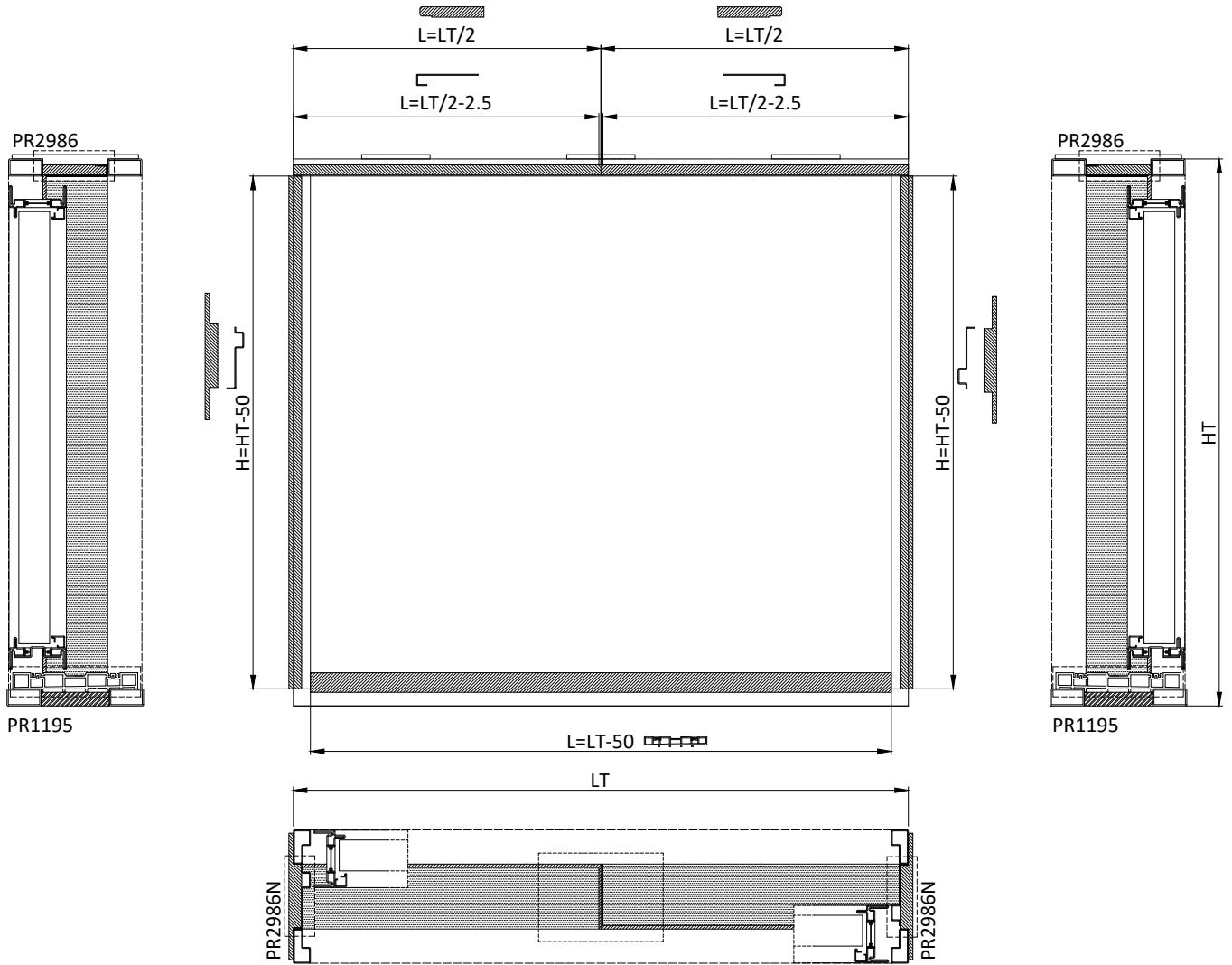
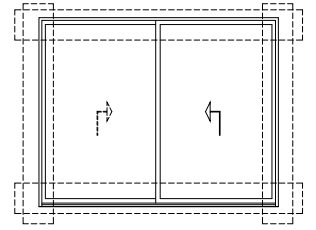
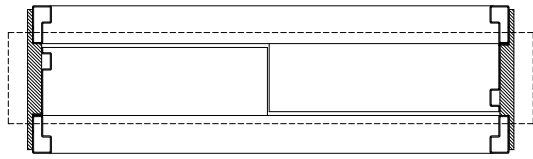

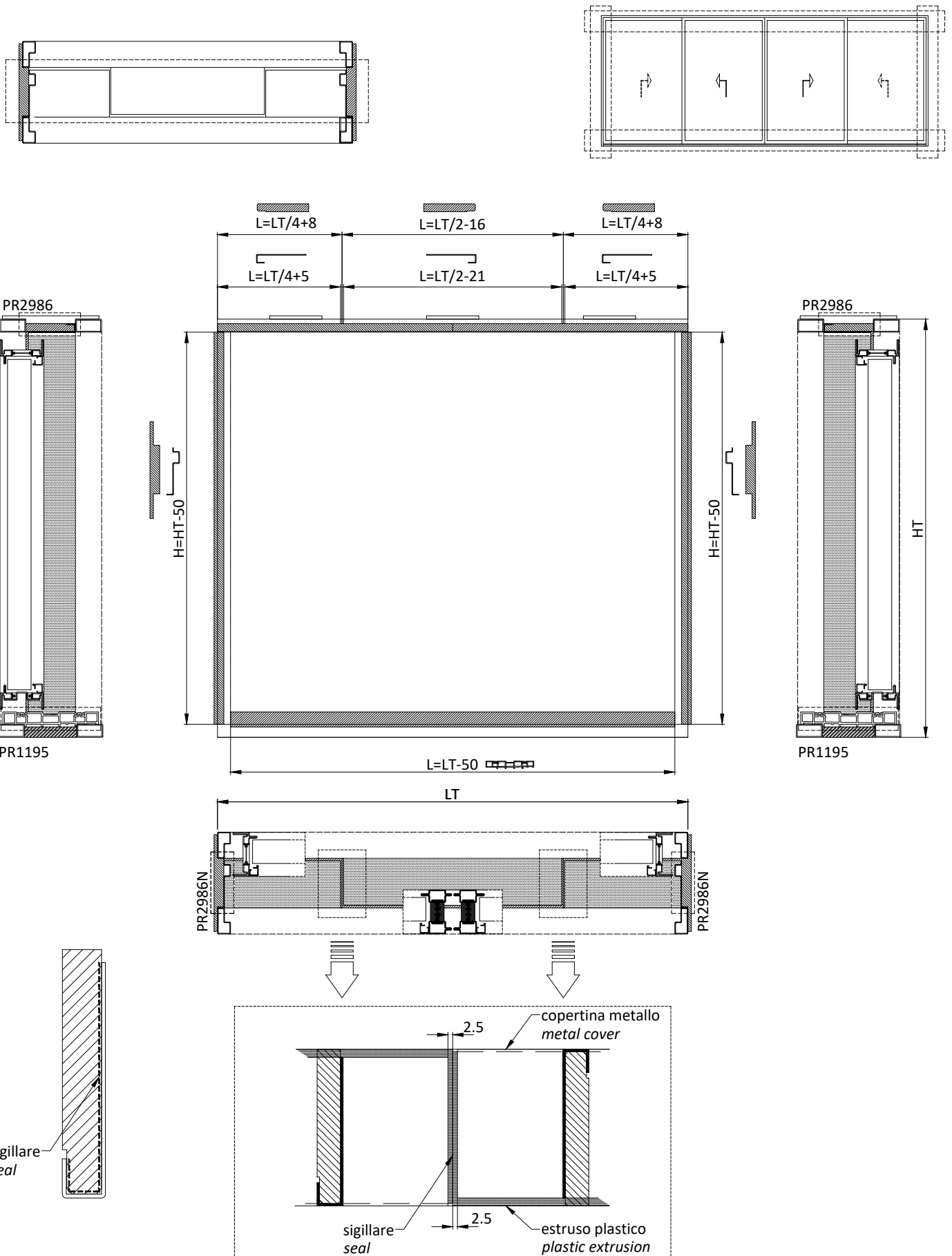

****DA VERIFICARE CON LE DIMENSIONI DELL'ACCESSORIO CONSEGNAO
TO VERIFY WITH DIMENSIONS OF THE DELIVERED ACCESSORY

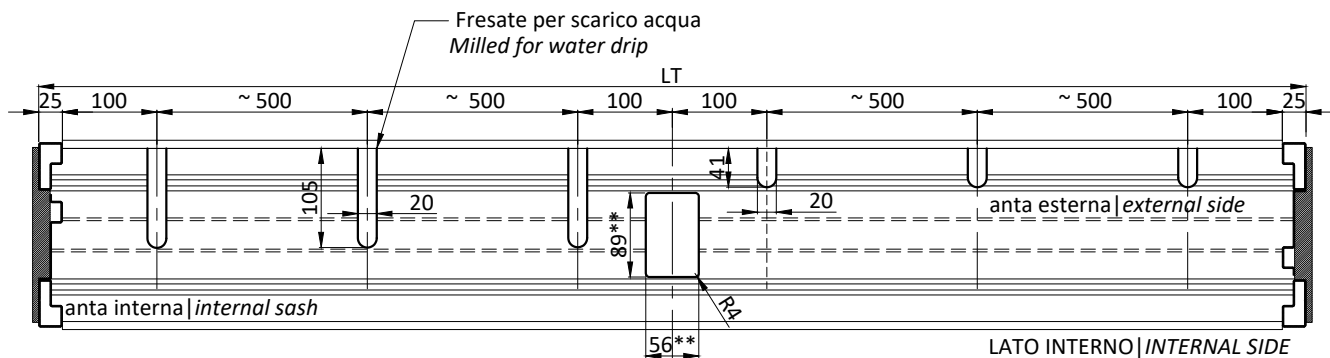
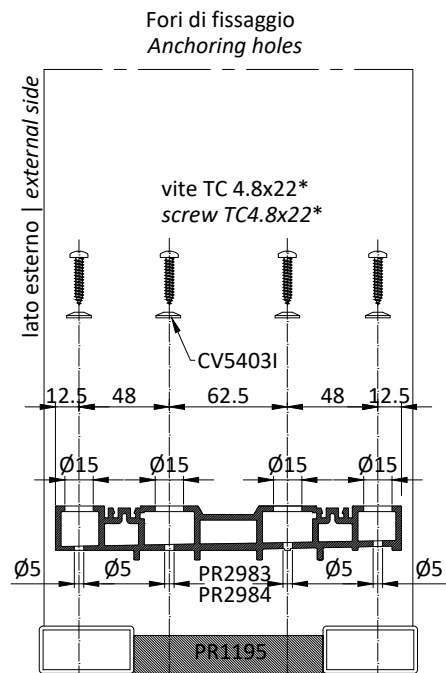
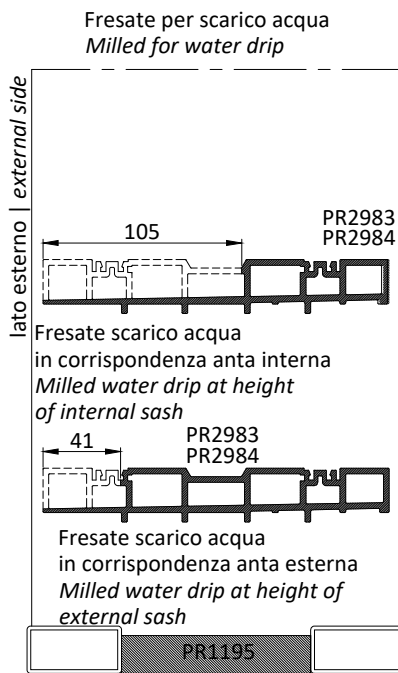
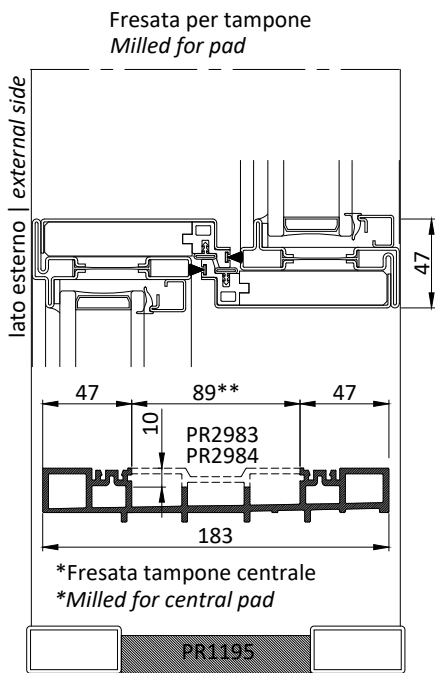
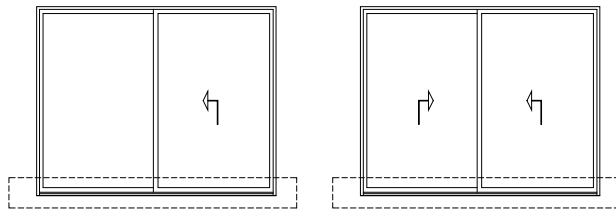

Fori di fissaggio PR2983-PR2984 al PR1195
Anchoring holes PR2983-PR2984 to PR1195

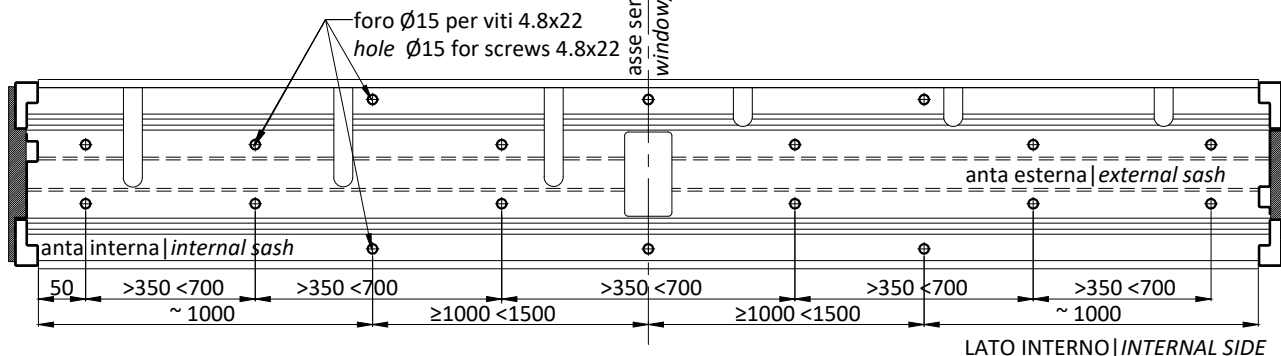

* viti TPS-TC 4.8x22 non comprese
*screws TPS-TC 4.8x22 not supplied

****DA VERIFICARE CON LE DIMENSIONI DELL'ACCESSORIO CONSEGNA TO
TO VERIFY WITH DIMENSIONS OF THE DELIVERED ACCESSORY

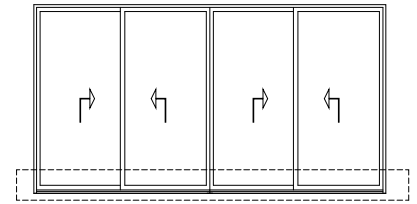
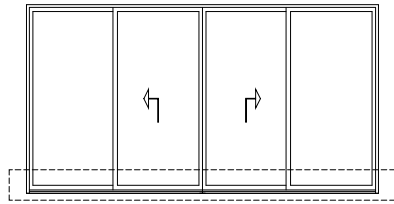

Fresata per tampone
Milled for pad

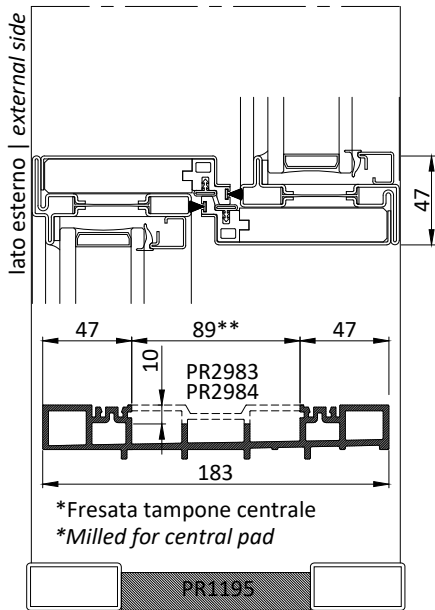

Fresate per scarico acqua
Milled for water drip

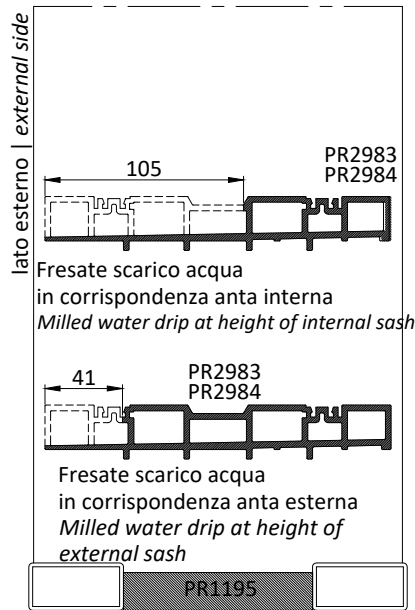

Fori di fissaggio
Anchoring holes

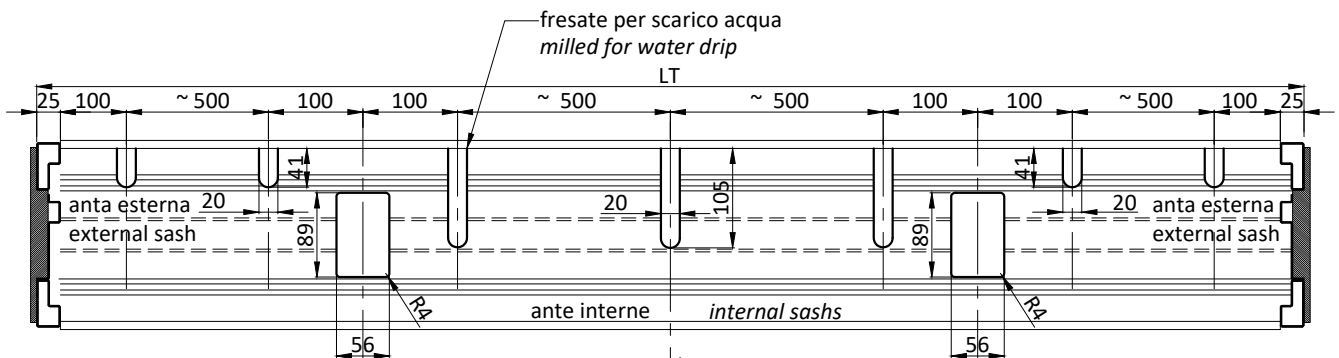
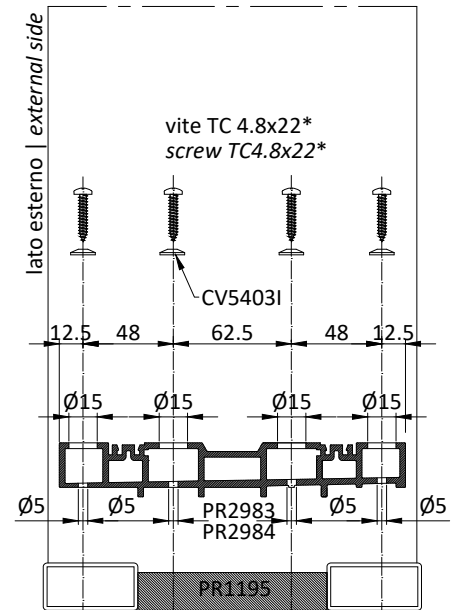

Fori di fissaggio
PR2983-PR2984 al PR1195
Fixing holes
PR2983-PR2984 to PR1195

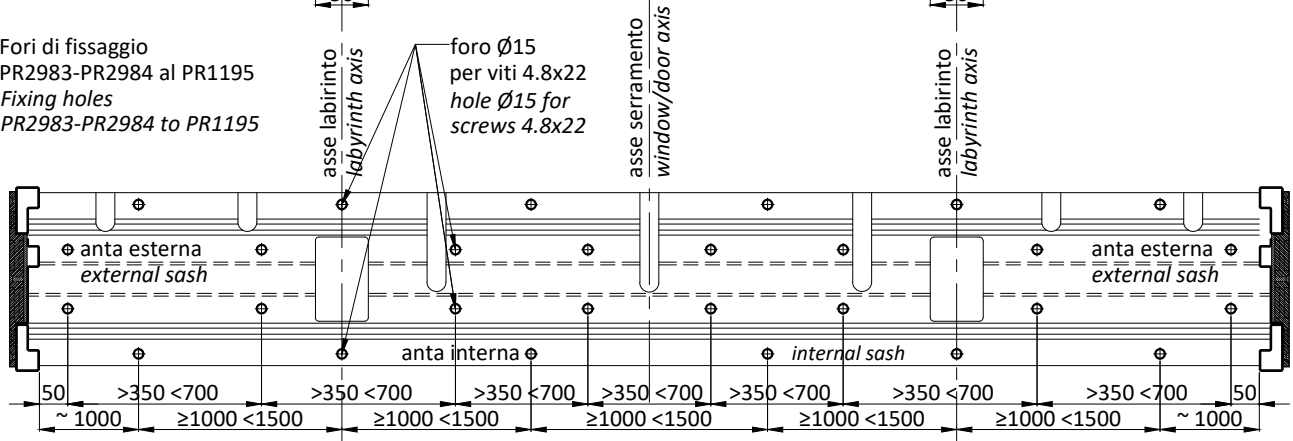

* viti TPS-TC 4.8x22 non comprese
* screws TPS-TC 4.8x22 not supplied

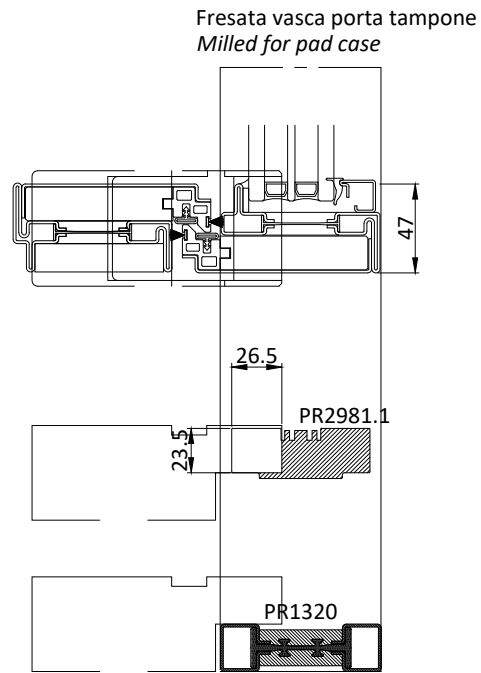
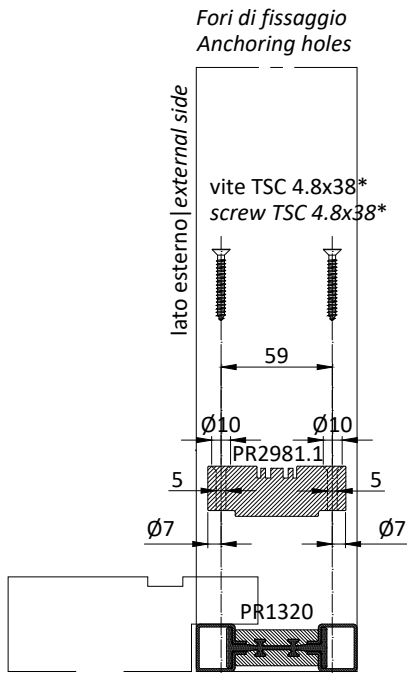
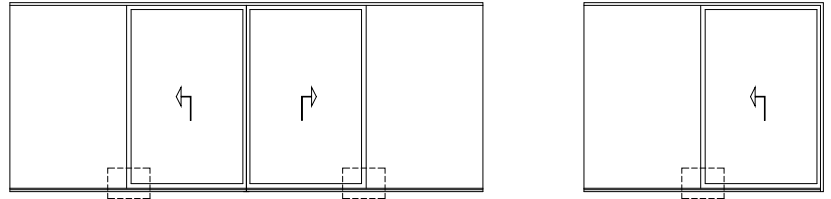

Porta vaschetta tampone
Pad case

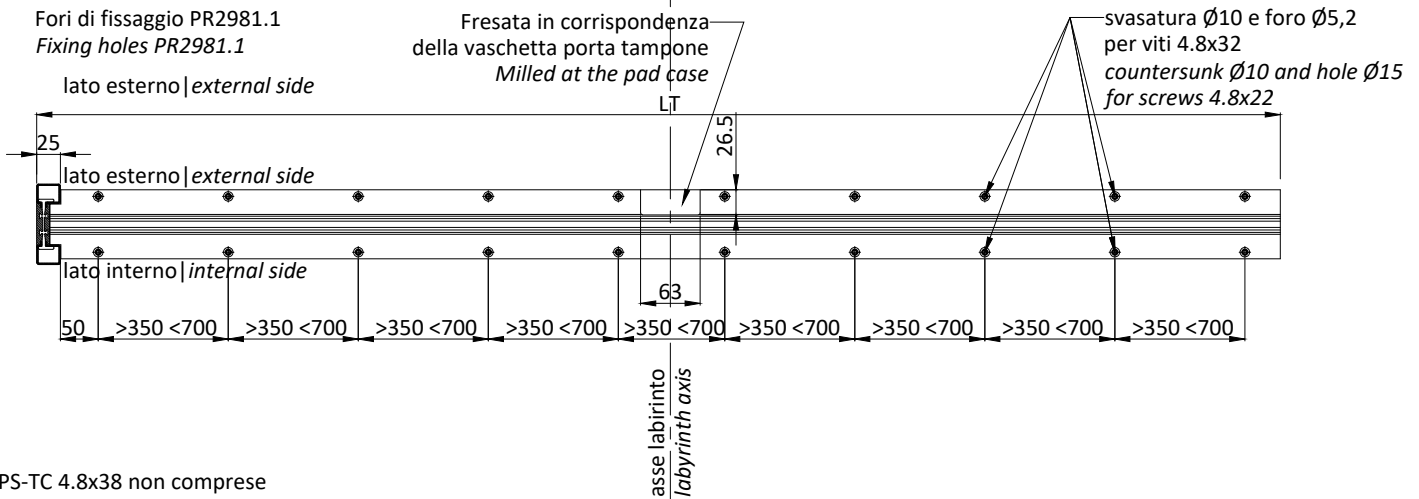
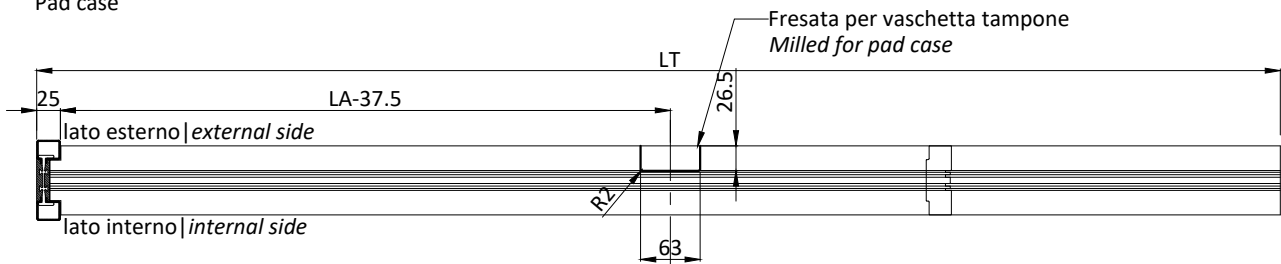

* viti TPS-TC 4.8x38 non comprese
* screws TPS-TC 4.8x38 not supplied

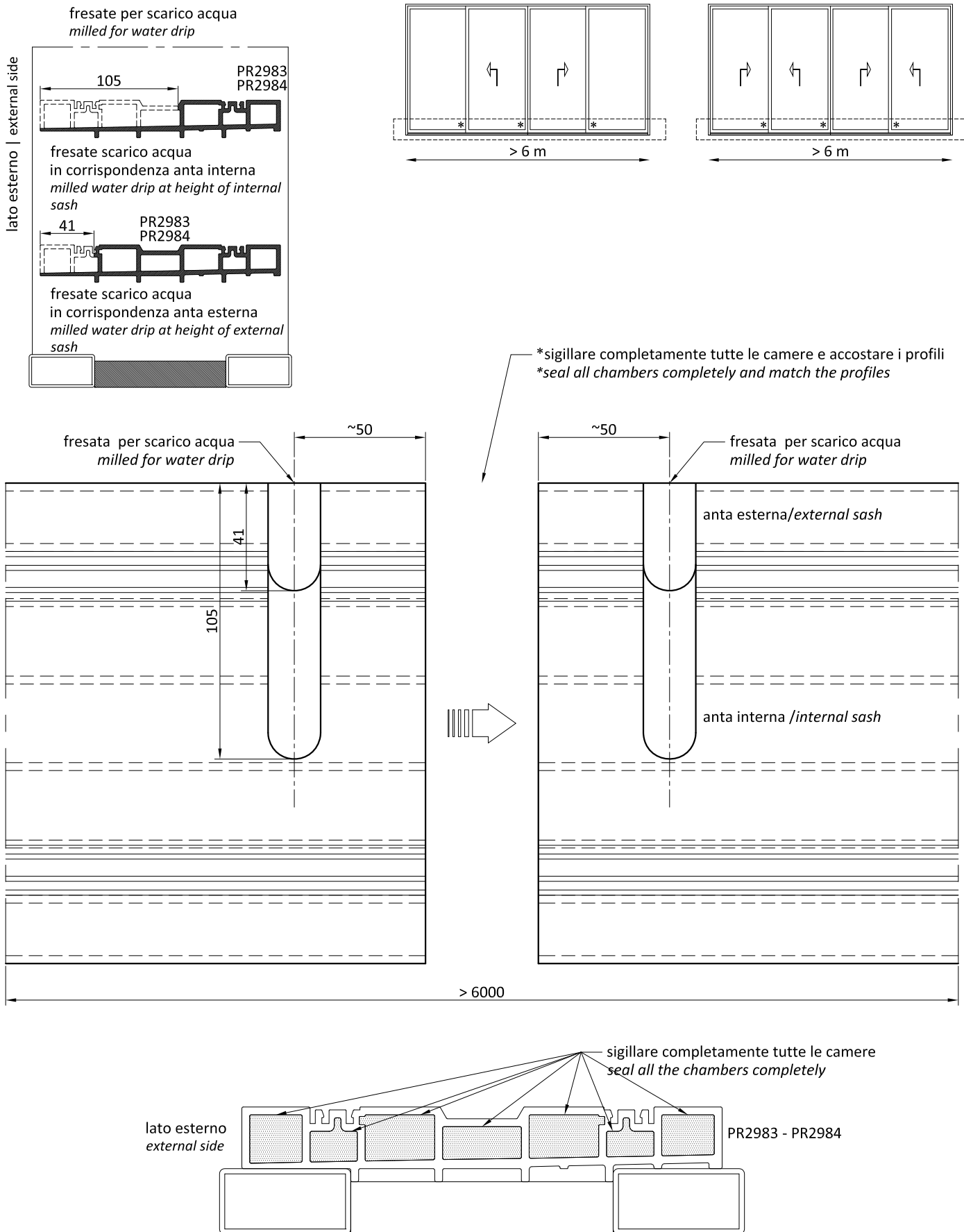

* VIETATA la giunzione in asse del labirinto dove viene eseguita la fresatura per il tampone ed in asse centrale del serramento dove si incontrano le due ante interne ed è realizzato lo scarico acqua centrale
*FORBIDDEN the junction on the axis of the labyrinth where milling is carried out for the pad and on the central axis of the door/window where the two internal sashes meet and the main water drip is located

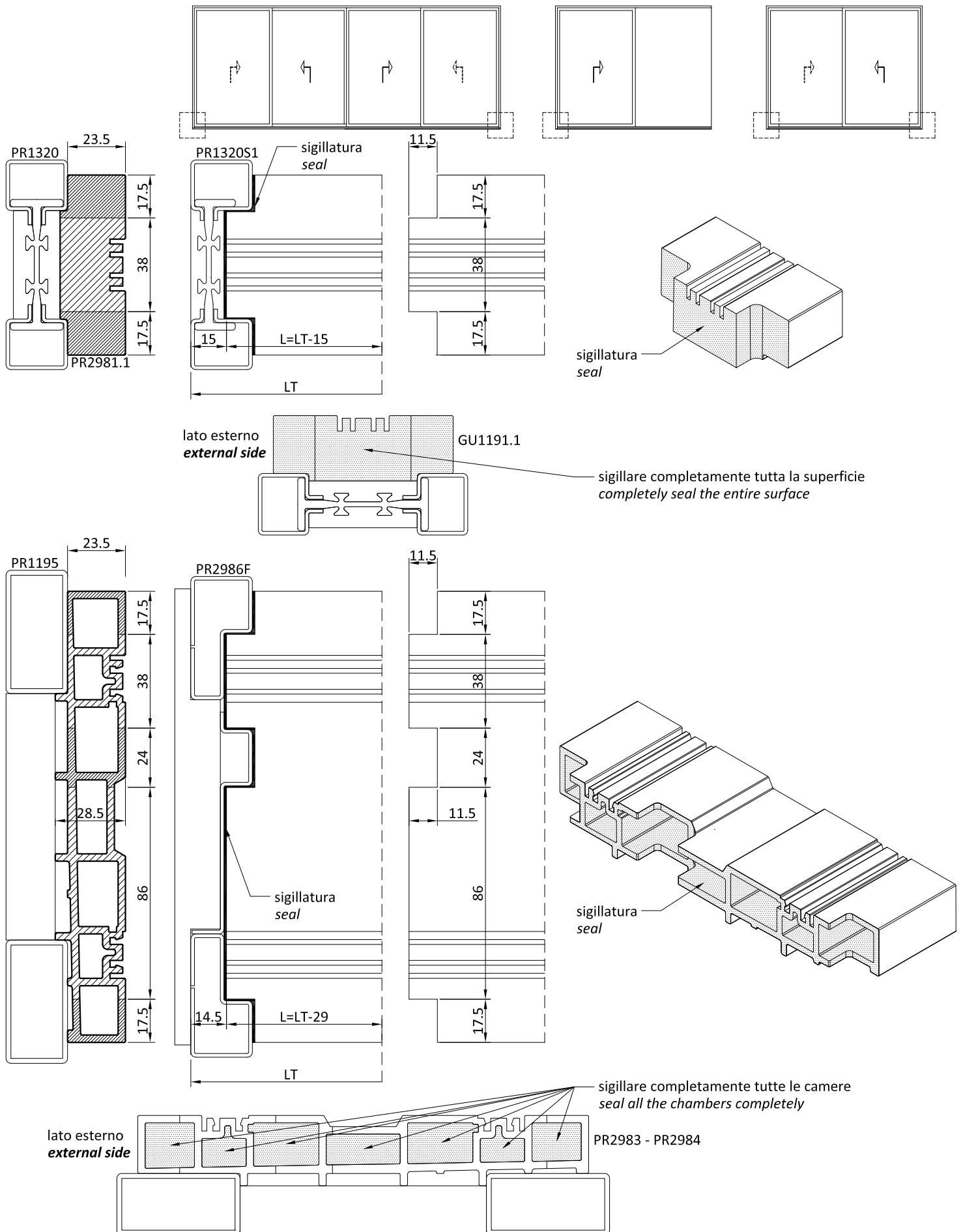

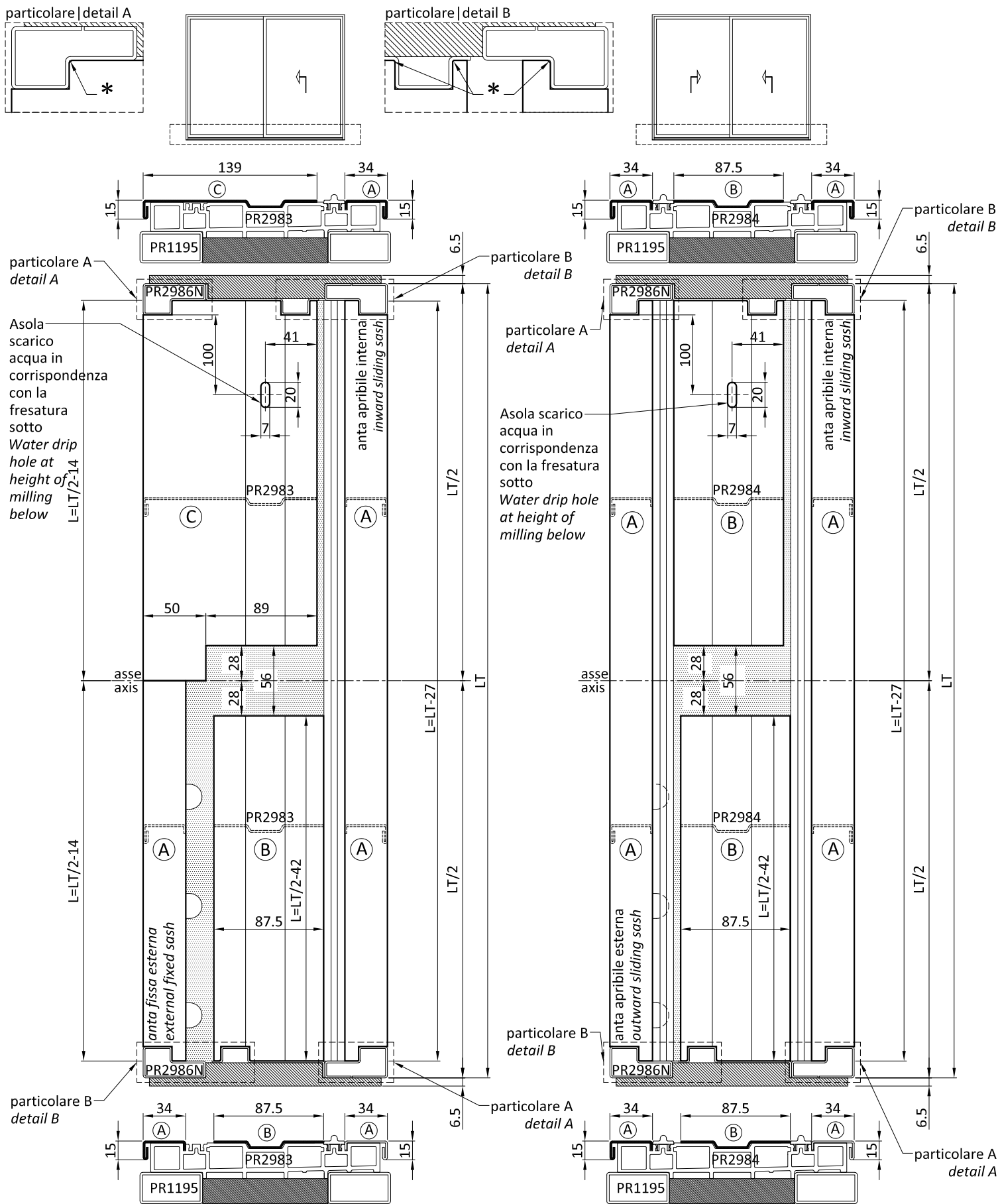

Le copertine in metallo devono essere fissate al profilo estruso PR2983-PR2984 mediante incollaggio con silicone
 The metal covers have to be attached to the extrusion profile PR2983-PR2984 with silicon
 La copertina A interna va posizionata dopo il fissaggio del serramento a terra
 Internal cover A must be put in place once the window/door has been attached on the ground

*adattare alla curva del profilo
 *adapt to the profile curve

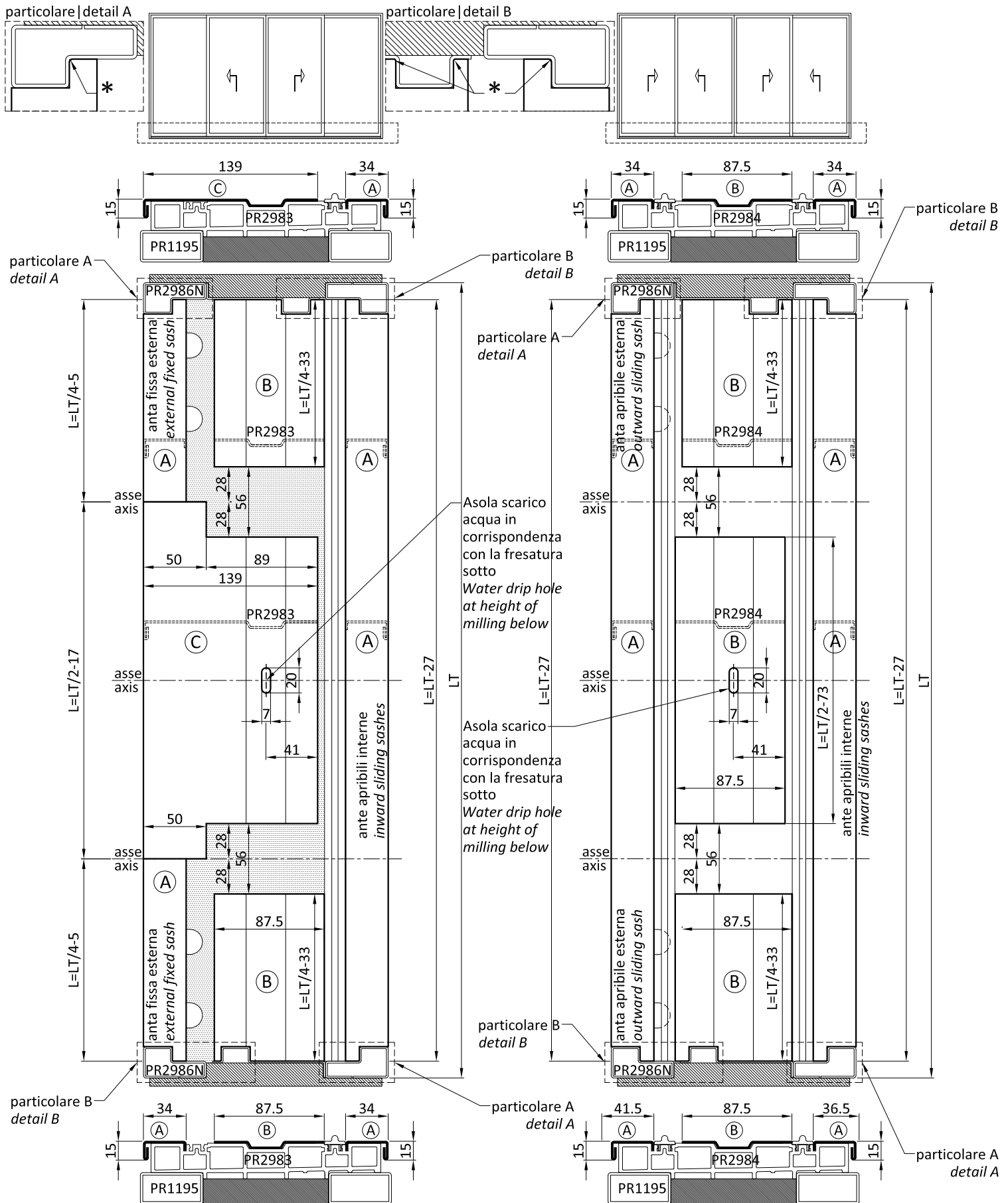

Le copertine in metallo devono essere fissate al profilo estruso PR2983-PR2984 mediante incollaggio con silicone
 The metal covers have to be attached to the extrusion profile PR2983-PR2984 with silicon
 La copertina A interna va posizionata dopo il fissaggio del serramento a terra
 Internal cover A must be put in place once the window/door has been attached on the ground

*adattare alla curva del profilo
 *adapt to the profile curve



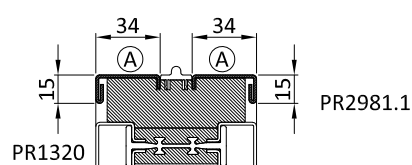
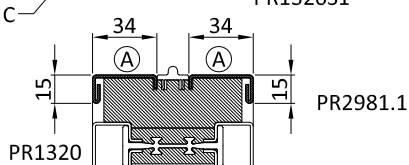
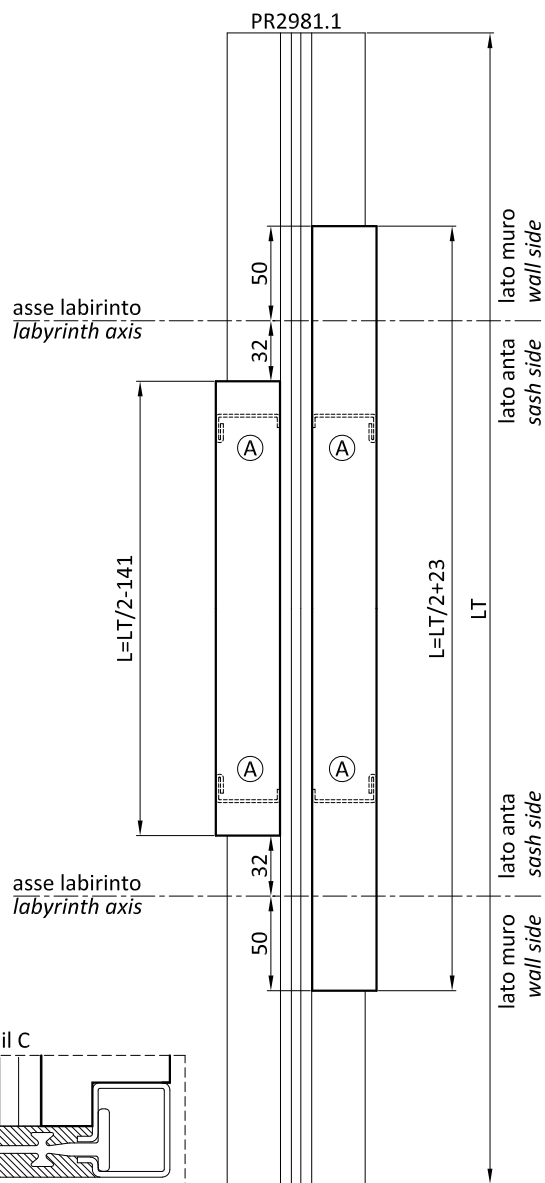
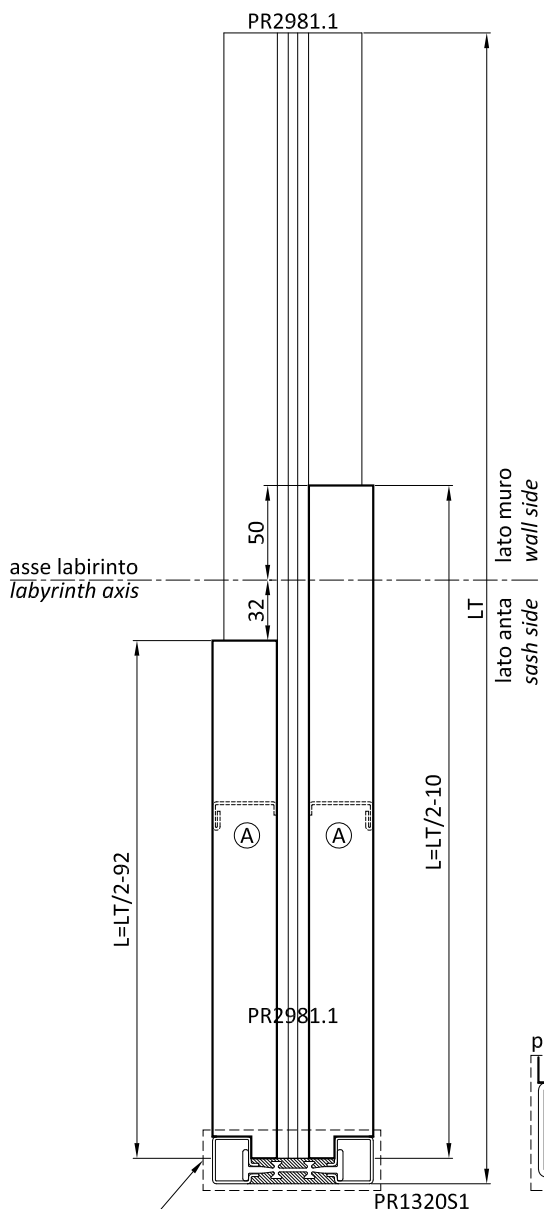
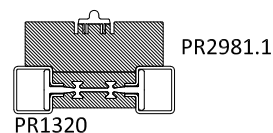
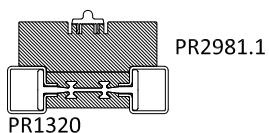
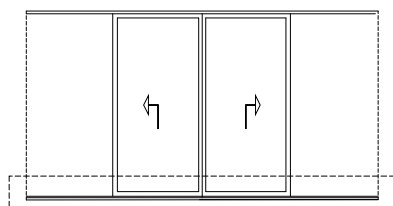
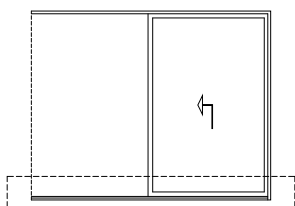

Le copertine in metallo devono essere fissate al profilo estruso del PR2981.1 mediante incollaggio con silicone
The metal covers have to be attached to the extrusion profile of PR2981.1 with silicon
La copertina A interna va posizionata dopo il fissaggio del serramento a terra
Internal cover A must be put in place once the window/door has been attached on the ground

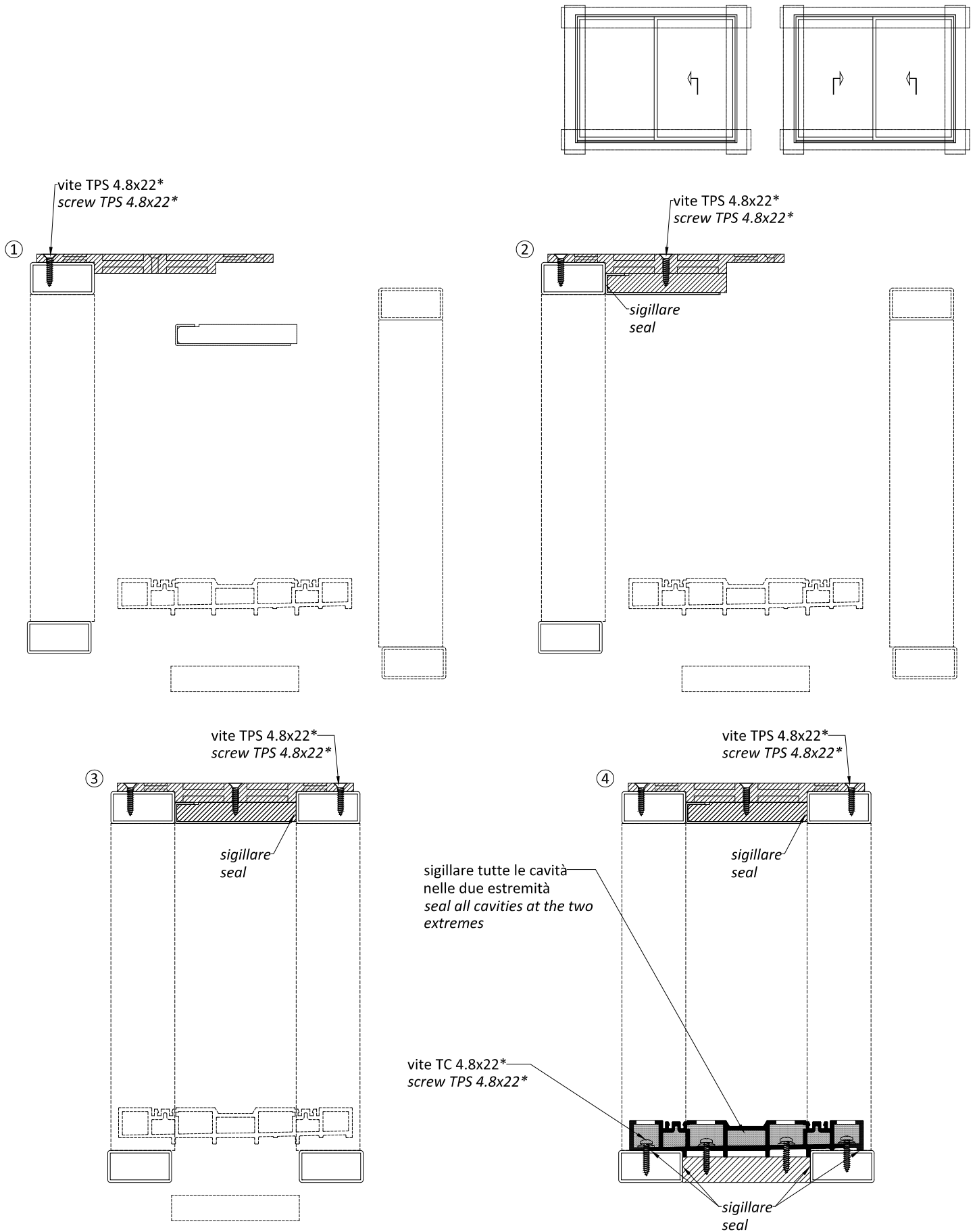

* viti TPS-TC 4.8x22 non comprese
* screws TPS-TC 4.8x22 not supplied

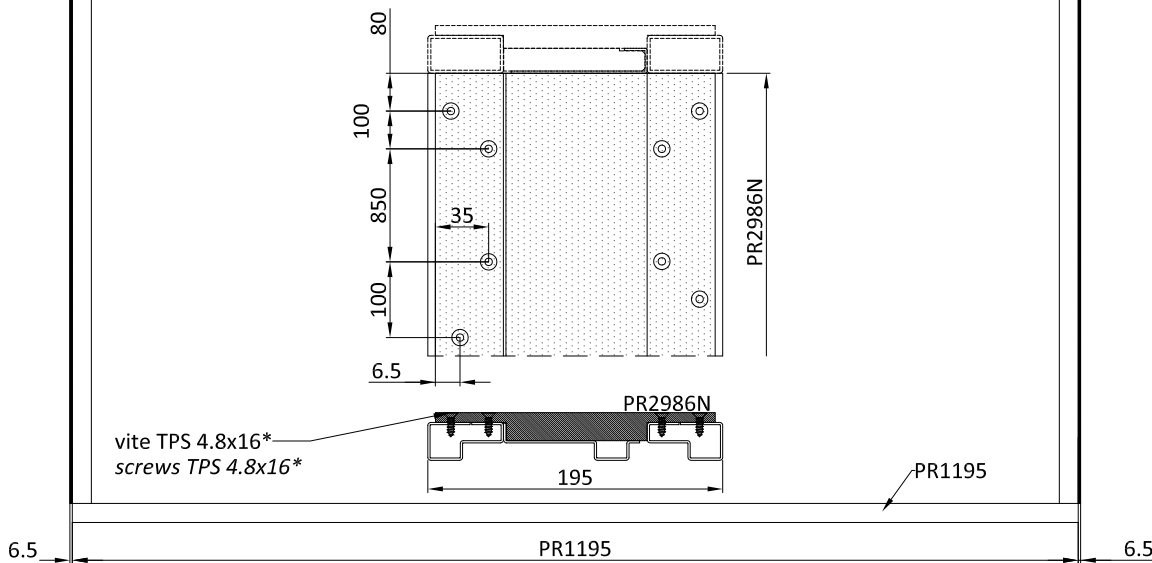
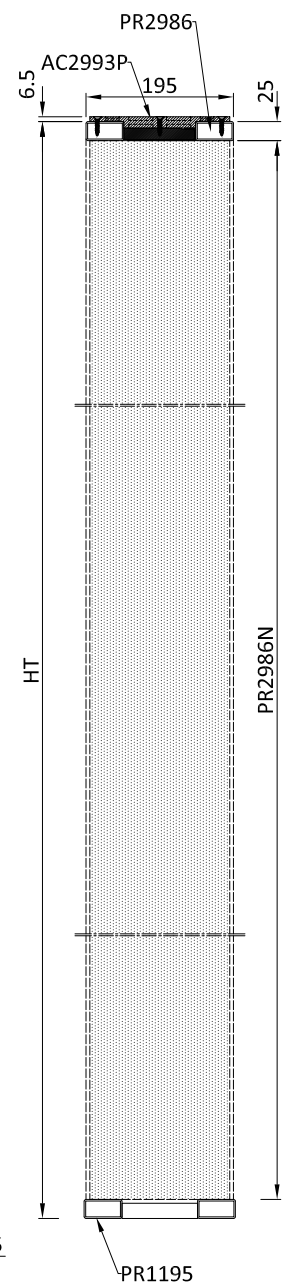
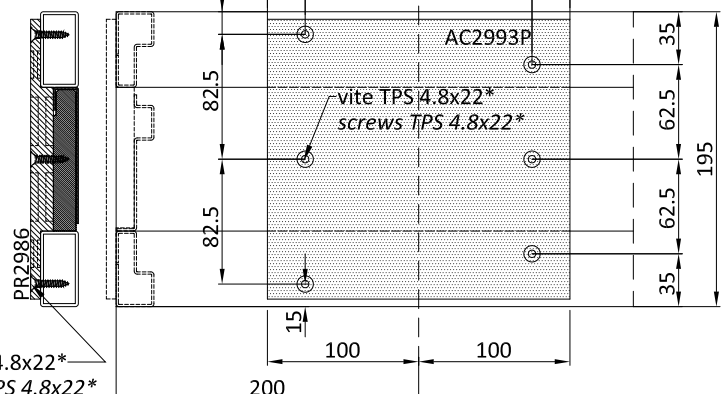
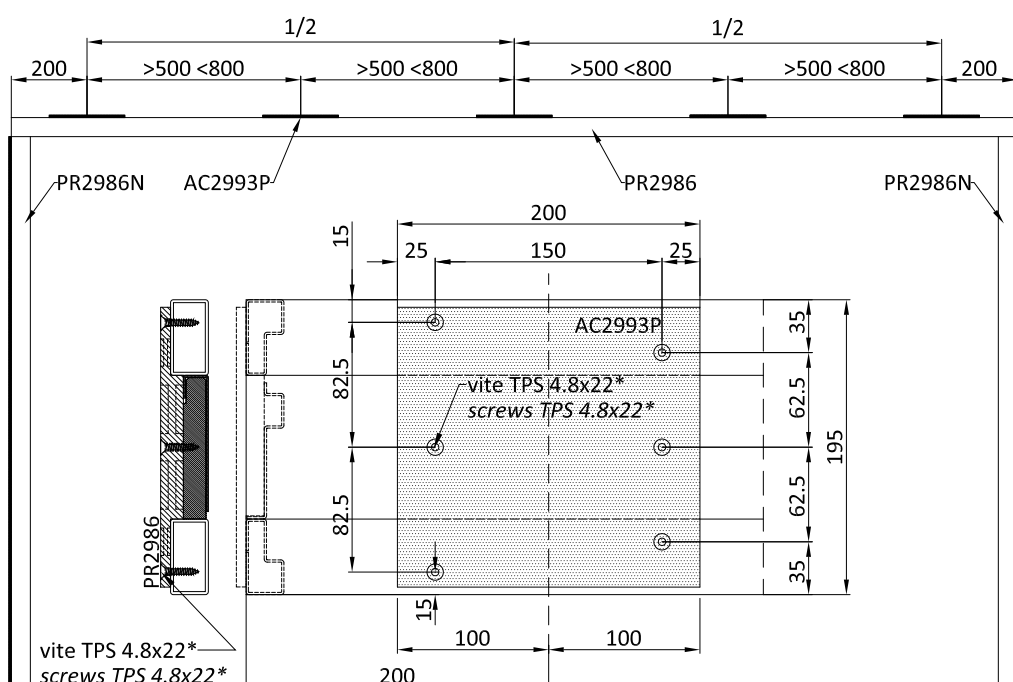
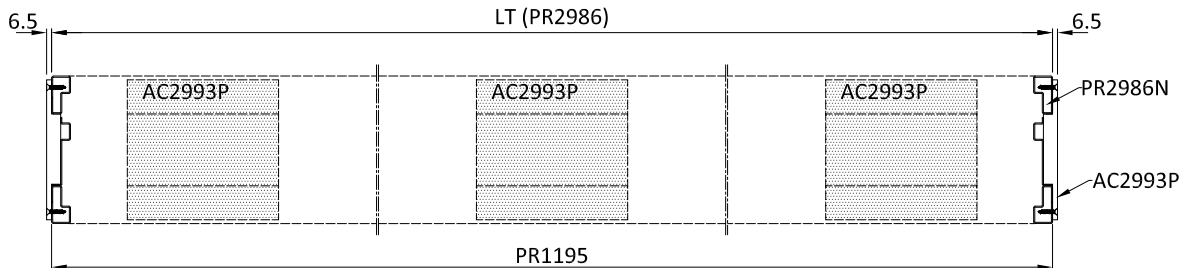
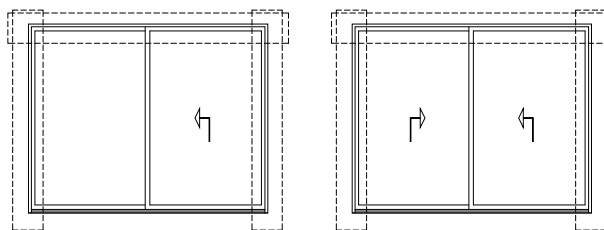

* viti TPS-TC 4.8x16/22 non comprese | screws TPS-TC 4.8x16/22 not supplied

lavorazione valida anche per guida singola
 processing also valid for individual rail

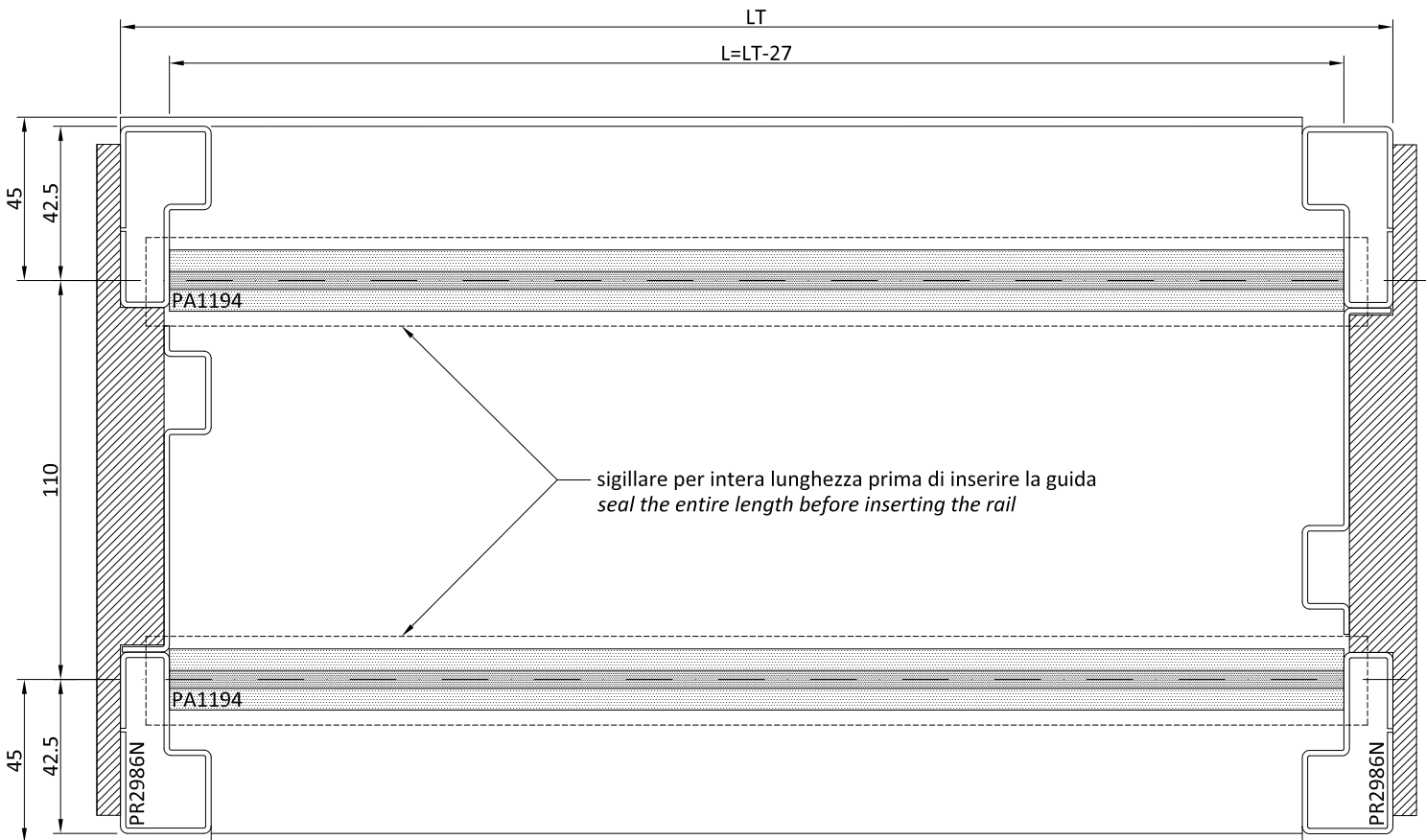
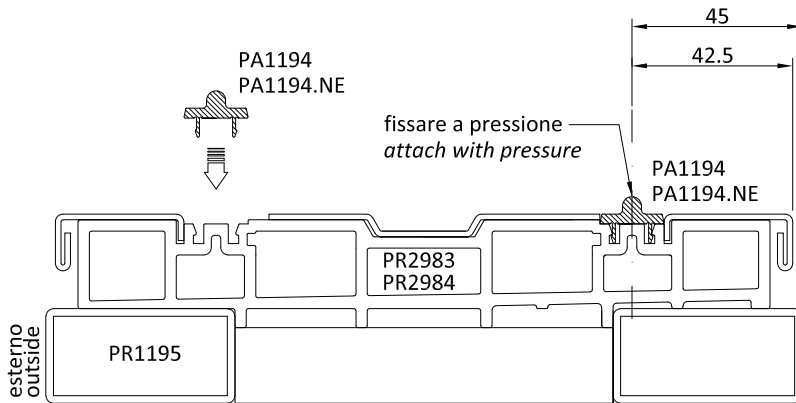
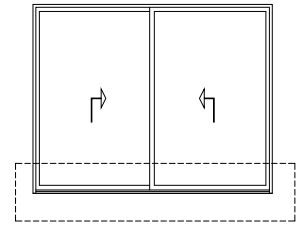

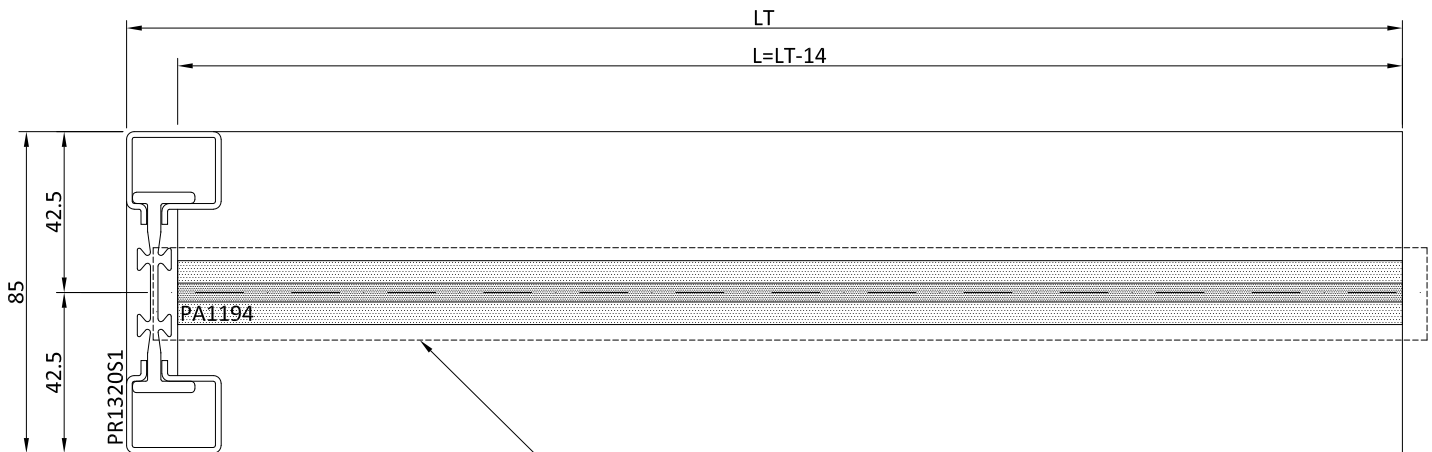
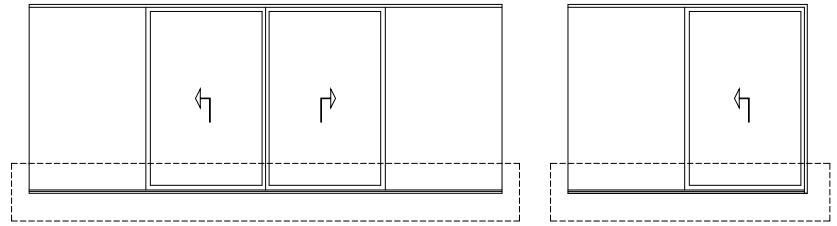
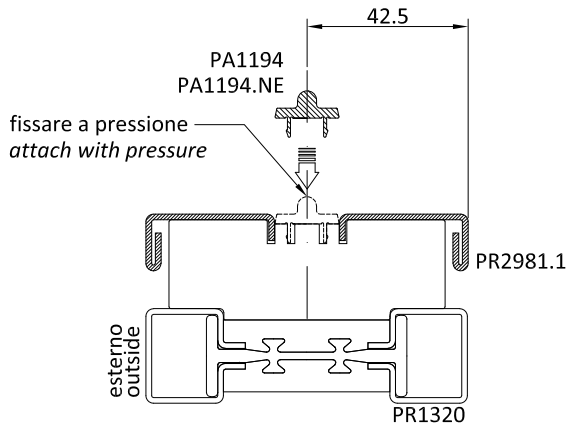

sigillare per intera lunghezza prima di inserire la guida
 seal the entire length before inserting the rail

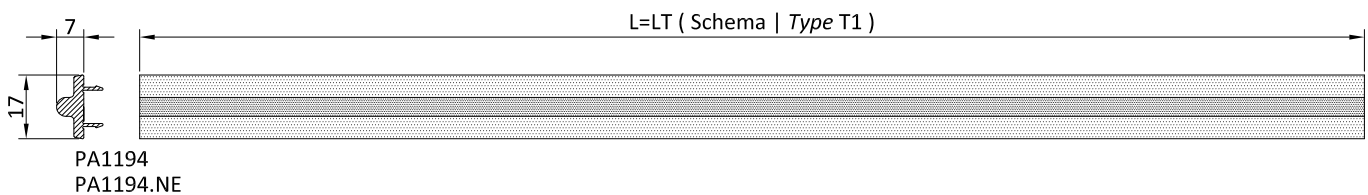
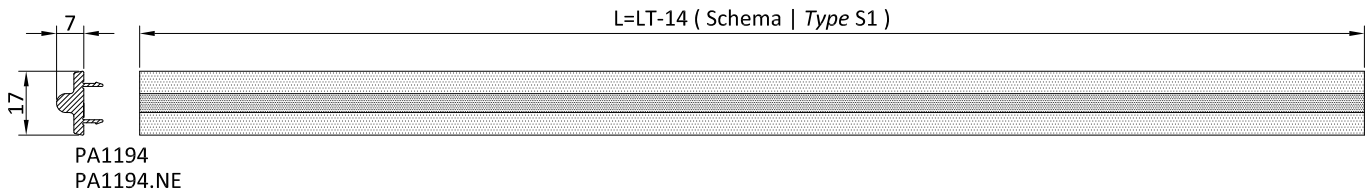

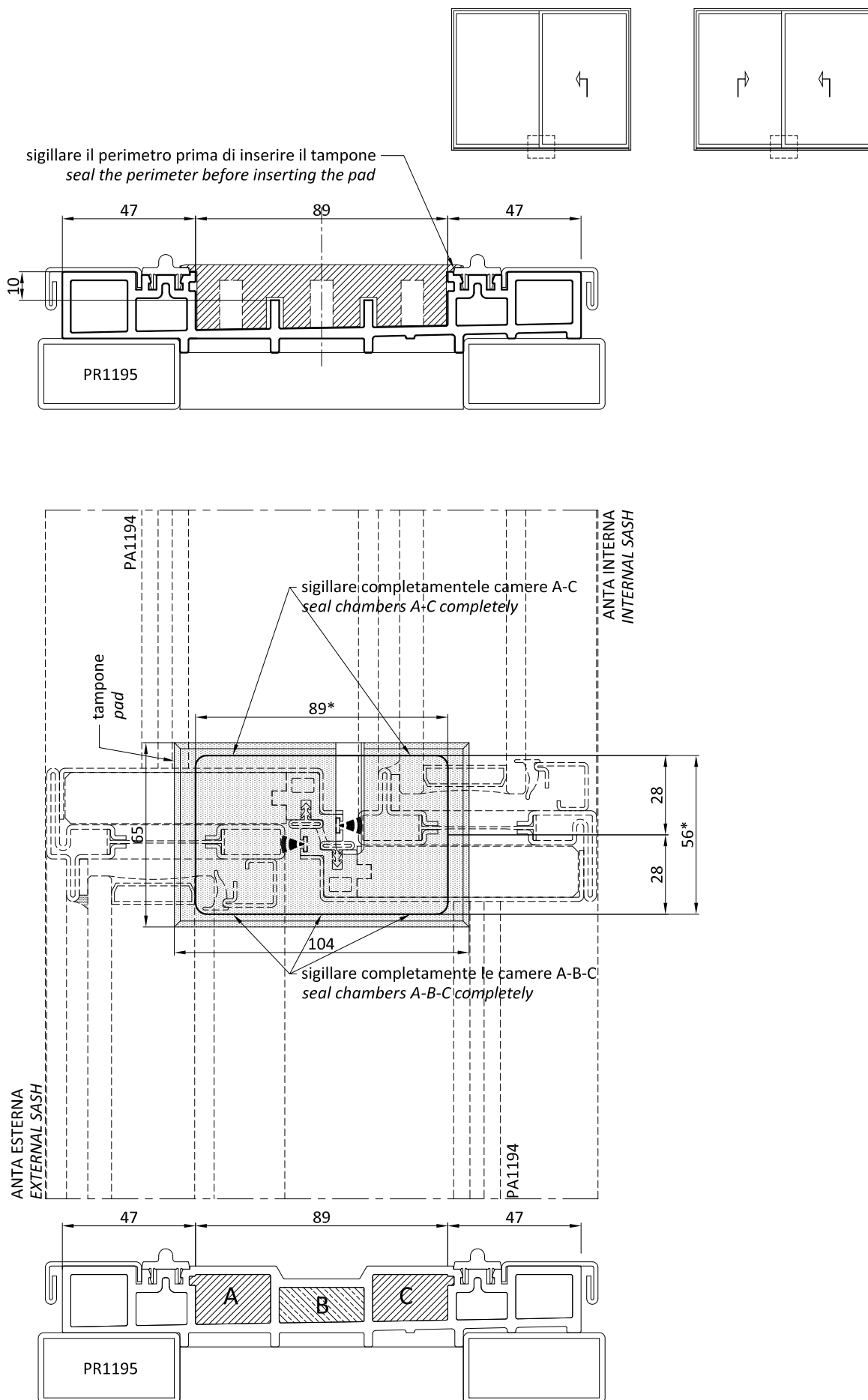

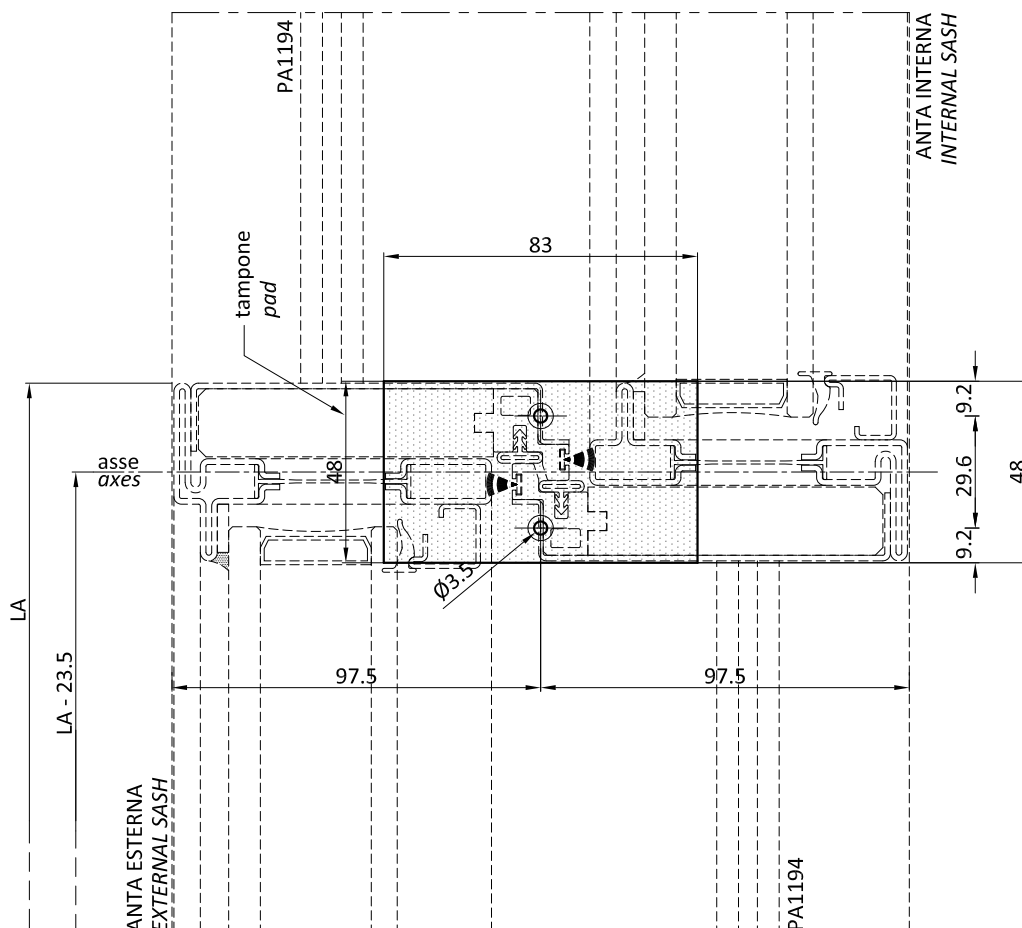
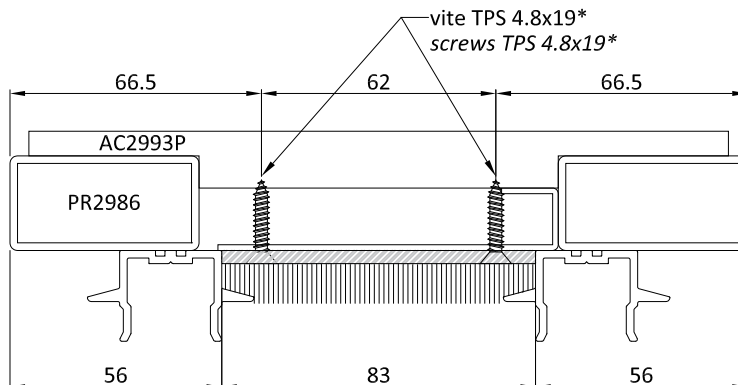
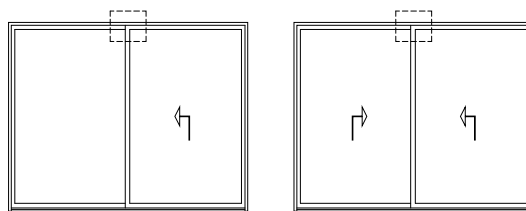

NOTE:

- Inserire e fissare la prima guida con la rispettiva anta
- Inserire e fissare il tampone
- Inserire e fissare la seconda guida con la rispettiva anta

NOTE:

- Insert and attach the first rail with respective sash*
- Insert and attach the pad*
- Insert and attach the second rail with respective sash*

* viti TPS 4.2 x 19 non comprese
* screws TPS 4.2 x 19 not supplied



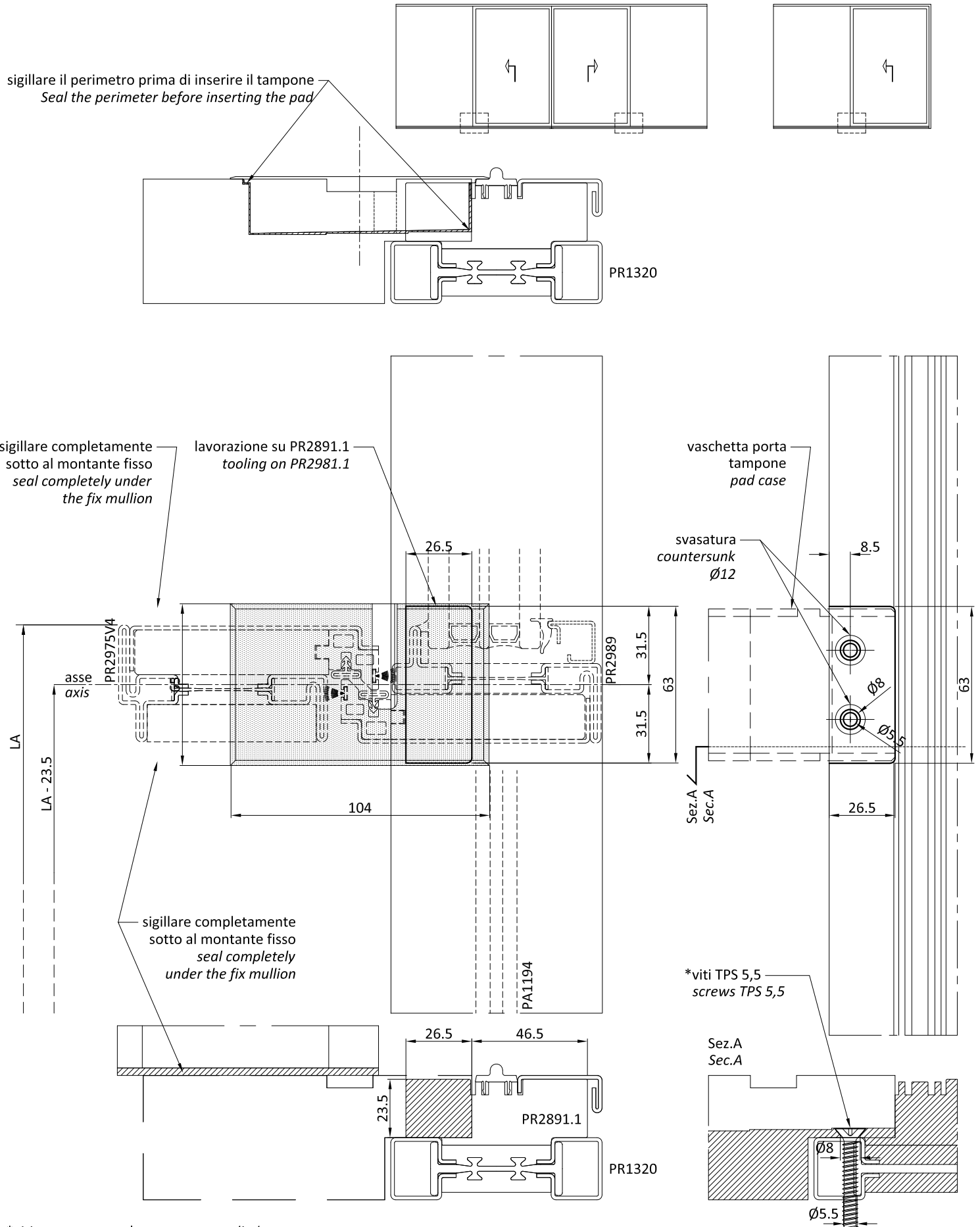

*viti non comprese | screws not supplied



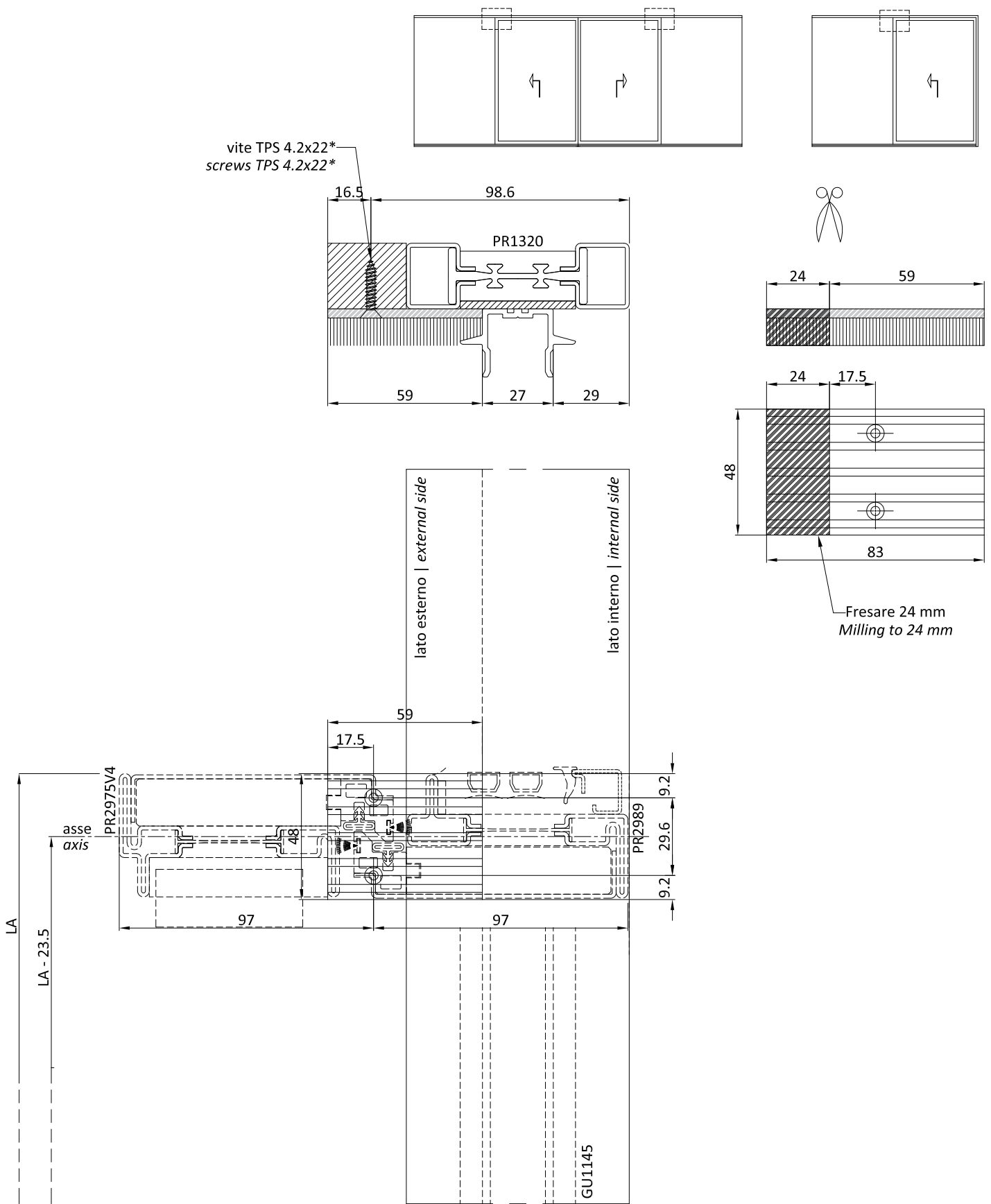

NOTE:

- Inserire e fissare la prima guida con la rispettiva anta
- Inserire e fissare il tampone
- Inserire e fissare la seconda guida con la rispettiva anta

NOTE:

- Insert and attach the first rail with respective sash
- Insert and attach the pad
- Insert and attach the second rail with respective sash

* viti TPS 4.2x22 non comprese
* screws TPS 4.2x22 not supplied



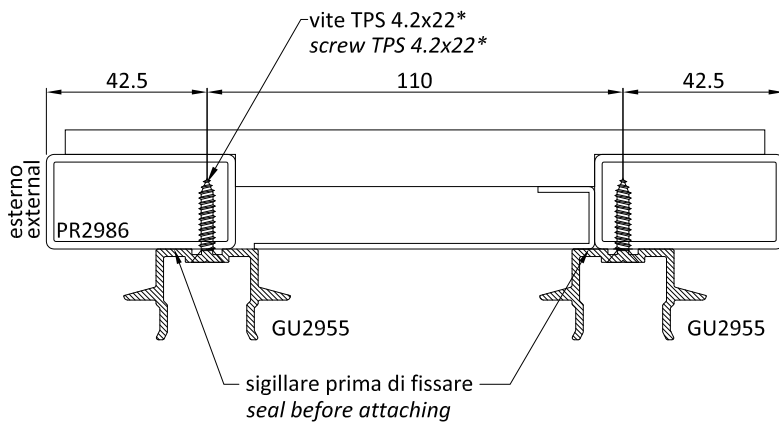

Schema | Type A

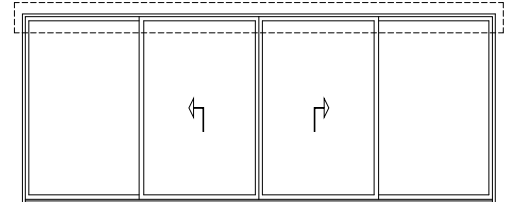

Schema | Type E

NOTE :

- Preforare il telaio PR2986 prima dell'assemblaggio
- Montare la guida assieme alla posa dell'anta

NOTE:

- Perforate frame PR2986 before assemblage
- Mount the rail when attaching the sash

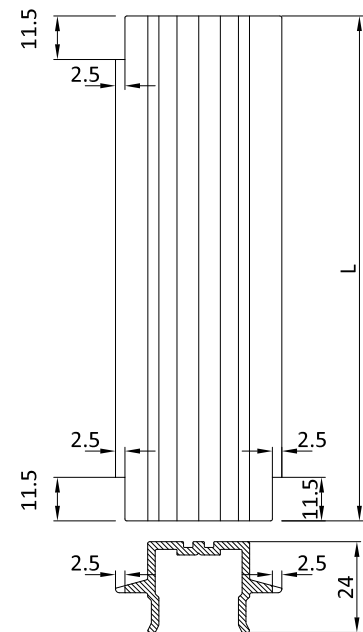
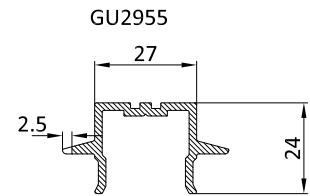
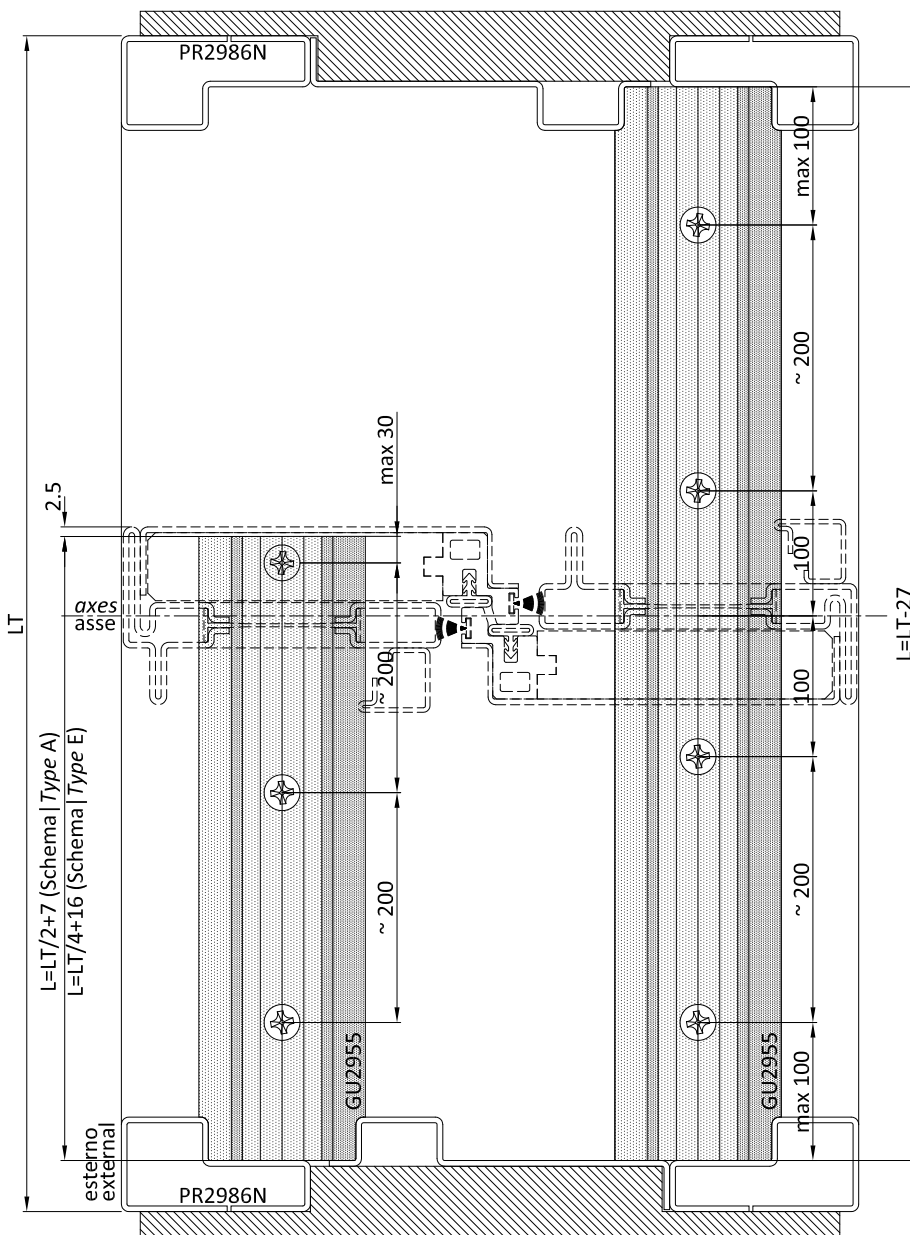

GU2955:

Schema | Type A-E

lunghezza guida interna | lenght internal rail
L=LT-27

Schema A | Type A

lunghezza guida esterna | lenght external rail
L=LT/2+9 (2 pz | pc)

Schema E | Type E

lunghezza guida esterna | lenght external rail
L=LT/4+15 (2 pz | pc)

* viti TPS 4.2x22 non comprese
* screws TPS 4.2x22 not supplied

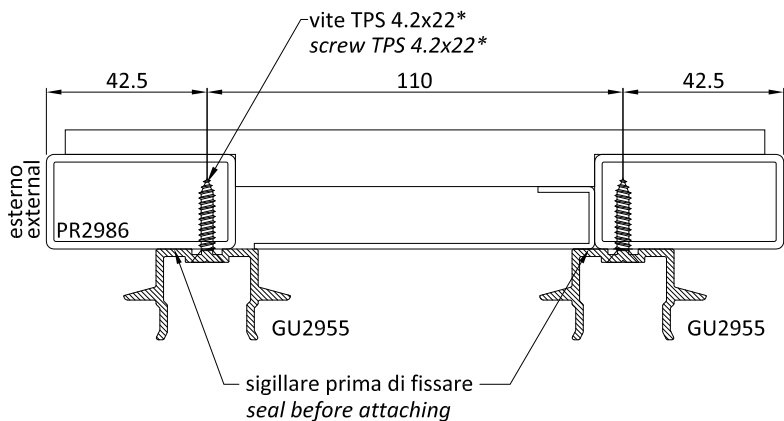

Schema | Type B

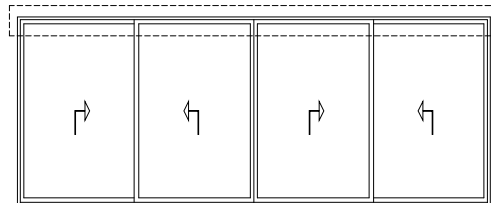

Schema | Type F

NOTE :

- Preforare il telaio PR2986 prima dell'assemblaggio
- Montare la guida assieme alla posa dell'anta

NOTE:

- Perforate frame PR2986 before assemblage
- Mount the rail when attaching the sash

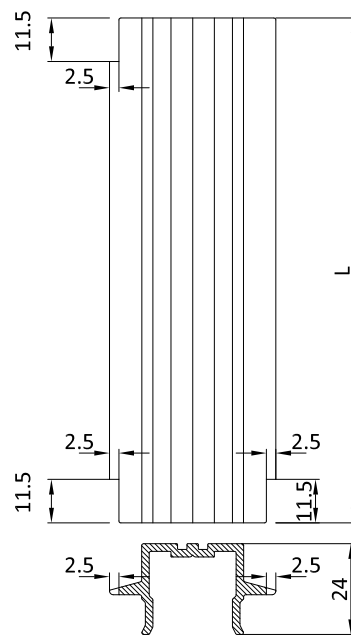
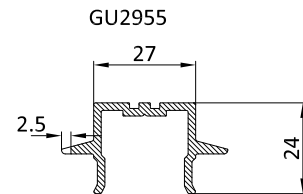
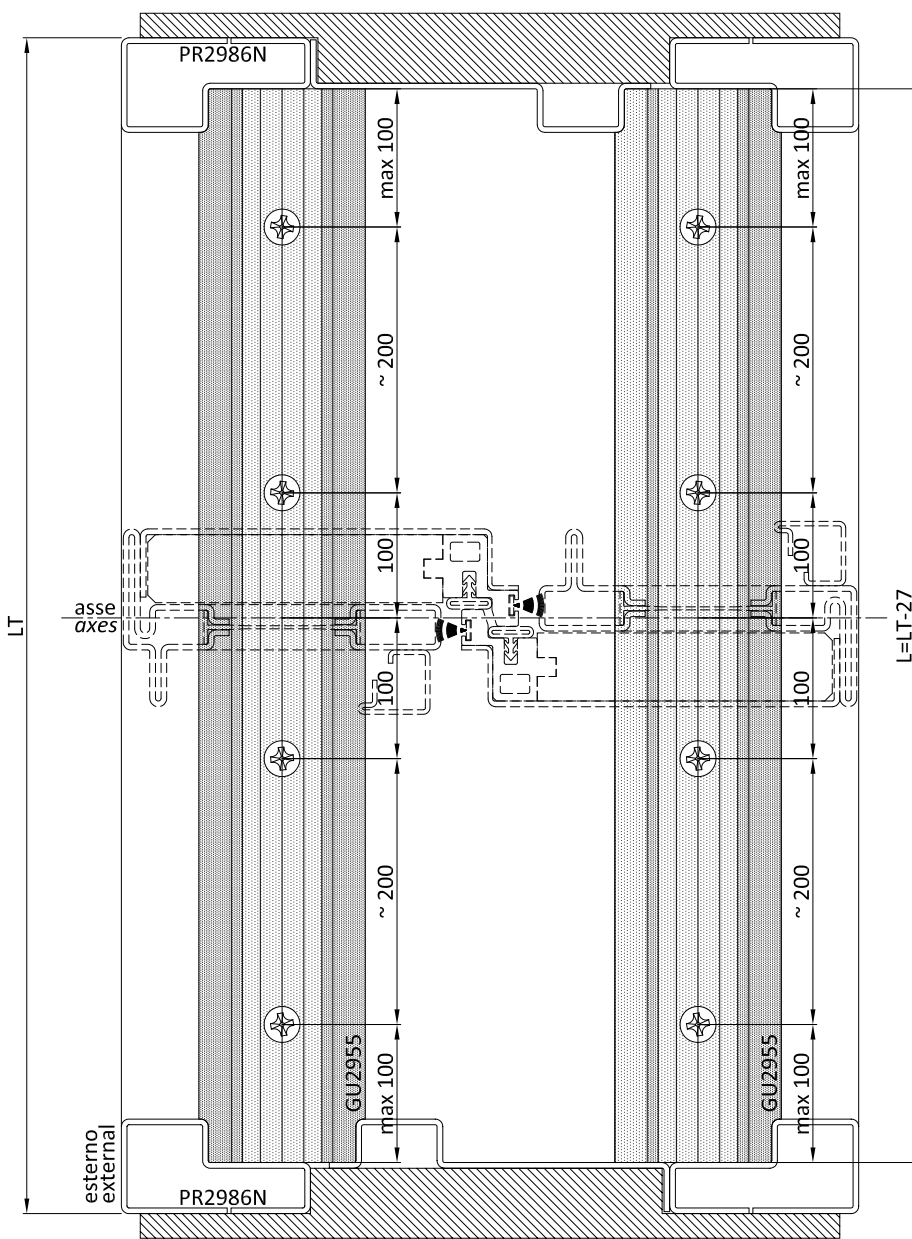

GU2955:

Schema | Type B-F
lunghezza guida interna ed esterna
length internal and external rail
 $L=LT-27$ (2 pz|pc)

* viti TPS 4.2x22 non comprese
* screws TPS 4.2x22 not supplied

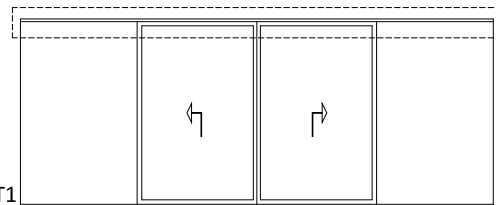
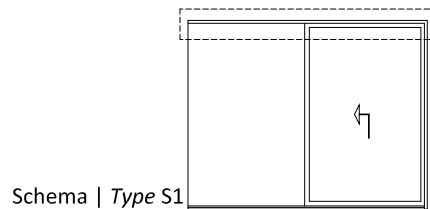
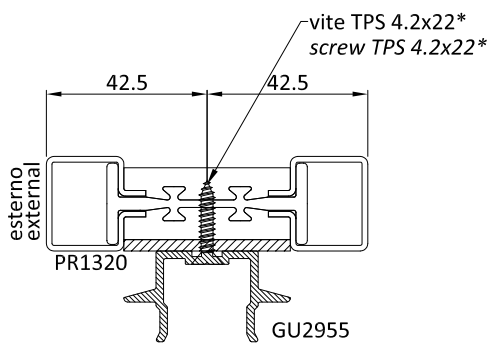

Schema | Type T1

NOTE :

- Preforare il telaio PR1320 prima dell'assemblaggio
- Montare la guida assieme alla posa dell'anta

NOTE:

- Perforate frame PR1320 before assemblage
- Mount the rail when attaching the sash

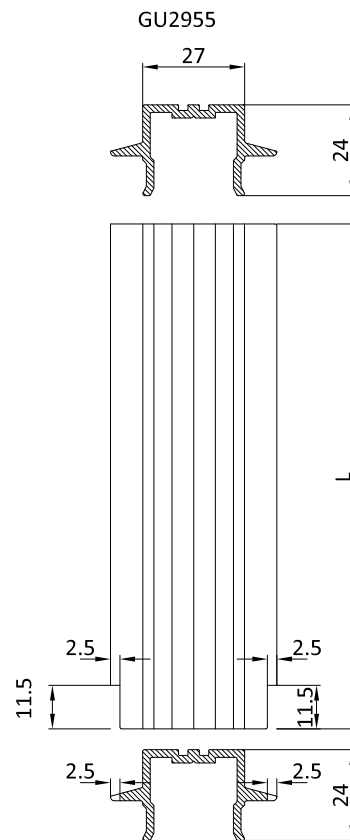
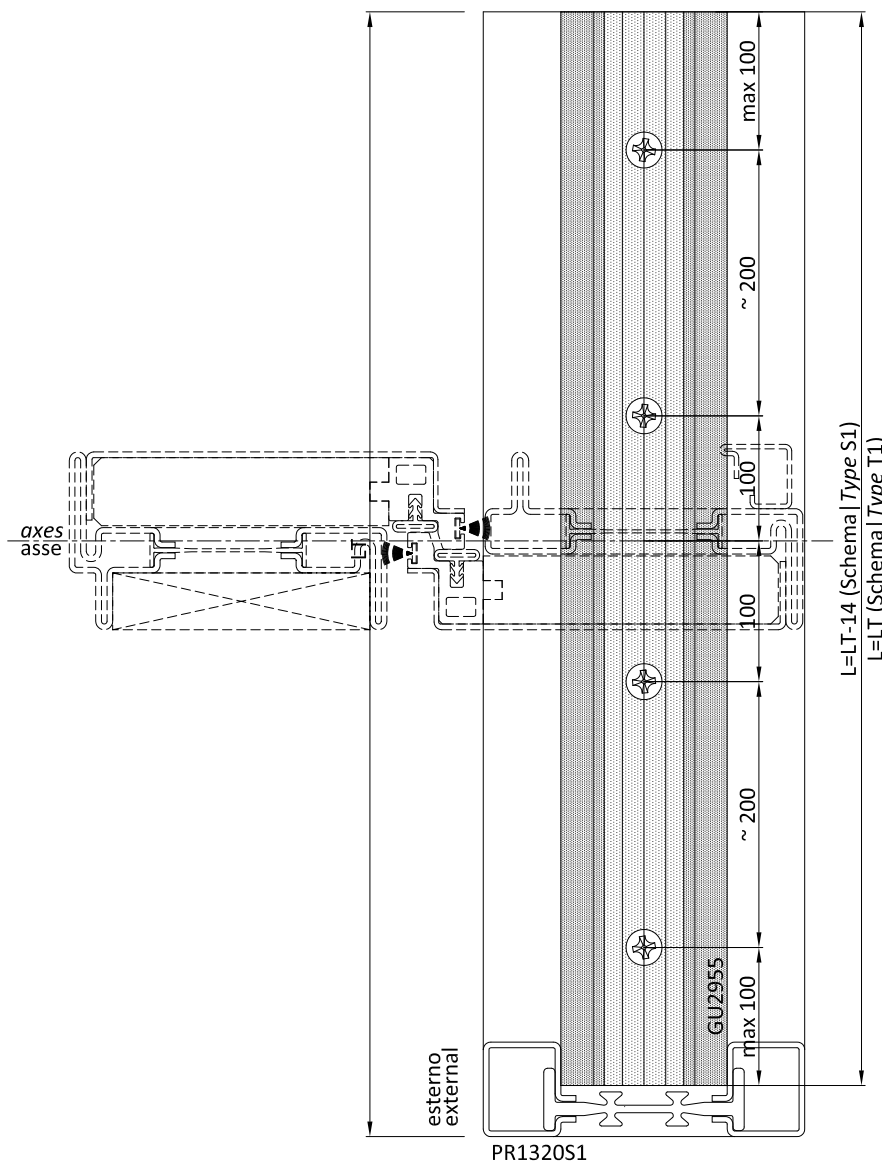

GU2955:
 Schema | Type S1
 lunghezza guida | length rail
 L=LT-14

Schema | Type T1
 lunghezza guida | length rail
 L=LT

* viti TPS 4.2x22 non comprese
 * screws TPS 4.2x22 not supplied

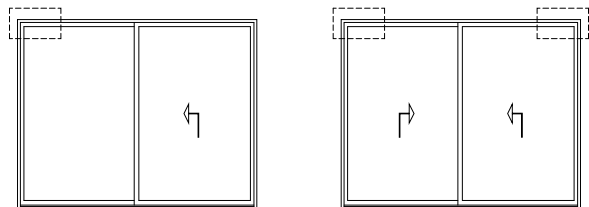
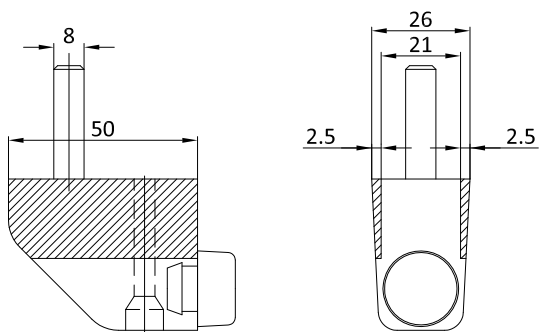

lavorazione valida anche per guida singola
 processing also valid for individual rail

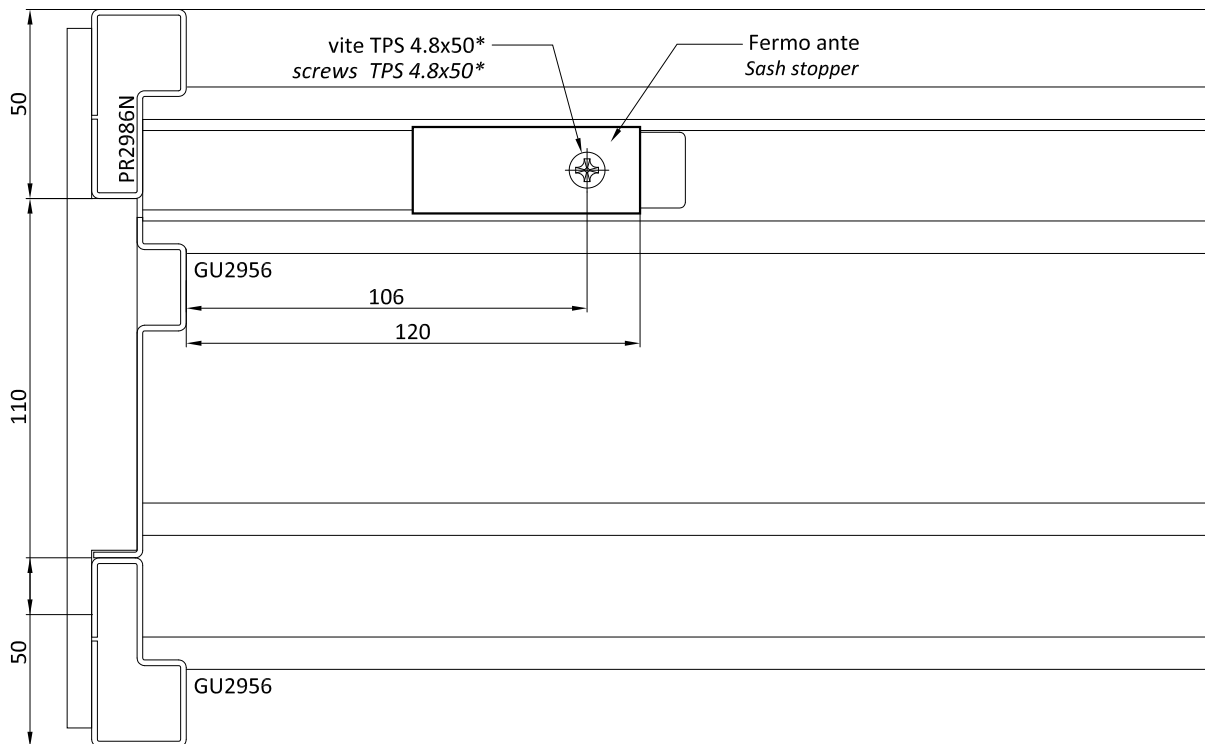
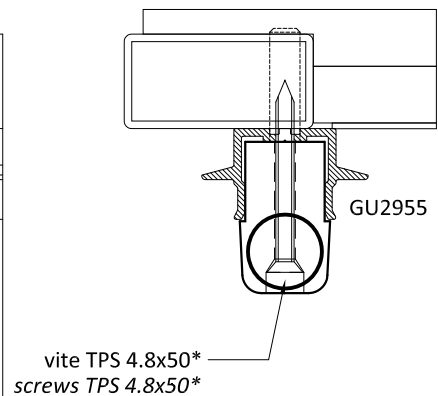
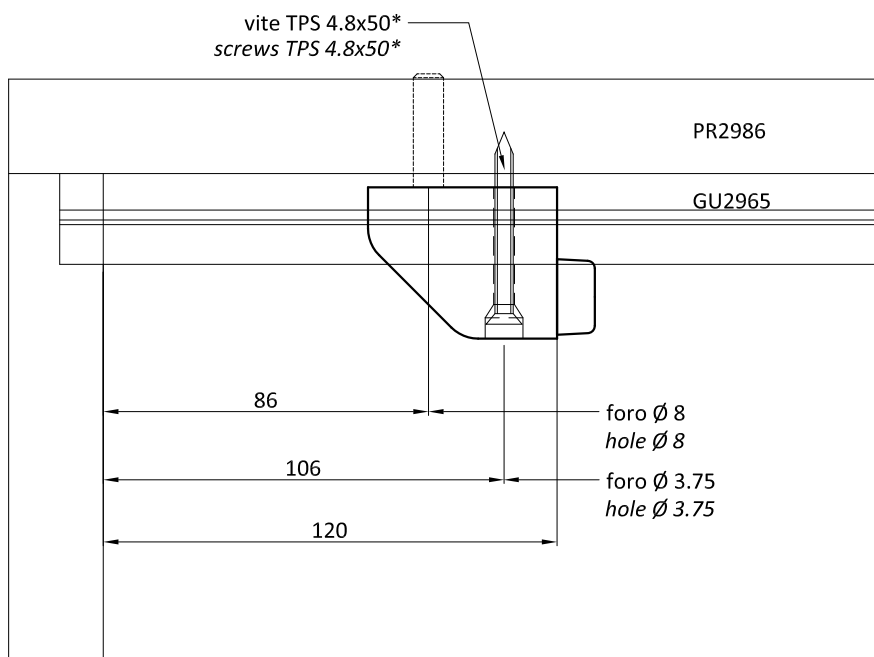

* vite TPS 4.8x50 non comprese
 * screws TPS 4.8x50 not supplied

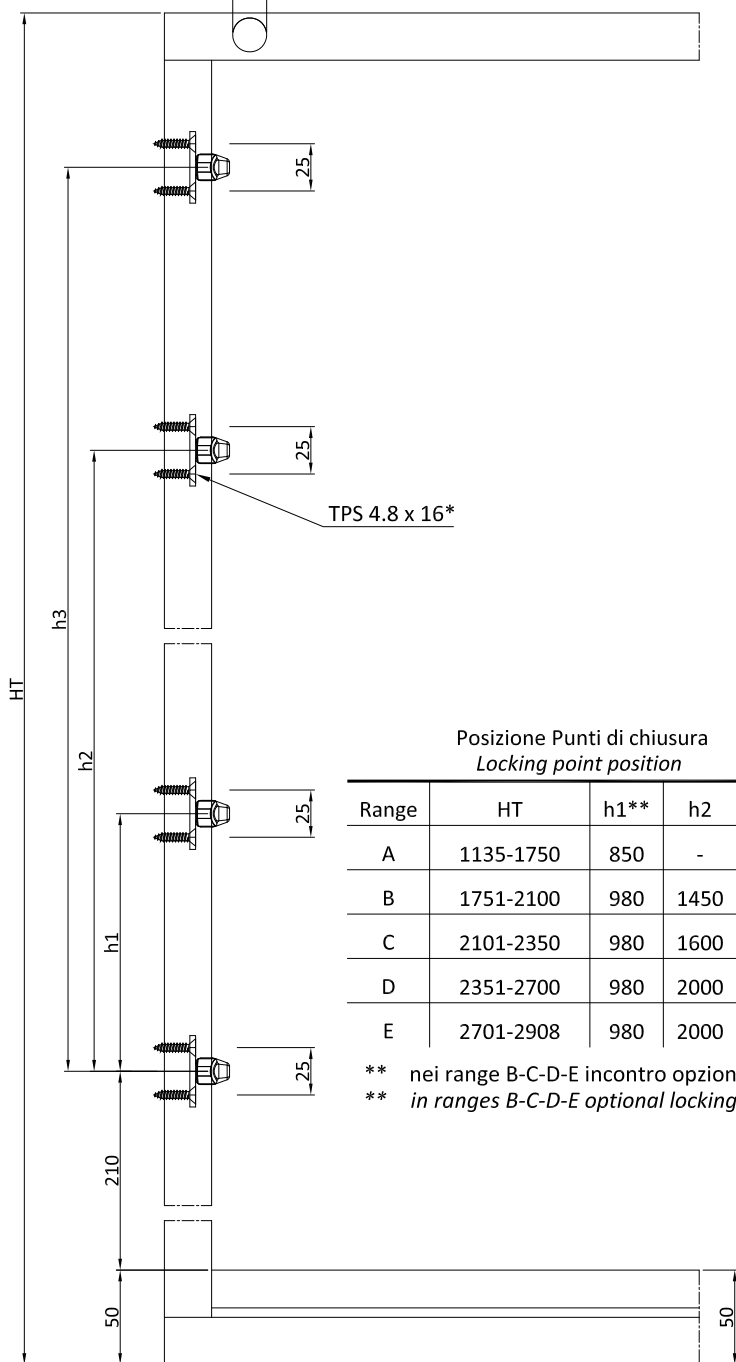
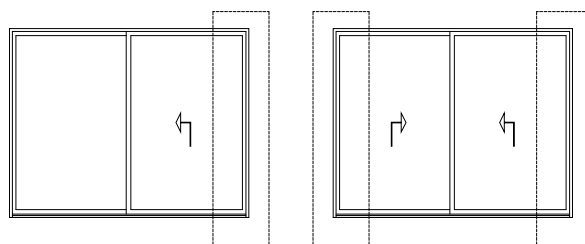
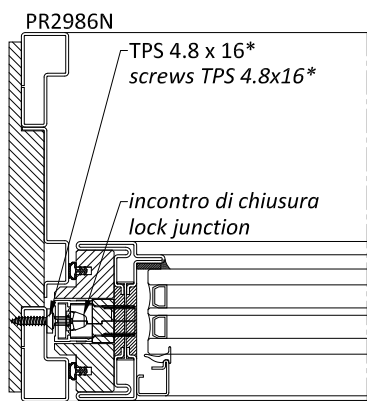

Posizione Punti di chiusura
Locking point position

Range	HT	h1**	h2	h3
A	1135-1750	850	-	-
B	1751-2100	980	1450	-
C	2101-2350	980	1600	-
D	2351-2700	980	2000	-
E	2701-2908	980	2000	VAR.

** nei range B-C-D-E incontro opzionale
** in ranges B-C-D-E optional locking

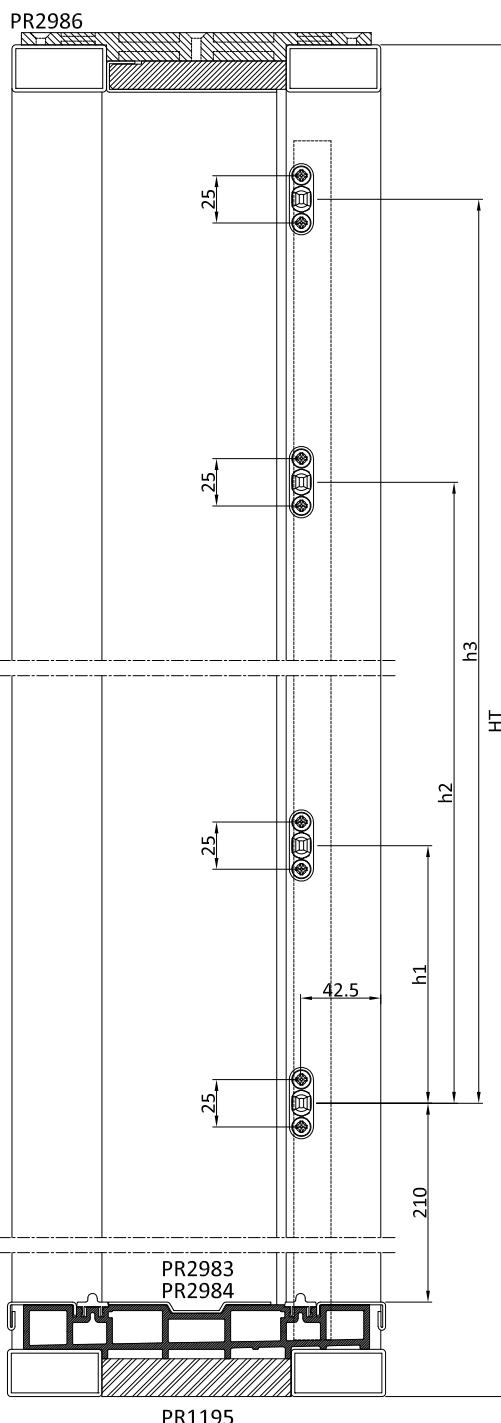

* viti TPS 4.8x16 non comprese
* screws TPS 4.8x16 not supplied

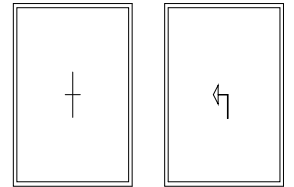

saldare le parti a contatto
seam-weld all contact surfaces

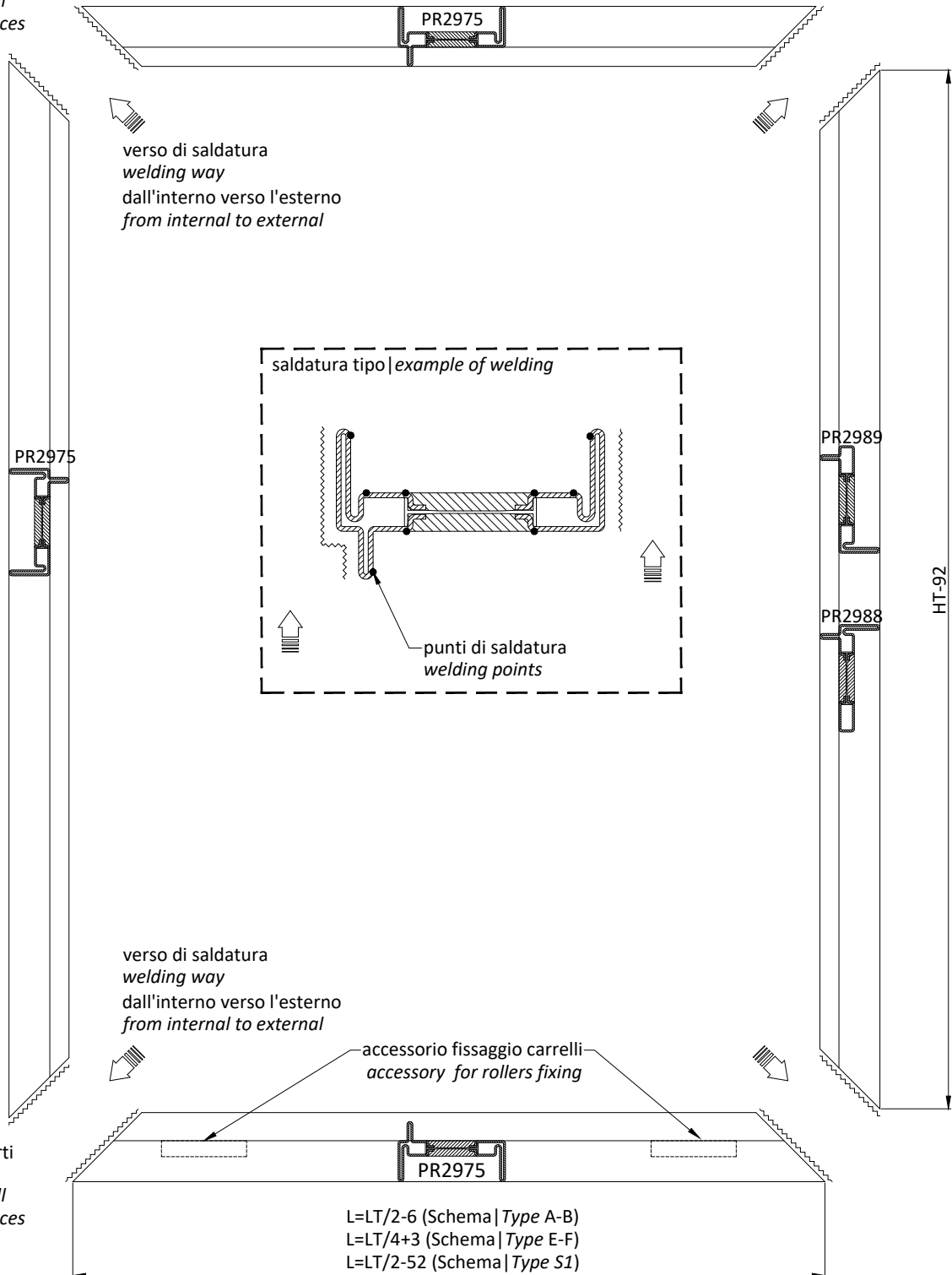

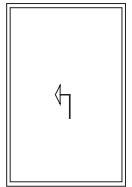

saldare le parti
a contatto
seam-weld all
contact surfaces

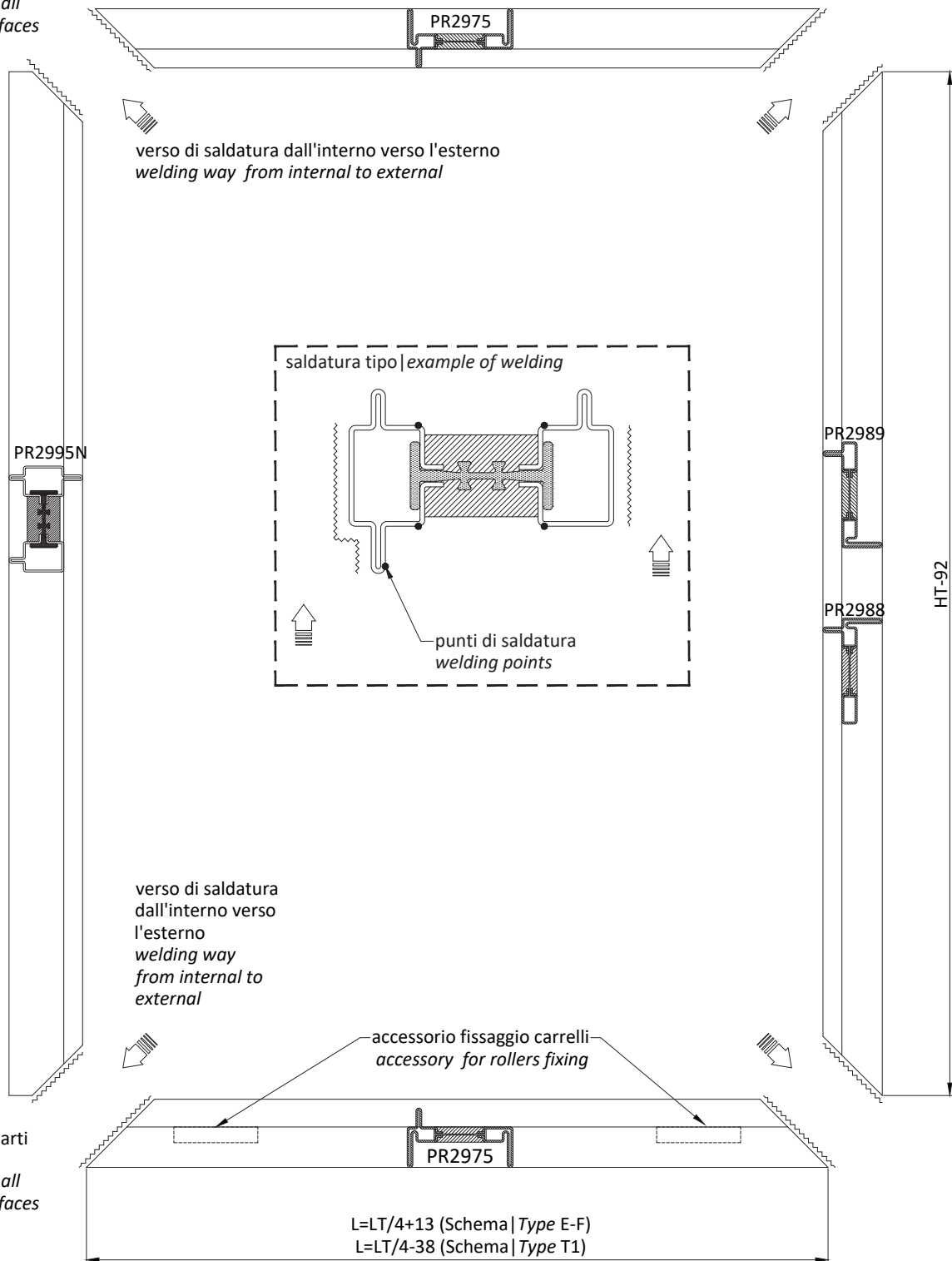

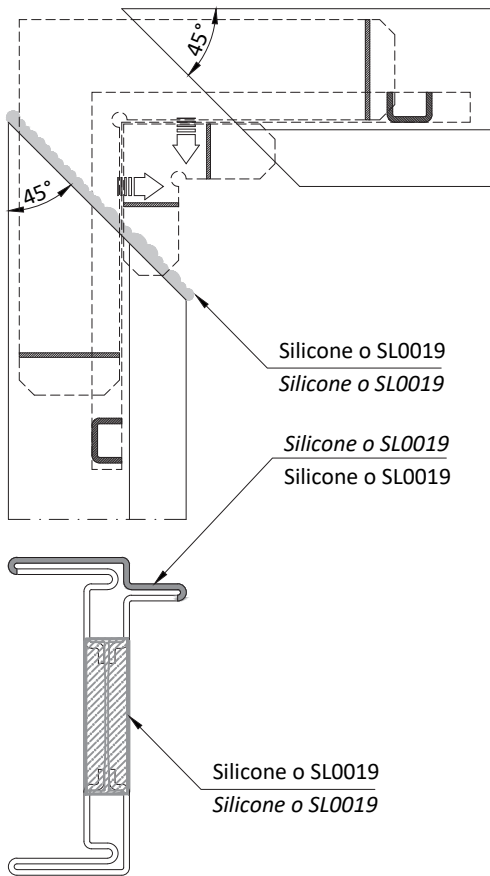

- 1) inserire la squadretta
- 2) siliconare nelle zone indicate
- 3) accostare i profili
- 4) procedere con la saldatura (vedasi pagine successive)

- 1) insert the bracket
- 2) seal in the specified areas
- 3) align the profiles
- 4) weld (see following pages)

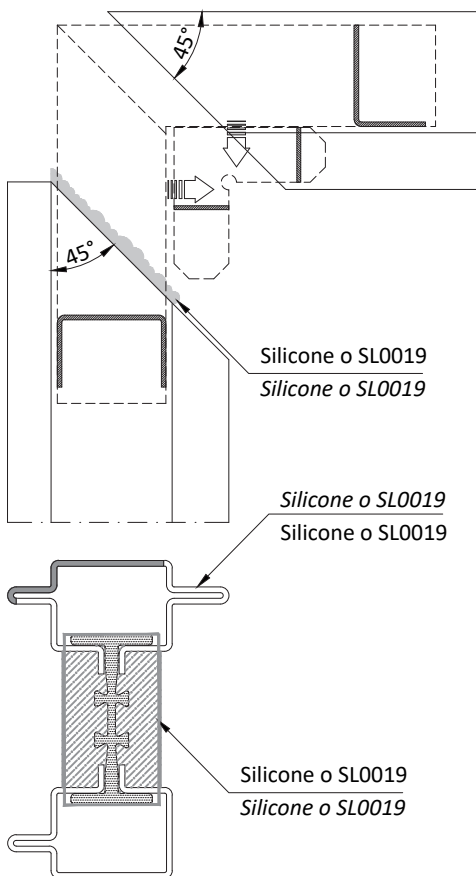
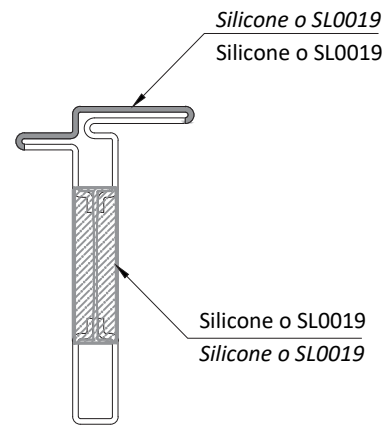
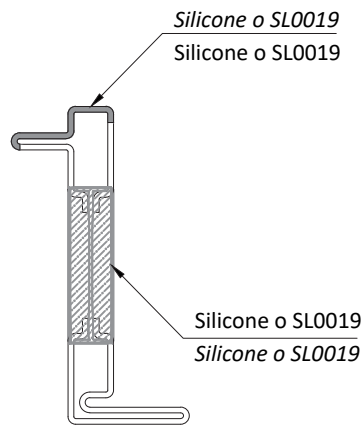
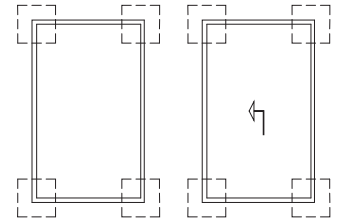

- 1) inserire la squadretta
- 2) siliconare nelle zone indicate
- 3) accostare i profili
- 4) procedere con la saldatura (vedasi pagine successive)

- 1) insert the bracket
- 2) seal in the specified areas
- 3) align the profiles
- 4) weld (see following pages)

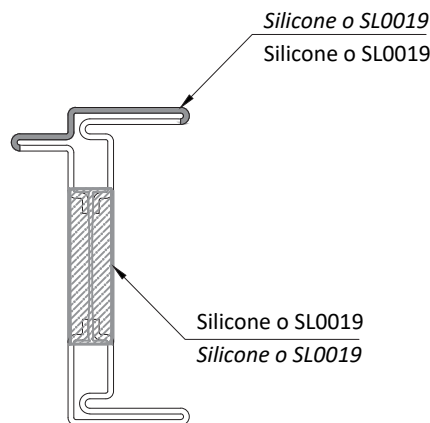

■ Sigillare con silicone o sigillante a freddo SL0019 nelle zone evidenziate (sempre lato esterno profilo)
■ Seal with silicone or cold-working sealant SL0019 in the areas marked (always on the outer side of the profile)

Profili | Profiles

Prospetto | View
Vista interna | Internal view

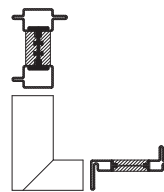
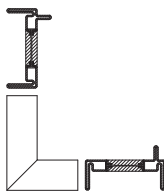

Schema | Type A

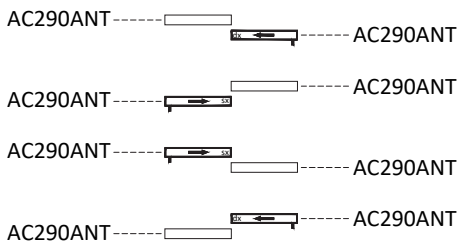
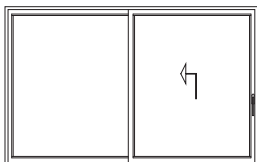

Schema | Type B

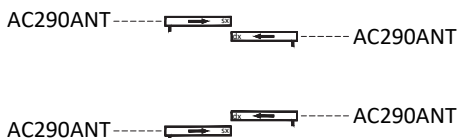
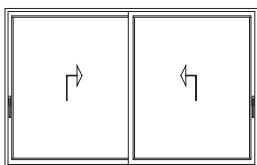

Schema | Type E

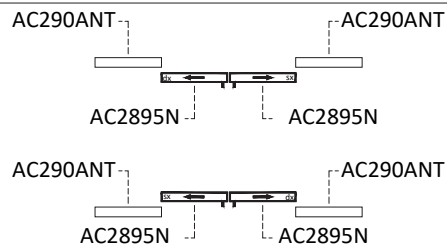
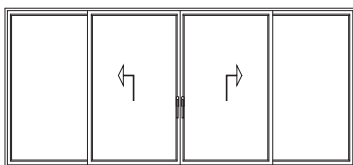

Schema | Type F

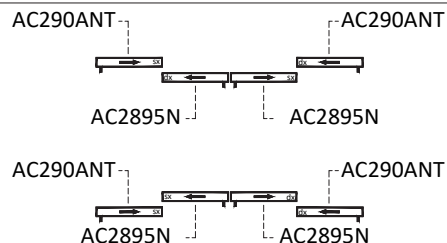
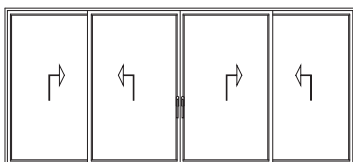

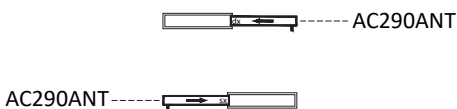
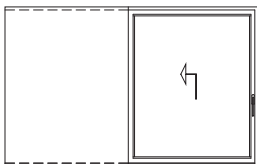

Schema | Type S1



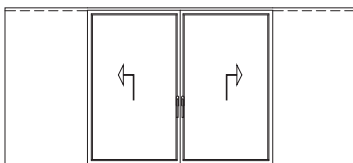

Schema | Type T1

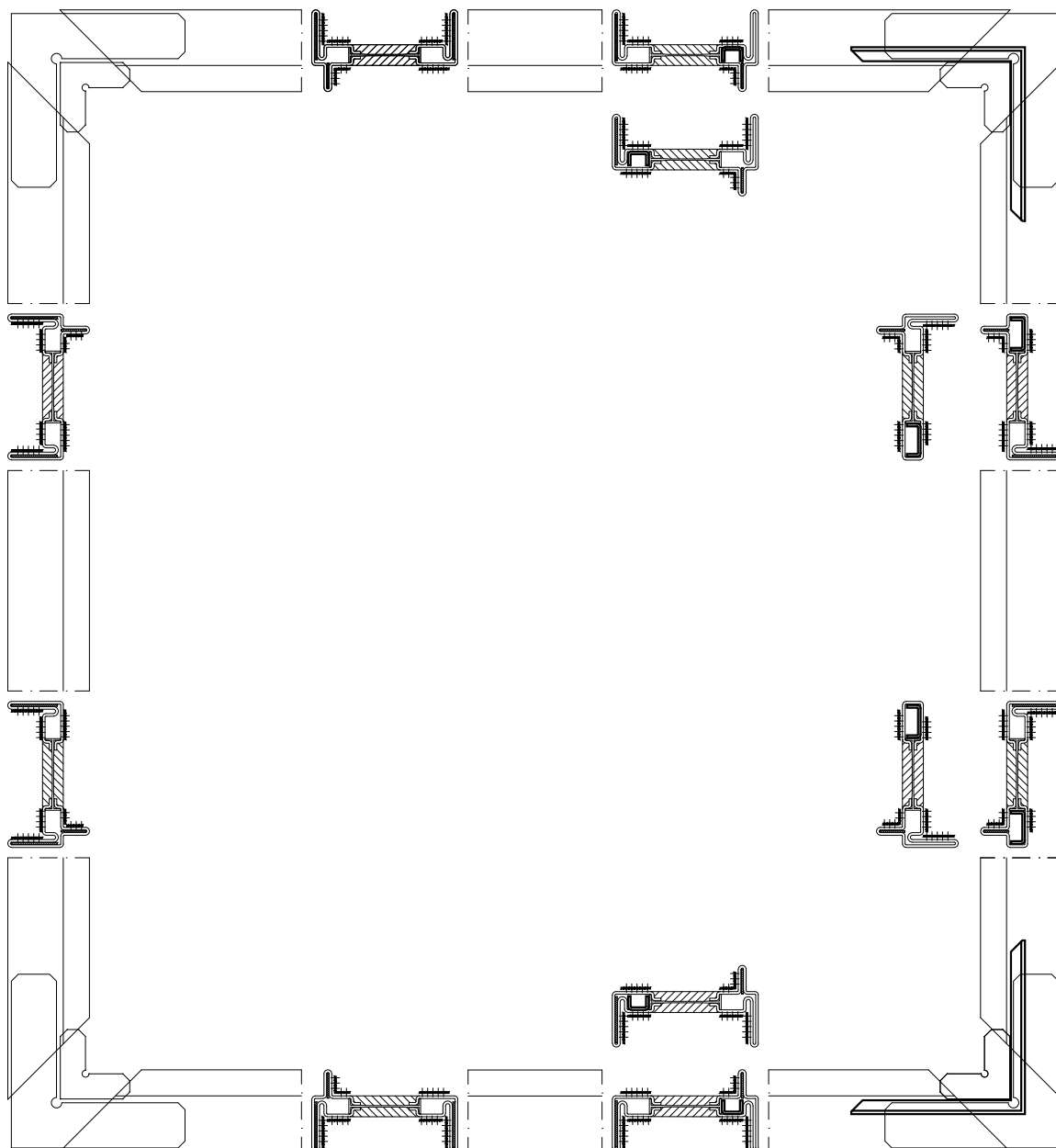
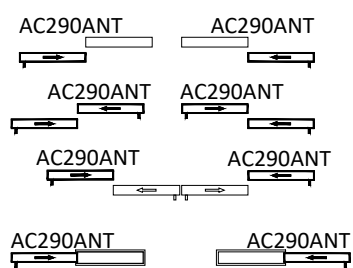

Saldare a TIG con materiale di riporto nelle zone indicate con 
TIG welding with filler material in the areas indicated with 

Sigillare tutte le superfici di contatto esterne con silicone o SL0019
Seal all the external contact surfaces with silicone or SL0019



Saldare a TIG con materiale di riporto nelle zone indicate con 
TIG welding with filler material in the areas indicated with 

Sigillare tutte le superfici di contatto esterne con silicone o SL0019
Seal all the external contact surfaces with silicone or SL0019

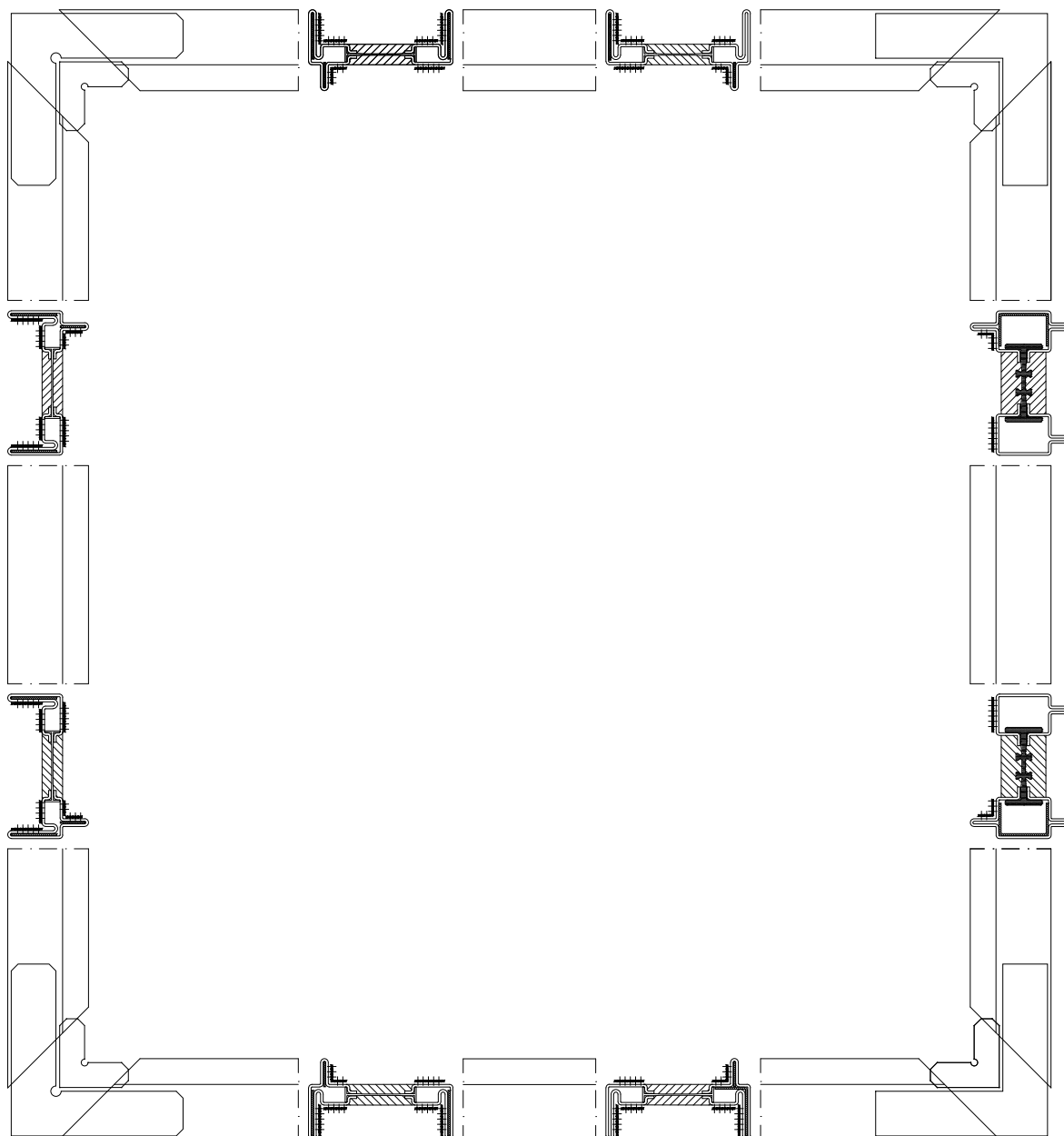
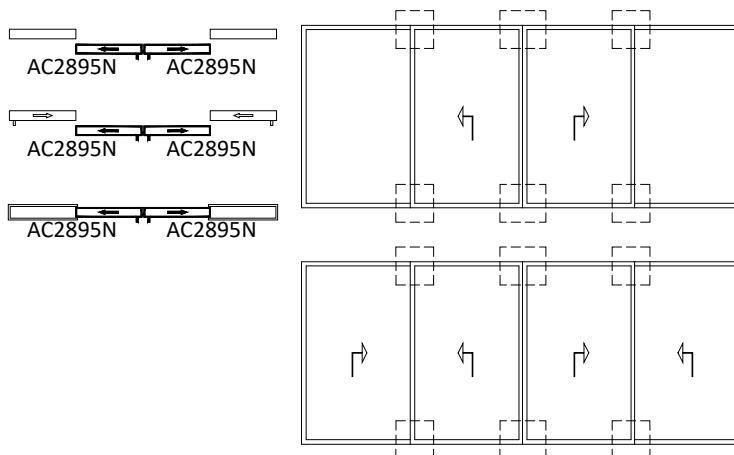

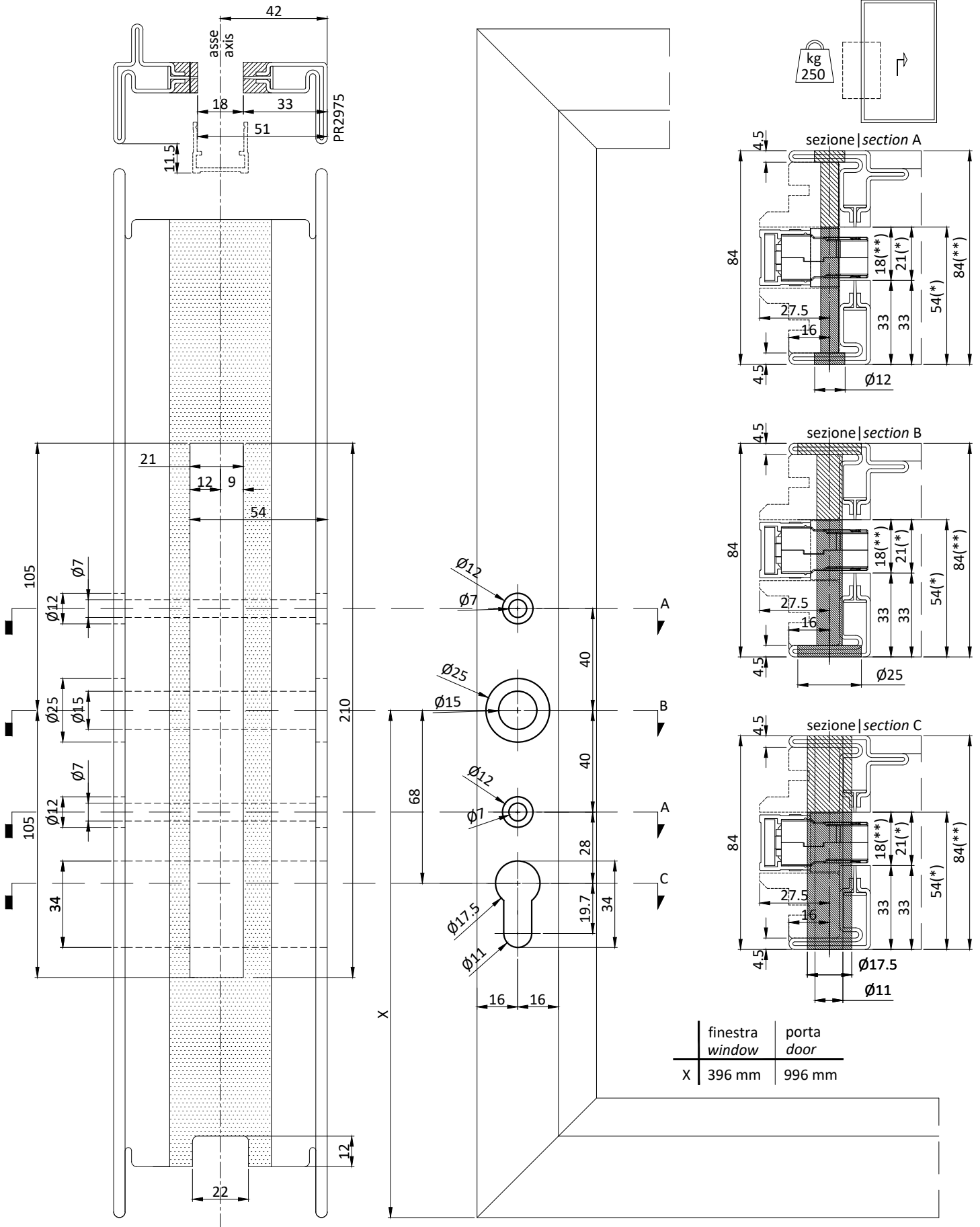

(*) - lavorazione con maniglione singolo | processing with single handle

(**) - lavorazione con maniglione doppio | processing with double handle

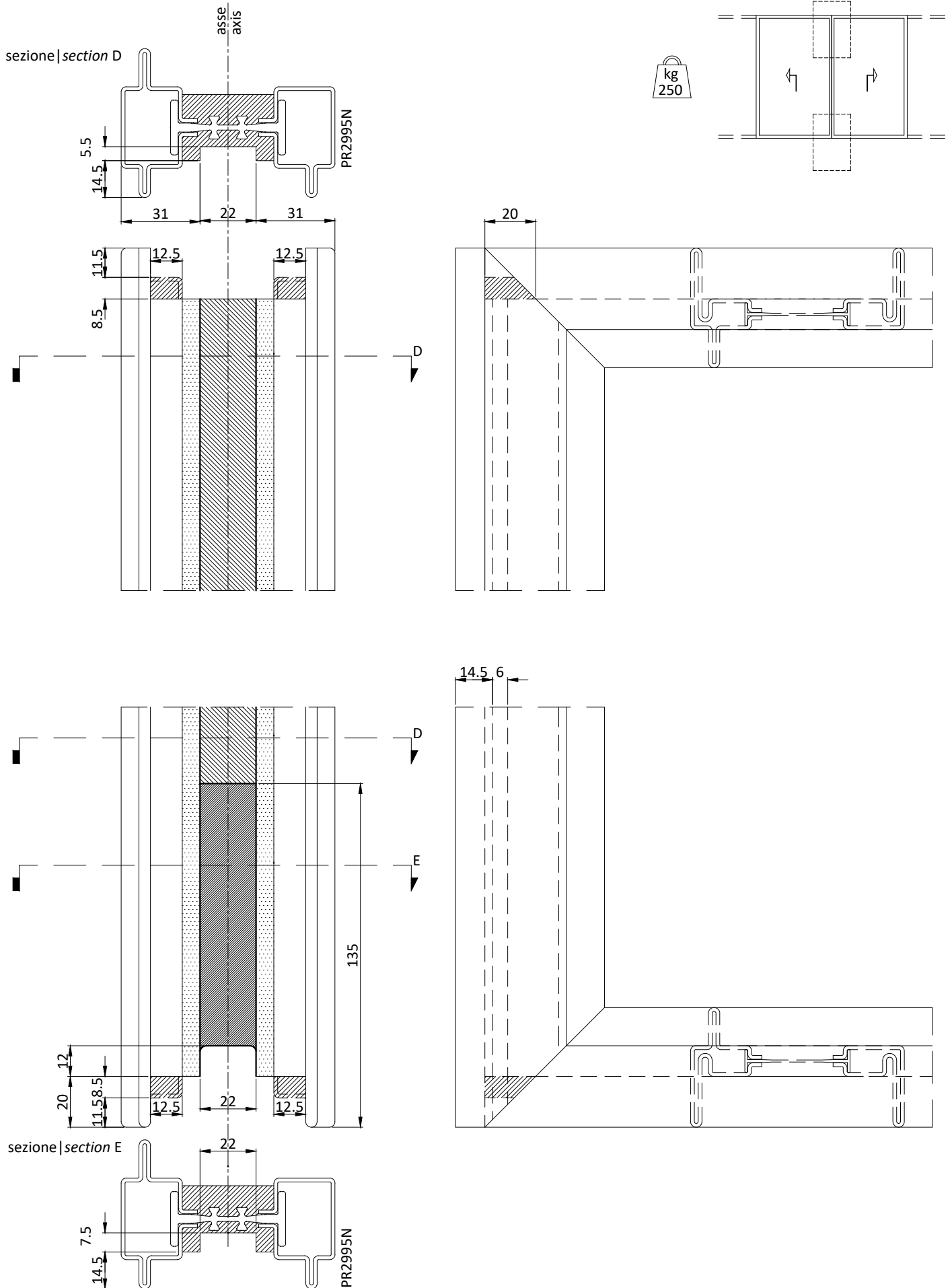

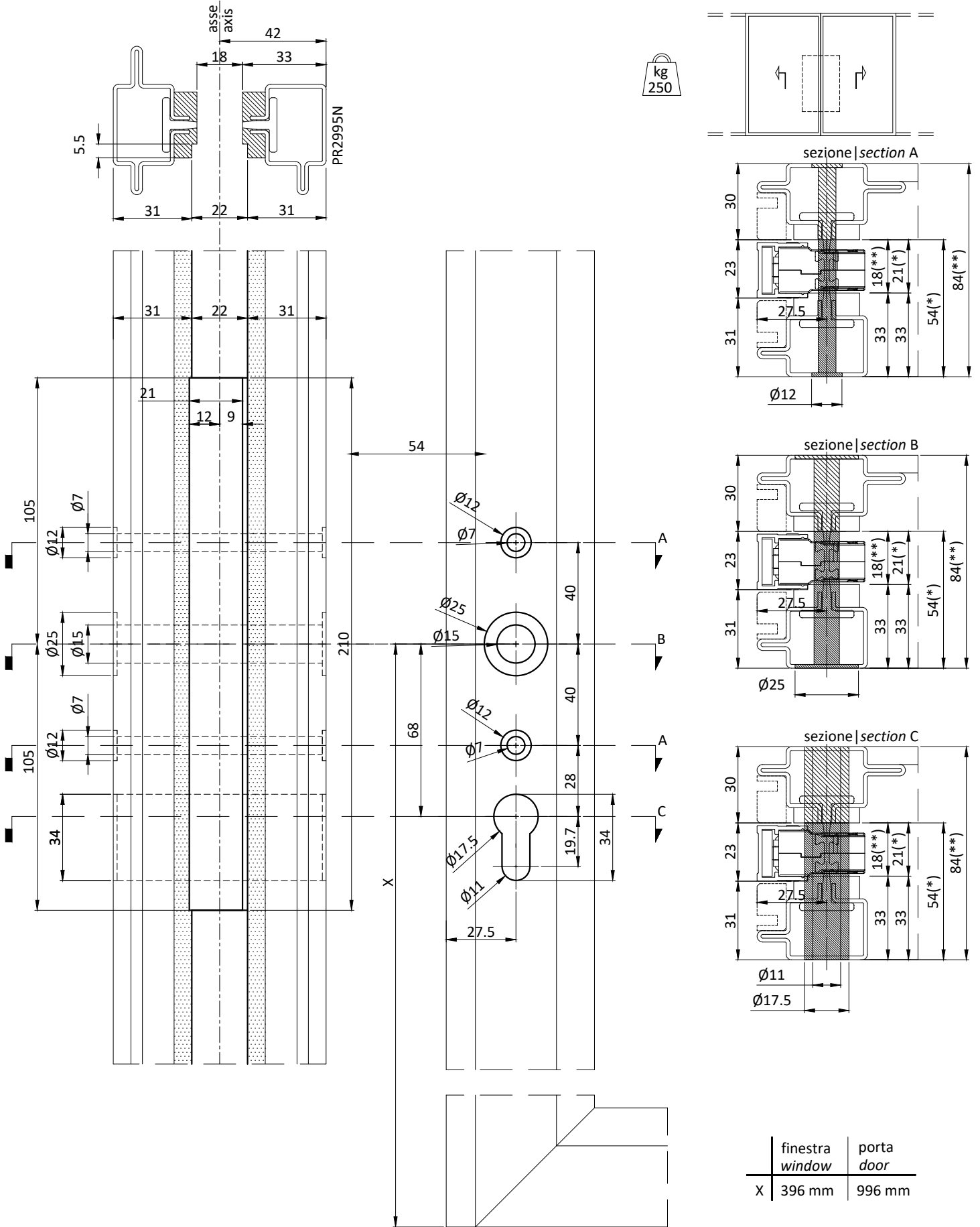

(*) - lavorazione con maniglione singolo | processing with single handle
(**) - lavorazione con maniglione doppio | processing with double handle

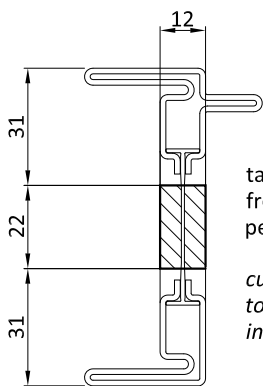
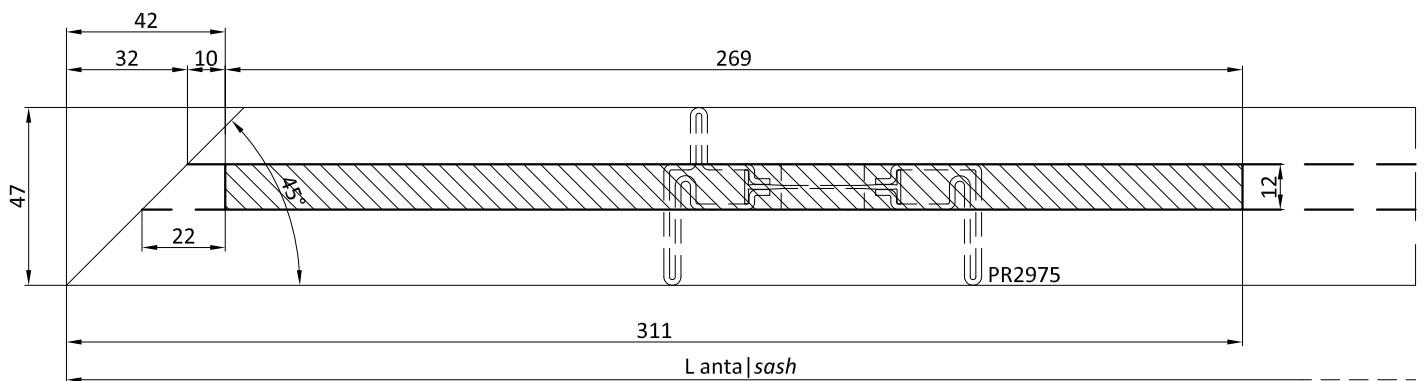
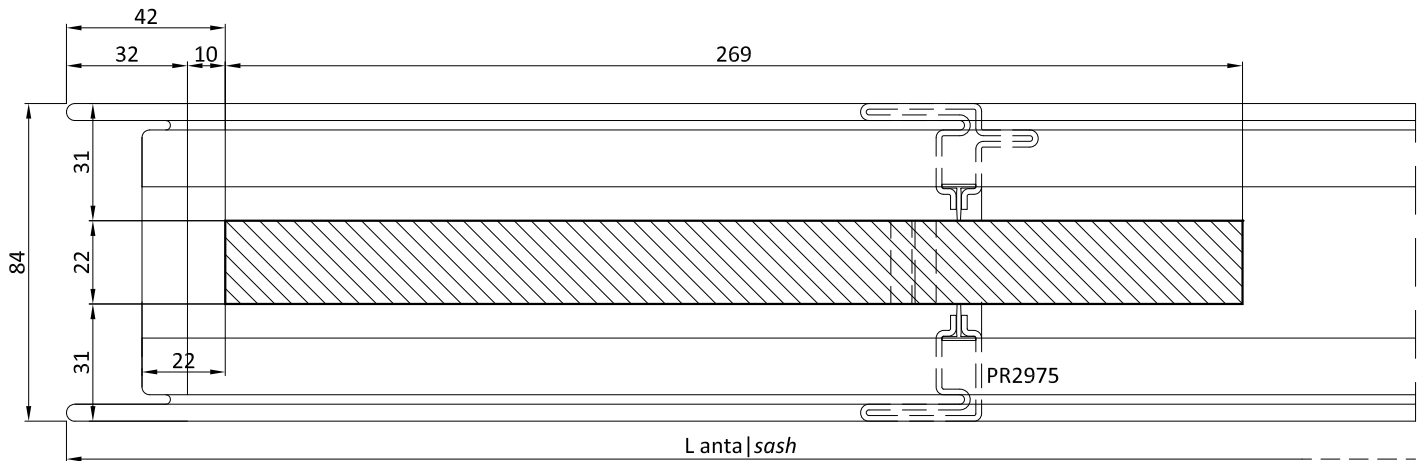
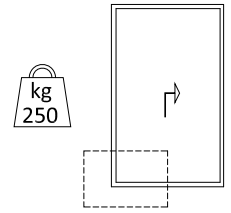

tagliare a misura il profilo PR2975 e
fresare come da disegno il poliuretano
per l'alloggio carrelli

cutting to size the profile PR2975 and
tooling the polyurethane for the trolley
installation as drawing indication

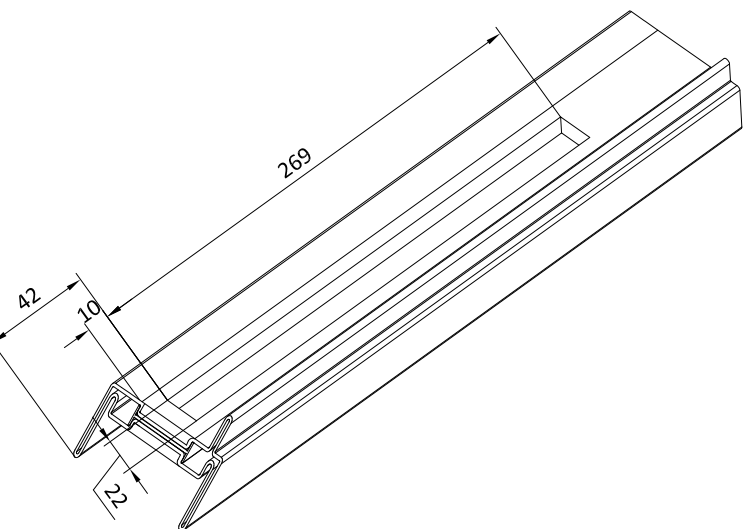

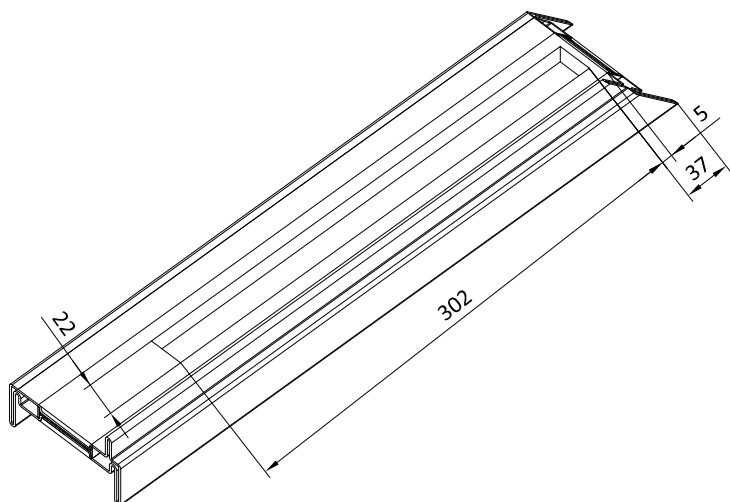
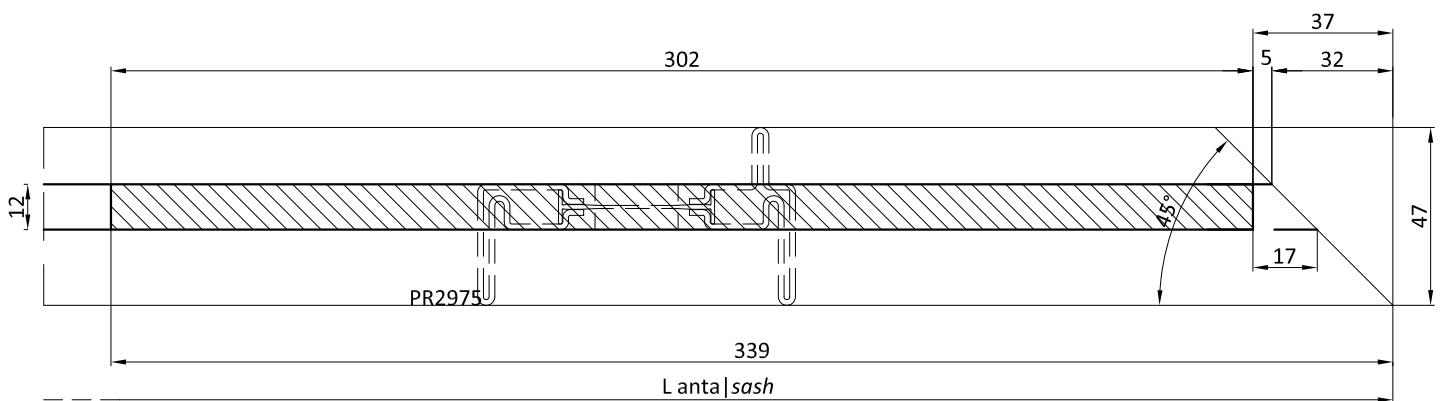
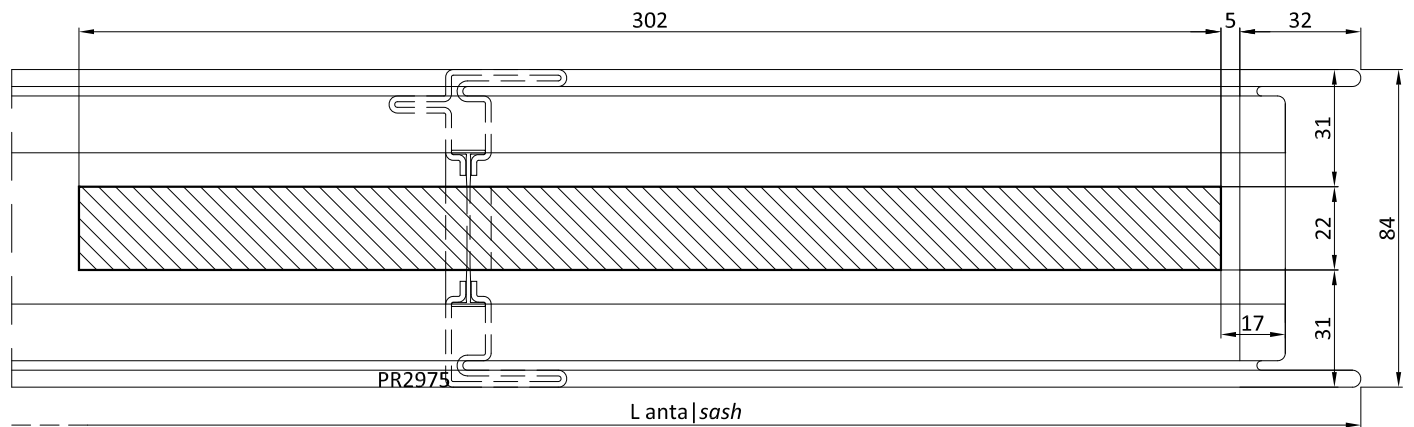
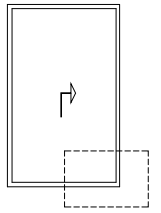

tagliare a misura il profilo PR2975
e fresare come da disegno il poliuretano
per l'alloggio carrelli

cutting to size the profile PR2975 and
tooling the polyurethane for the trolley
installation as drawing indication

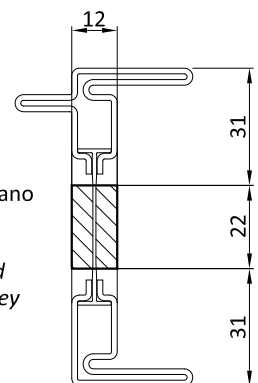

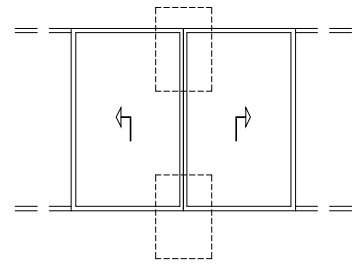
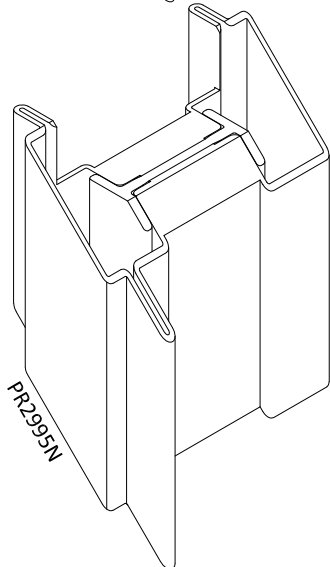
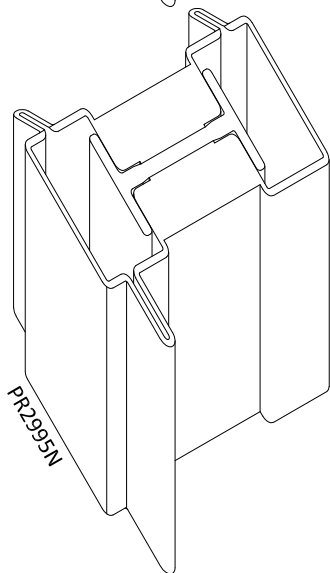
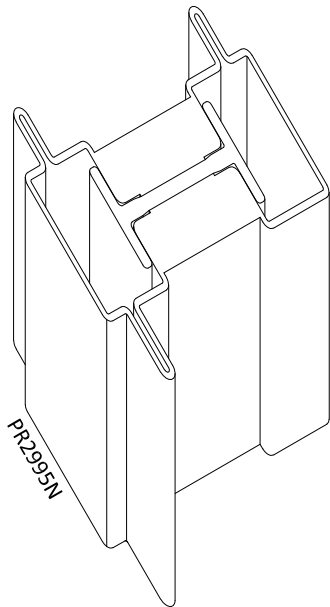

kg
250

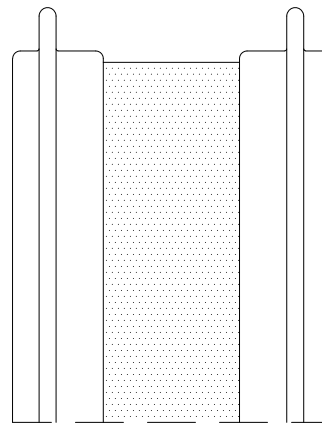
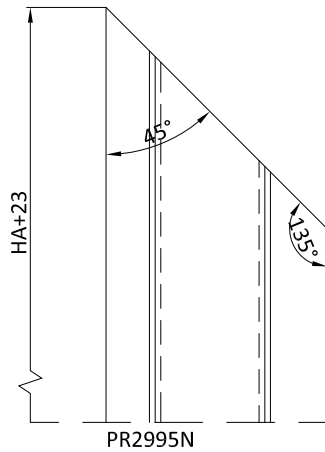

Tagliare a 45° il profilo PR2995N
Cut the PR2995N profile at 45°

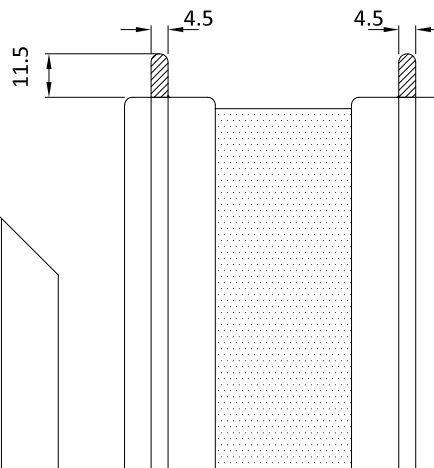
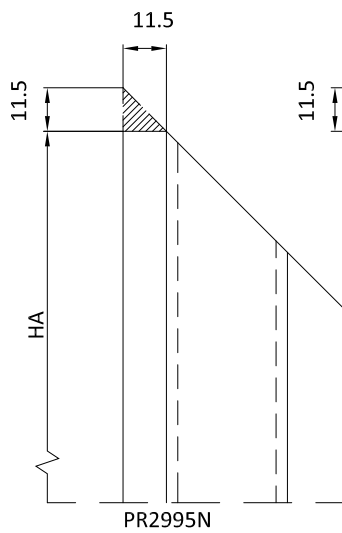

Tagliare le punte in eccesso
Trim excess lips

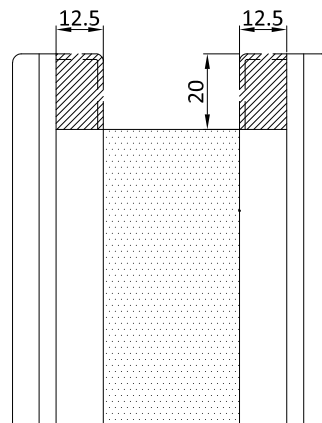
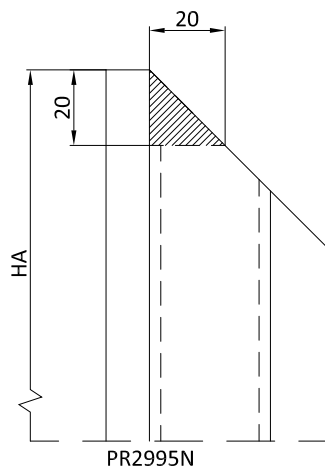

Tagliare le parte interna
Trim the inside part

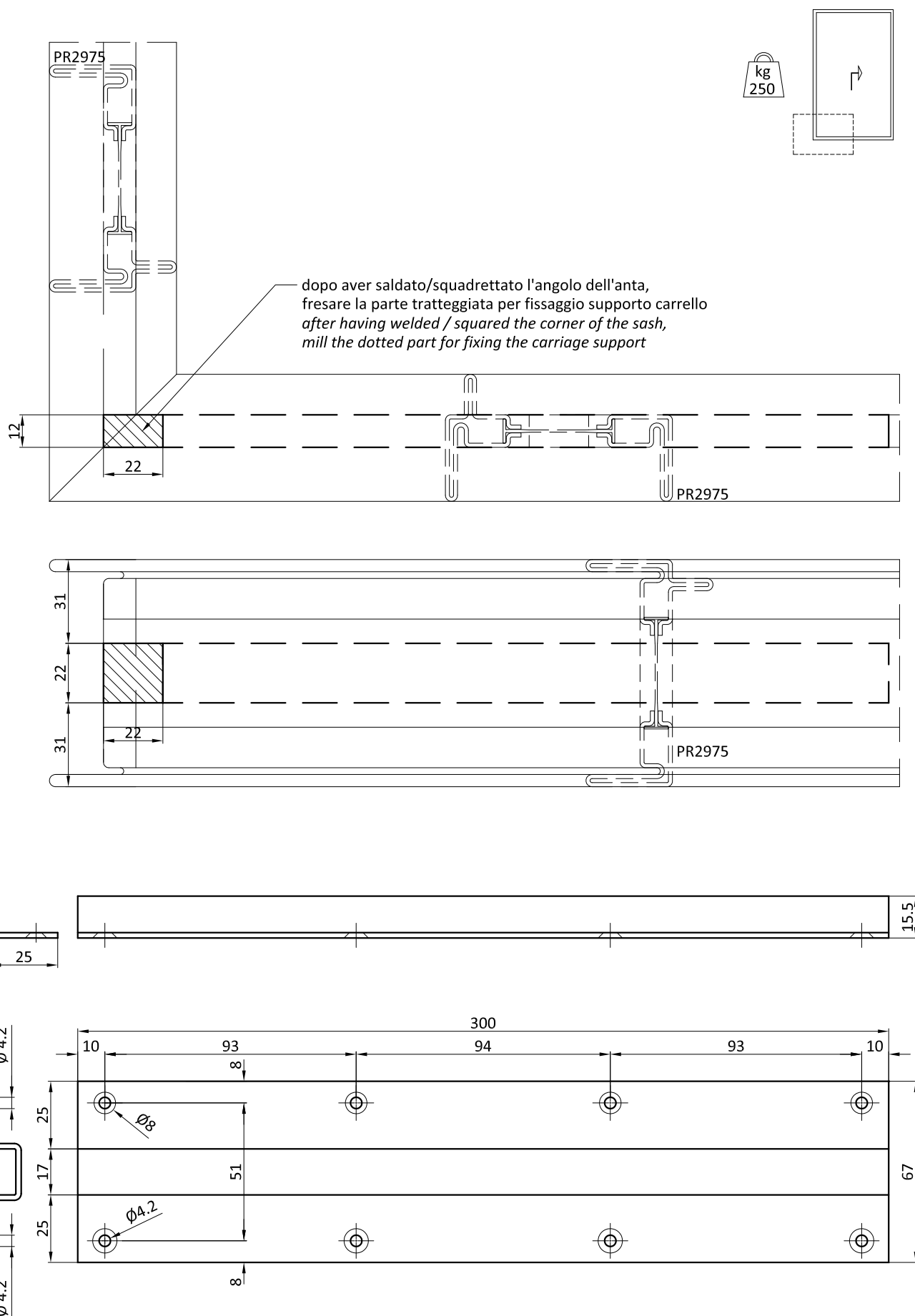

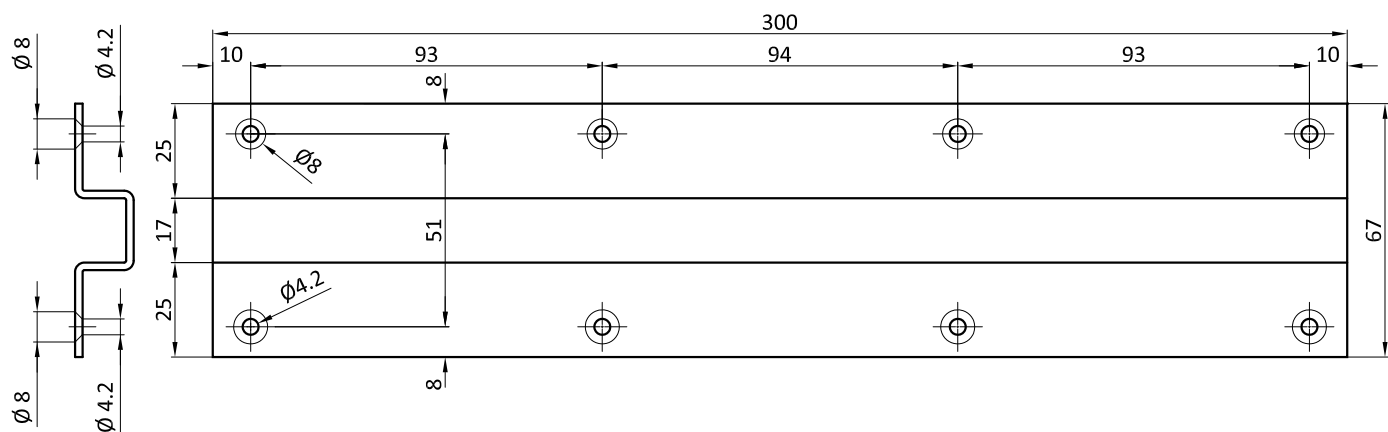
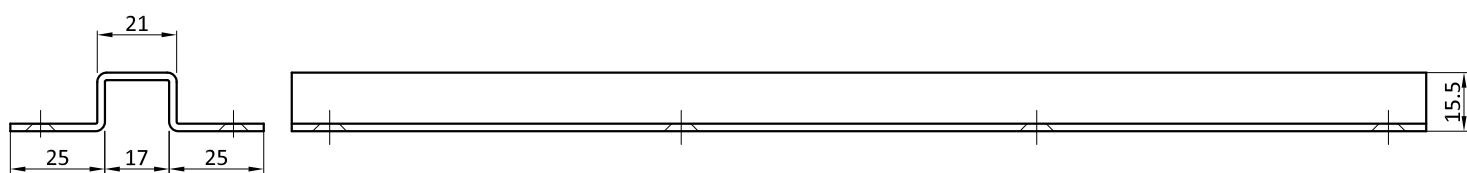
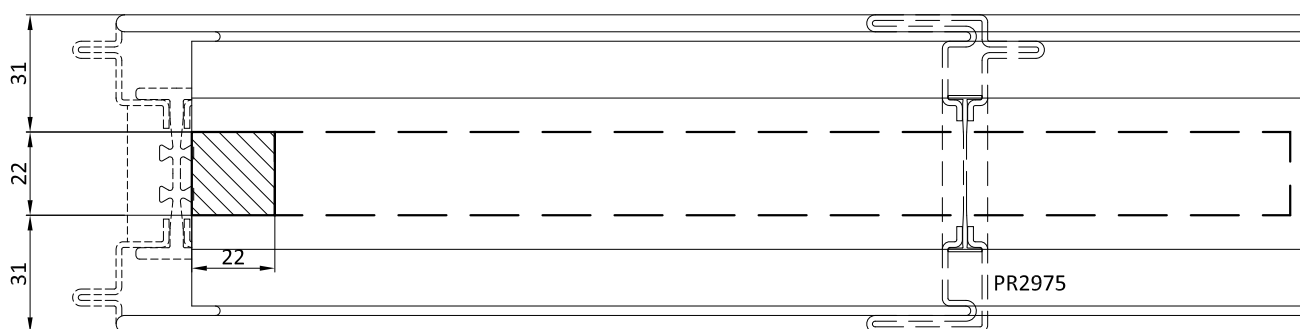
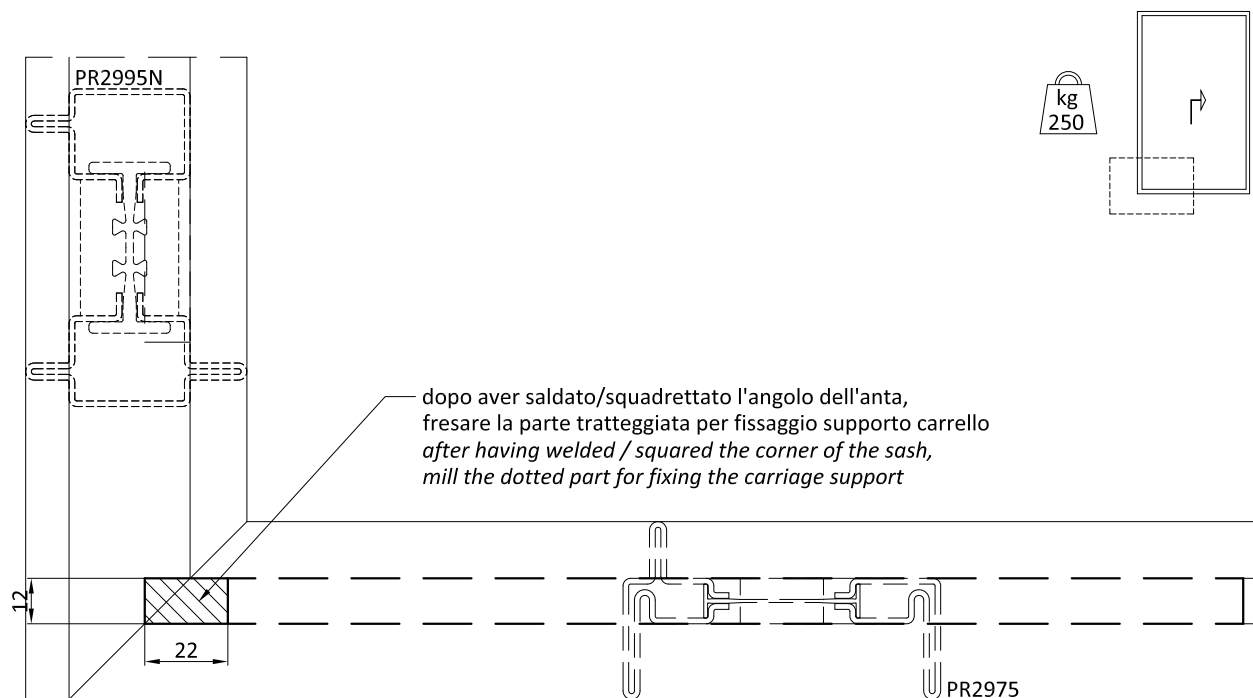

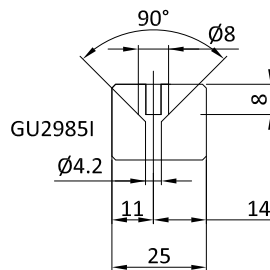
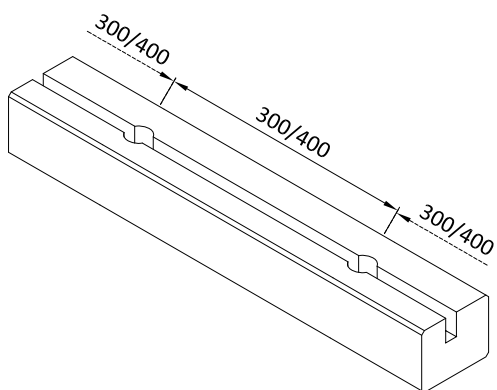
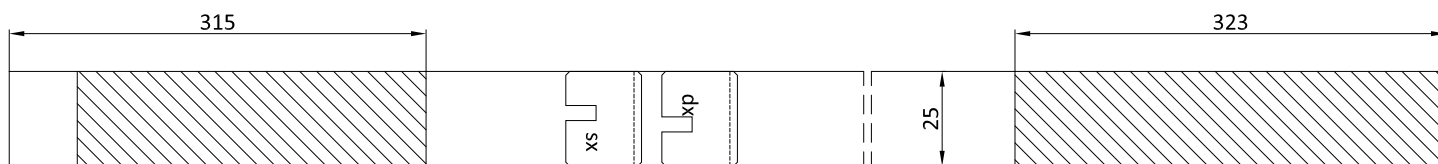
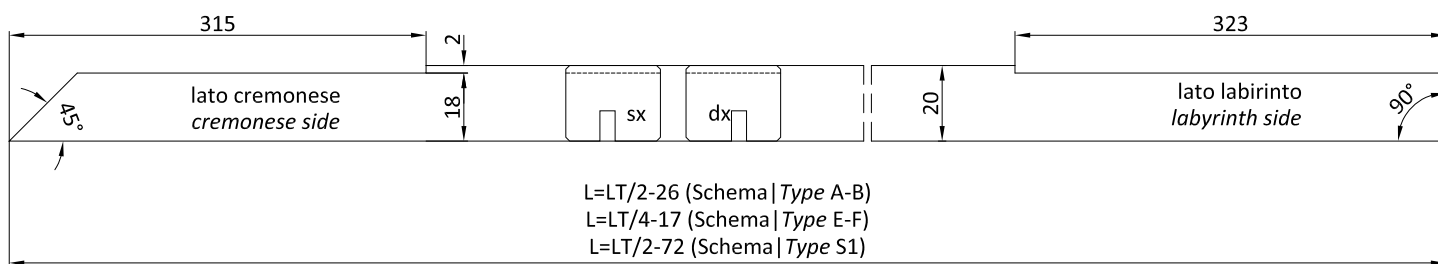
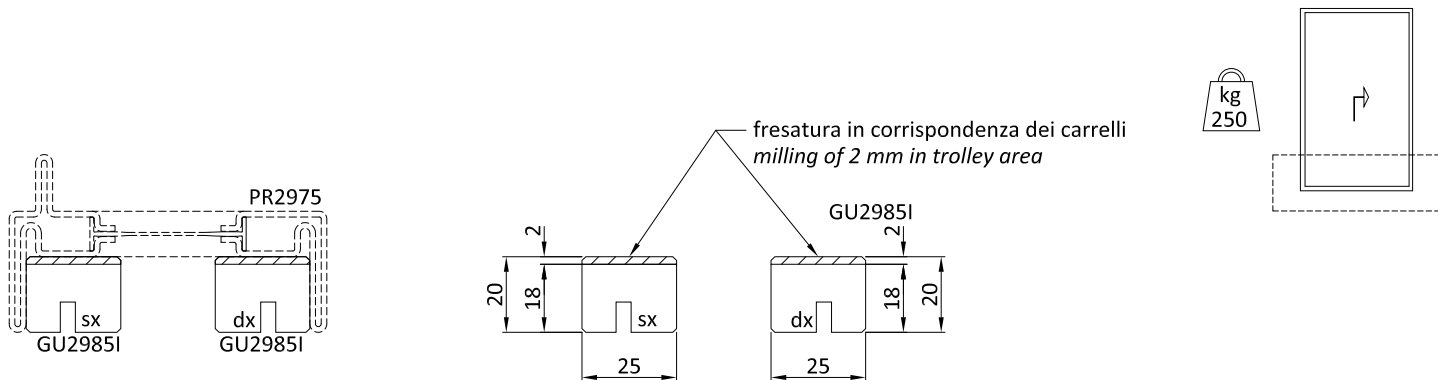

forare Ø4.2 passante
forare Ø8 per 8 mm
svasare per vite M4

drill Ø4.2 through hole
drill Ø8 for 8 mm
countersink for M4 screw

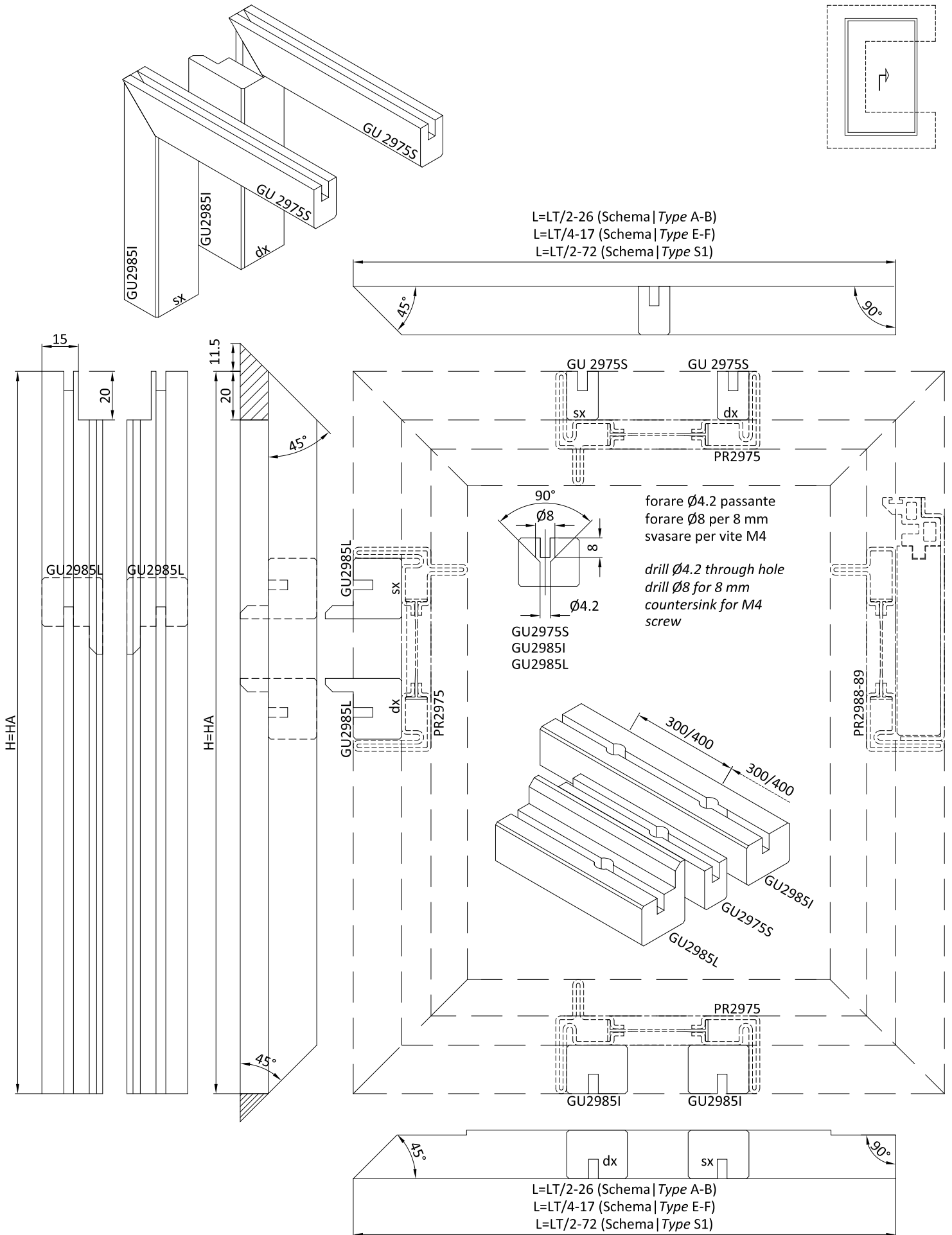

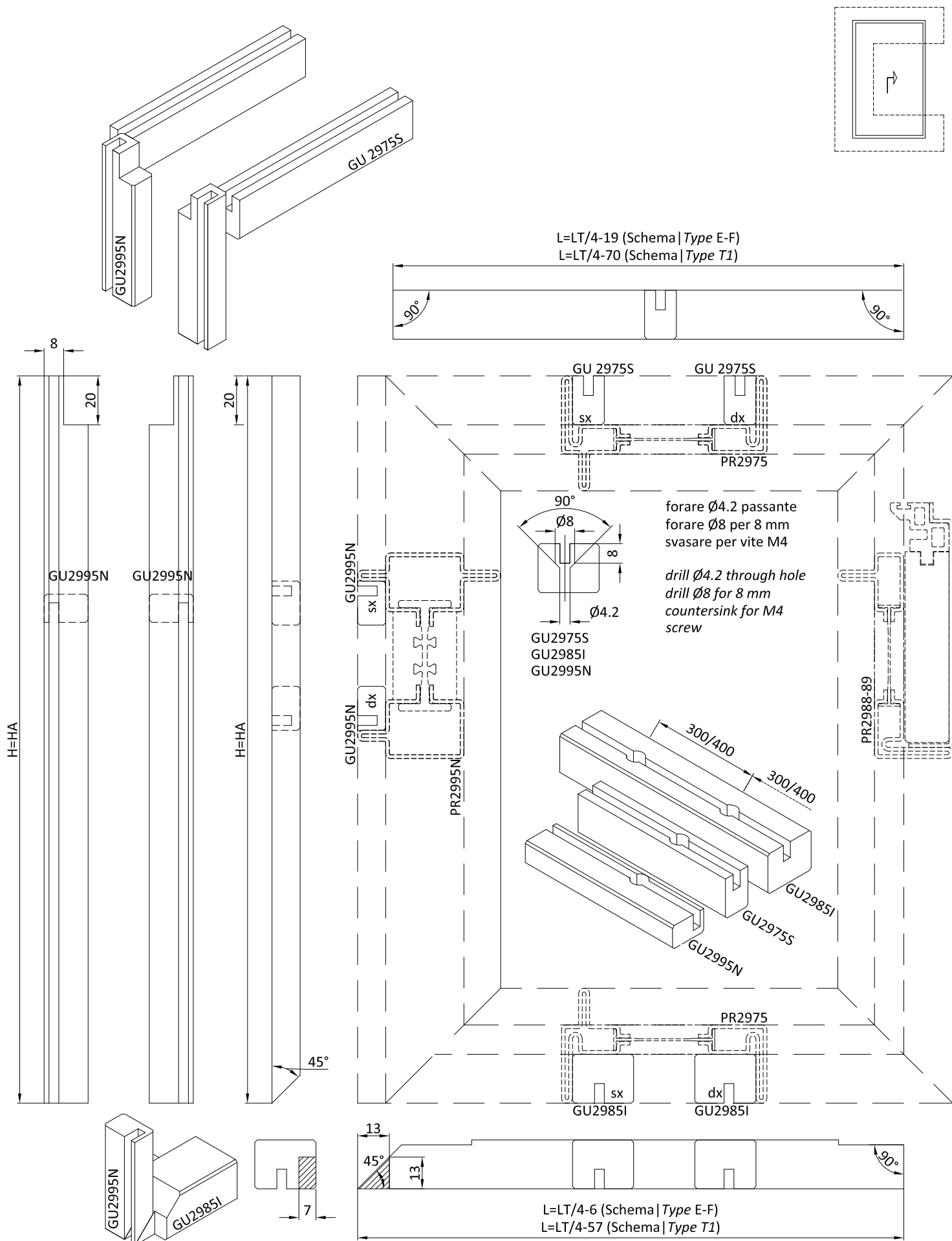

Fissaggio rinforzi parte superiore anta apribile | Fixing upper reinforcements opening sash

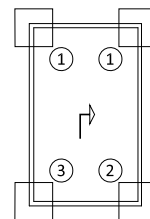
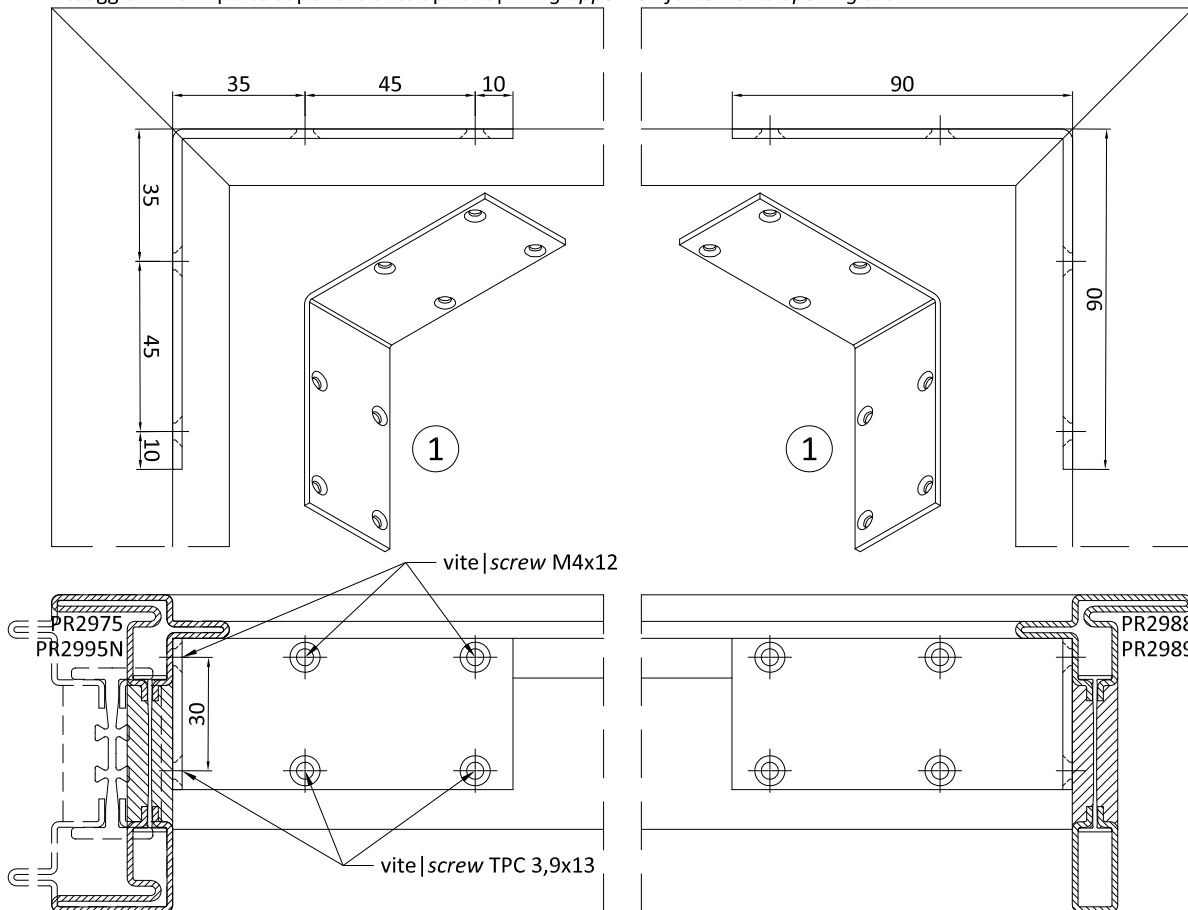

Installare i rinforzi dopo l'assemblaggio delle ante.

Rinforzo tipo 1
2 pezzi

Fissare gli angolari negli angoli interni dell'anta sulla parte superiore

Rinforzo tipo 2
1 pezzo

Fissare l'angolare nell'angolo interno destro dell'anta sulla parte inferiore

Rinforzo tipo 3
1 pezzo

Fissare l'angolare nell'angolo interno sinistro dell'anta sulla parte inferiore

Fissaggio rinforzi parte inferiore anta apribile | Fixing lower reinforcements opening sash

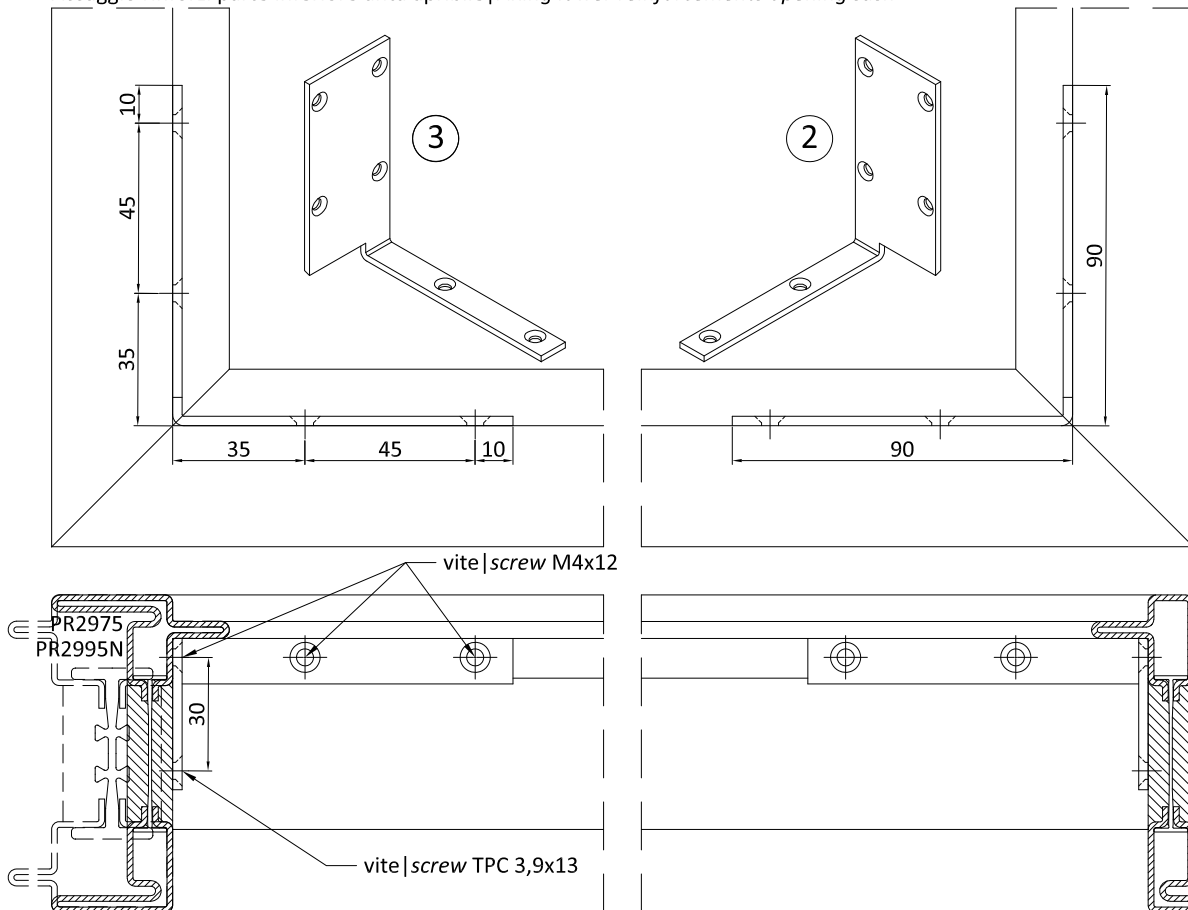

To install reinforcement after the assembly of the sashes.

Reinforcement type 1
2 pieces

Fix the corner pieces in the inner corners of the sash on the top

Reinforcement type 2
1 piece

Fix the angle in the inner right corner of the sash on the lower part.

Reinforcement type 2
1 piece

Fix the angle in the inner left corner of the sash on the lower part

PR2989
PR2988 * viti non comprese
* screws not supplied

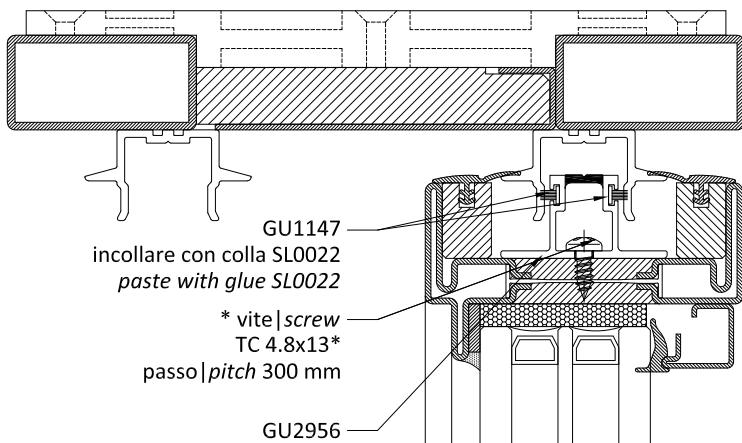

Schema | Type A

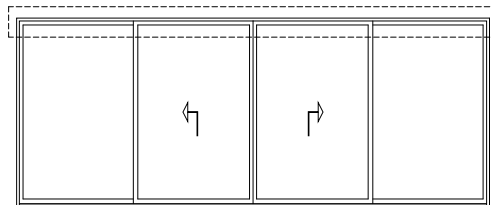
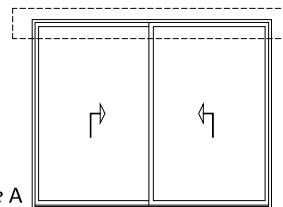

Schema | Type E

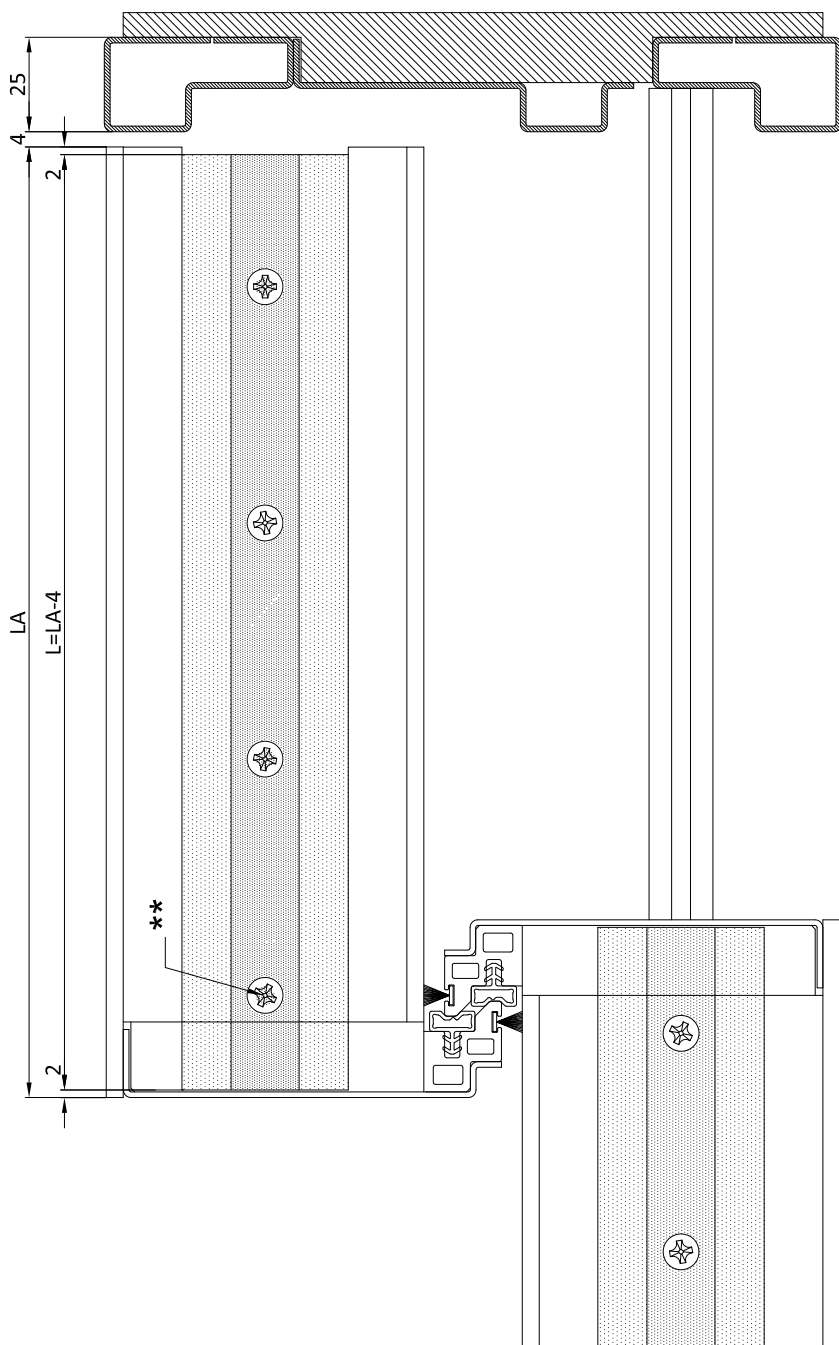

GU2956

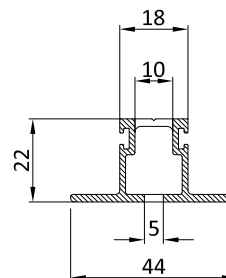
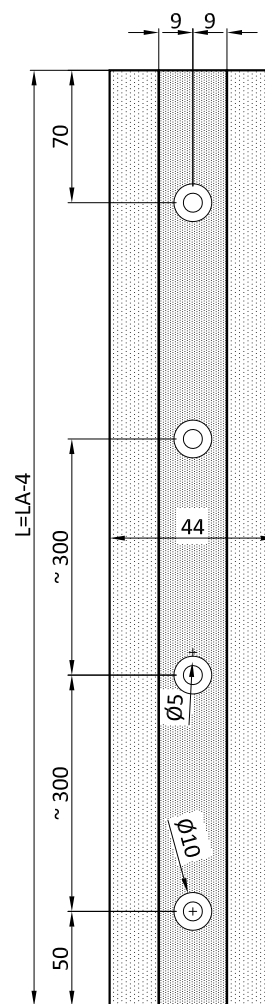

* viti TC 4.8x13 non comprese | screws TC 4.8x13 not supplied

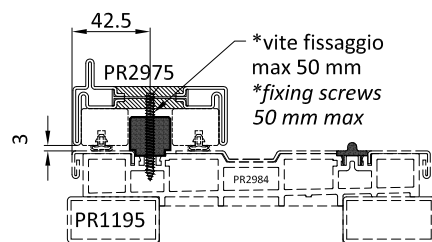
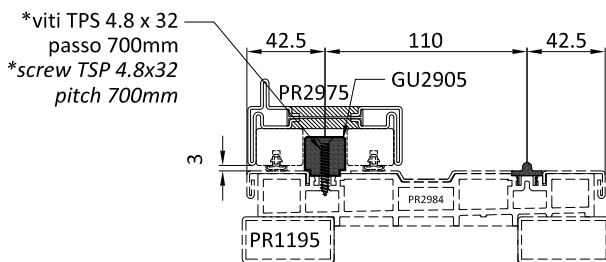
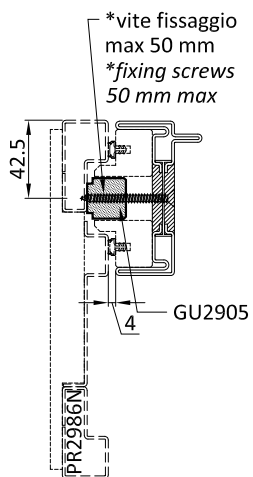
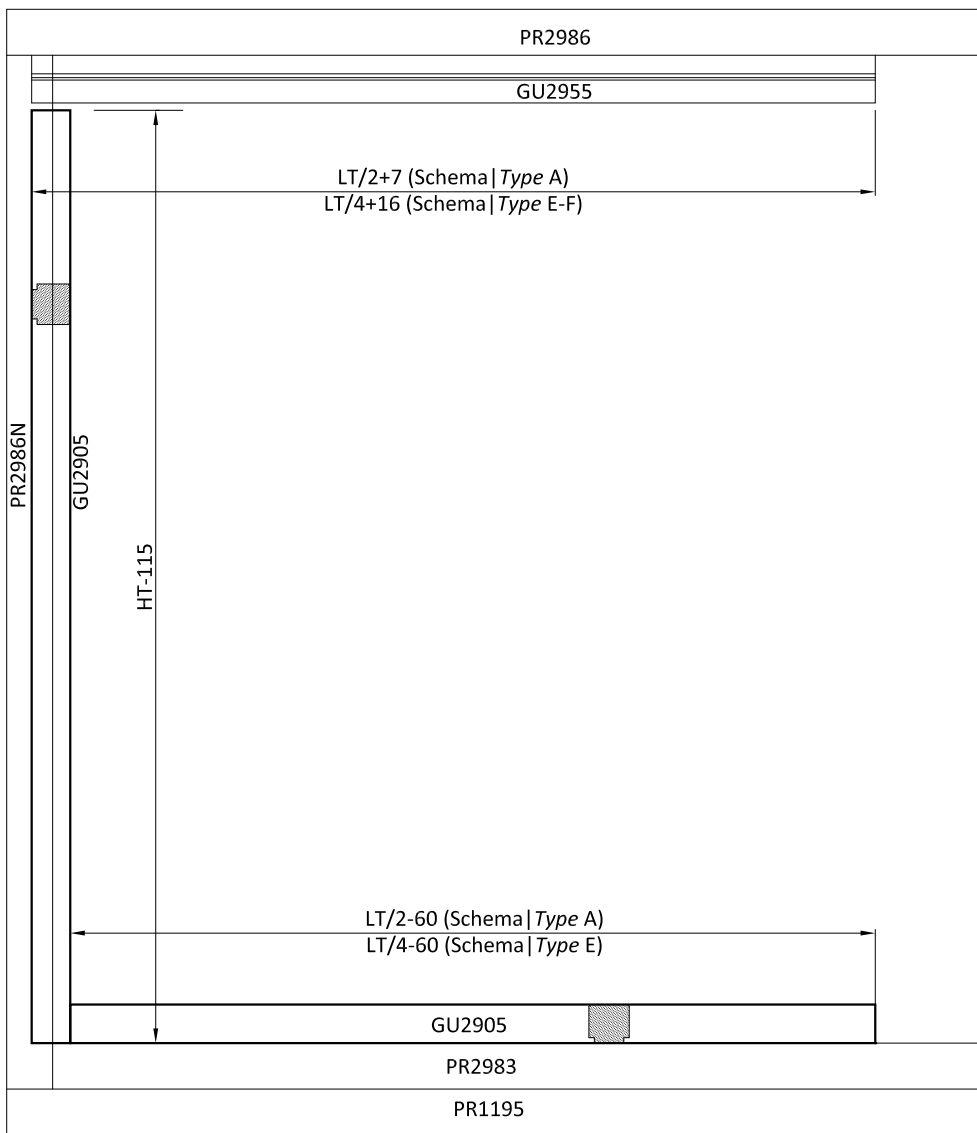
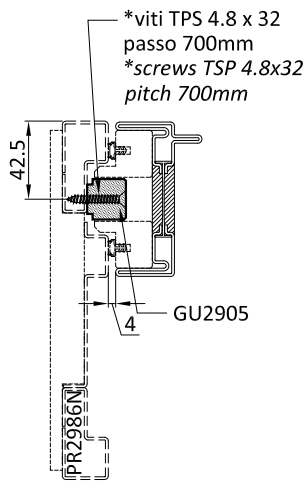
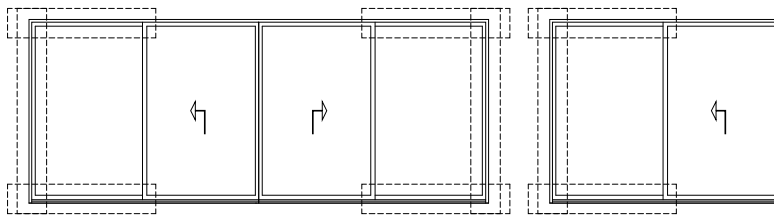
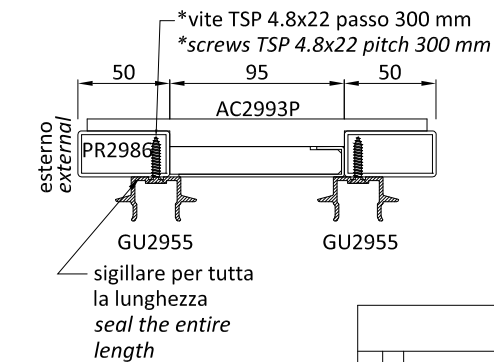

non comprese
is not supplied

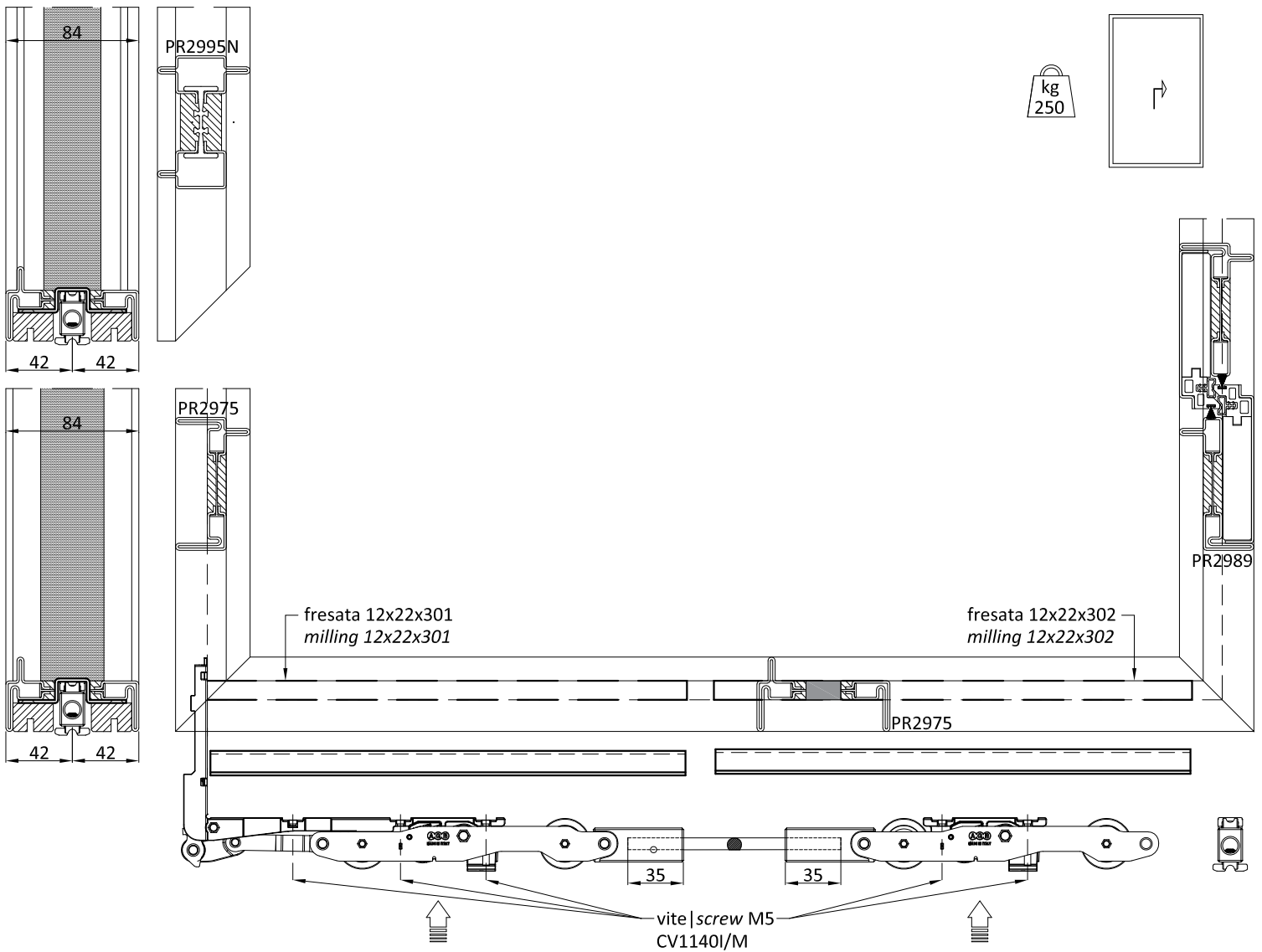

profilo supporto
carrelli
bogie support
profile

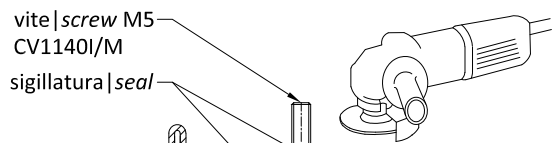
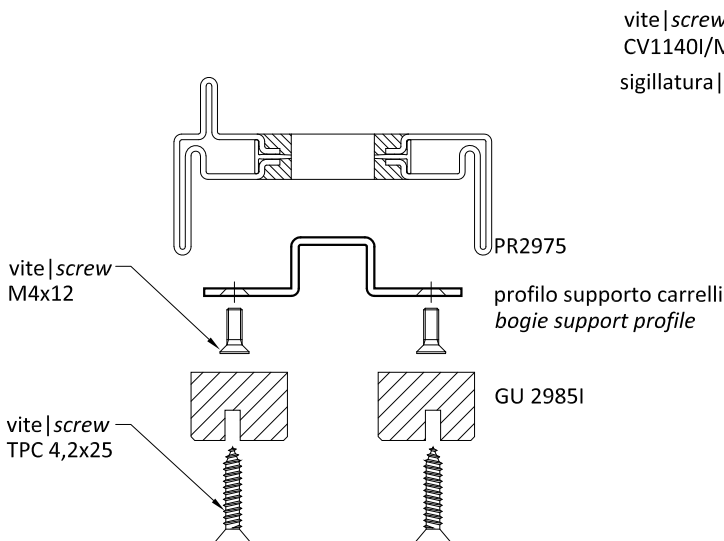
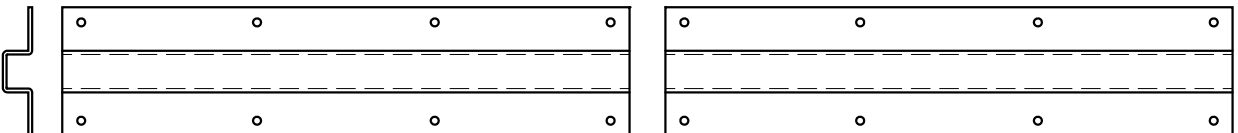

Sequenza installazione | Installing sequence:

- 1-Fissare il profilo di supporto carrelli al profilo PR2975
Fix the bogie support profile to PR2975
- 2-Sigillare il profilo di supporto su tutto il perimetro
Seal the gap between PR2975 and support profile
- 3-Fissare il carrello al profilo di supporto
Fix bogie on the support profile
- 4-Tagliare la vite CV1140I/M in eccedenza
Cut screw CV1140I/M over the profile

viti M4x12, TPC 4,2x25 non comprese - CV1140I/M fornita con il kit
M4x12, TPC 4,2x25 screws not supplied - CV1140I/M supplied with kit



1) Profilo metallico | *Metallic profile*

2) Estruso in PVC rigido | *Extruded PVC profile*

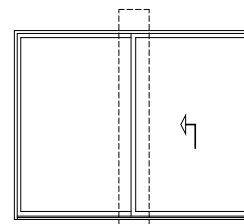
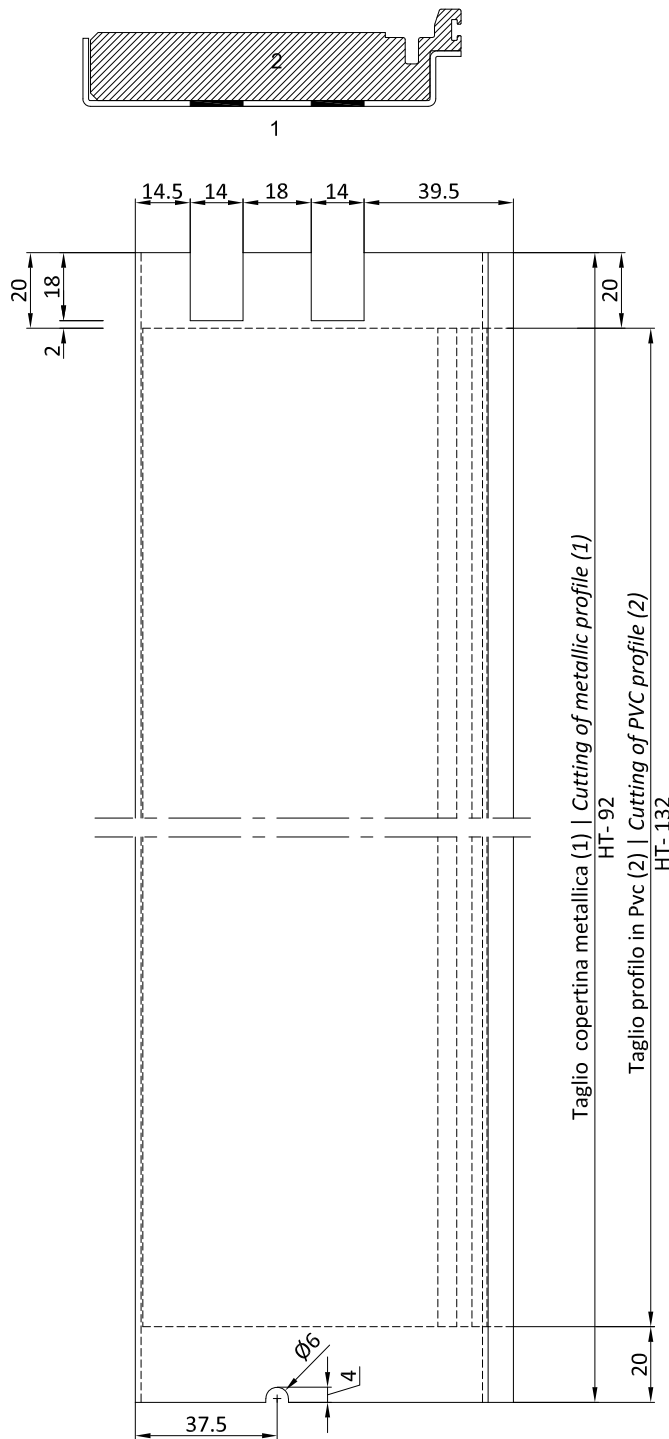

Schema | Type A

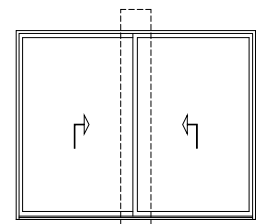

Schema | Type B

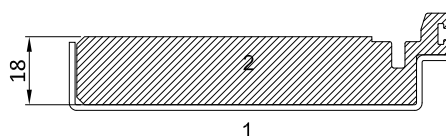
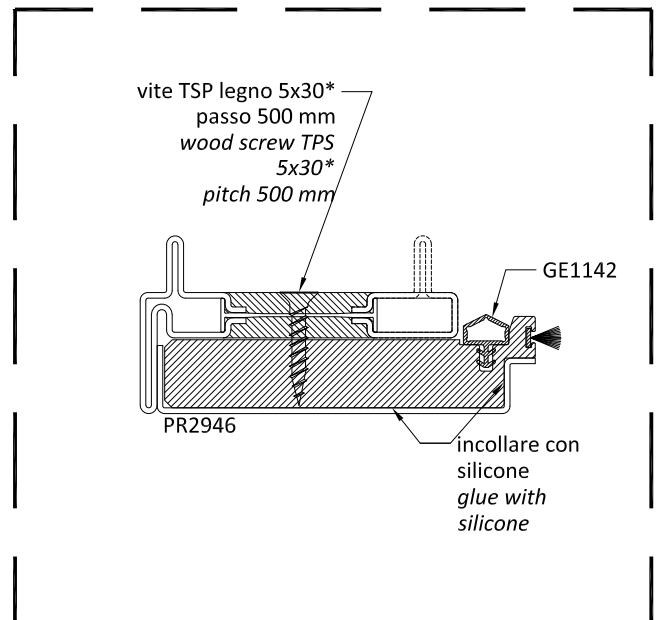
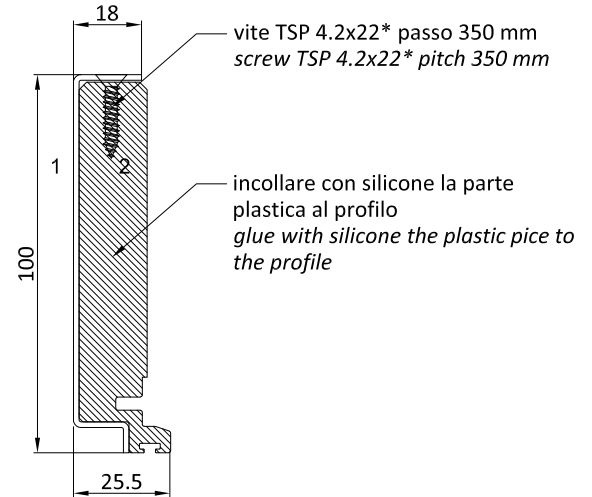

* viti TPS 4.2 x 22 e TC legno 6x35 non comprese
* TPS 4.2 screws x 22 and wood screws TC 6x35 not supplied

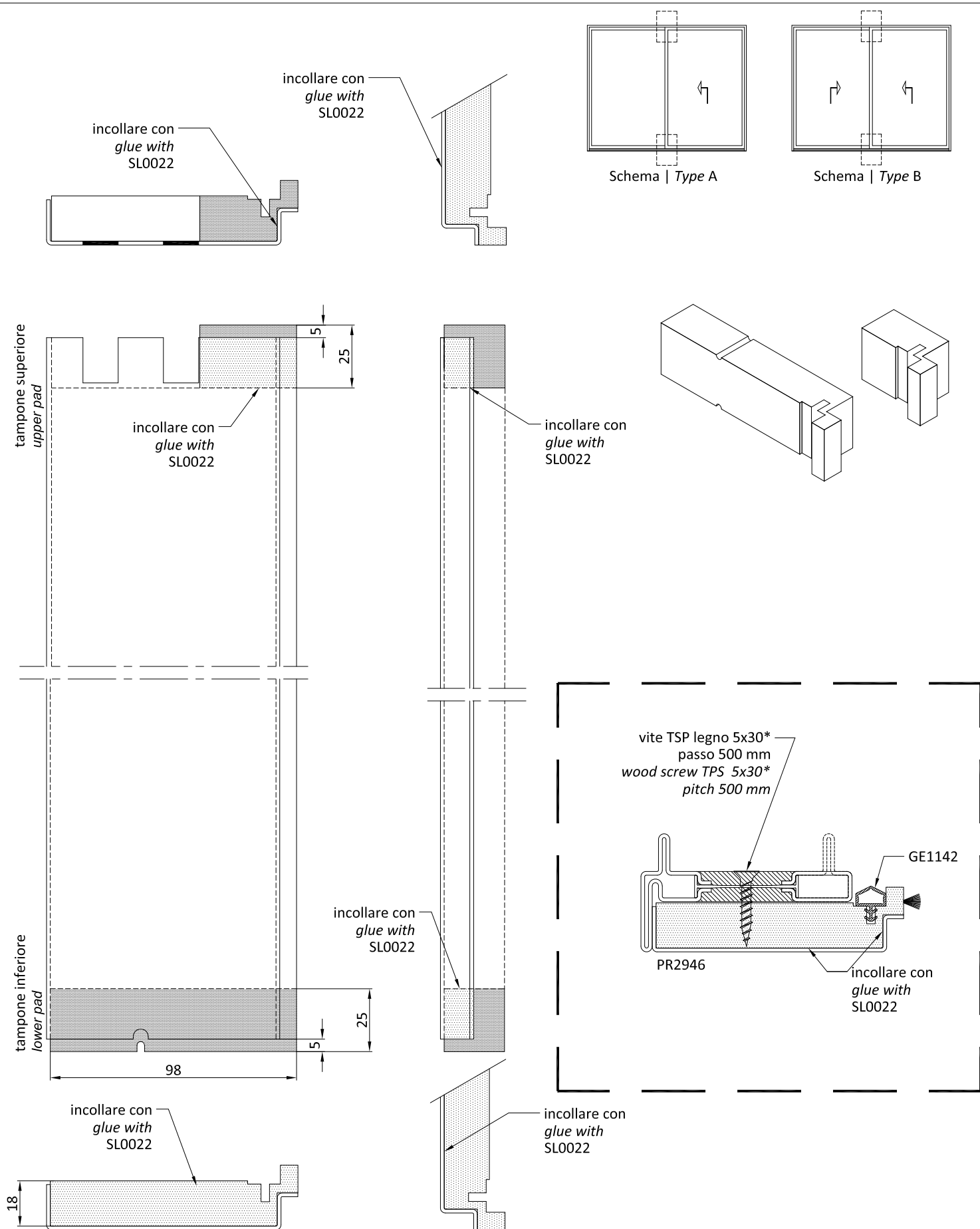

1) Profilo metallico | *Metallic profile*

2) Estruso in PVC rigido | *Extruded PVC profile*

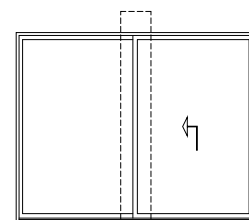

Schema | Type A

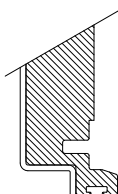
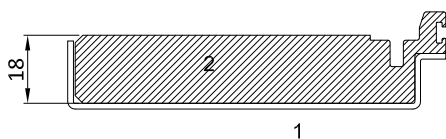
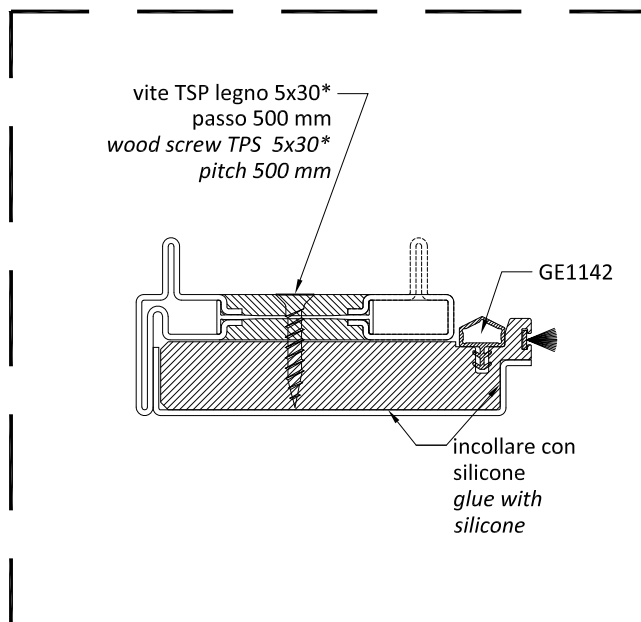
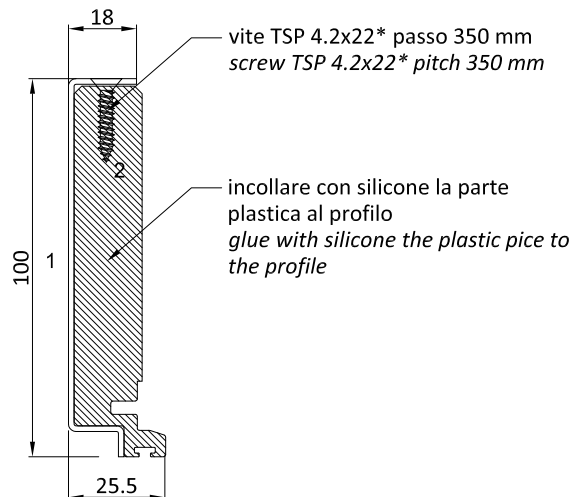
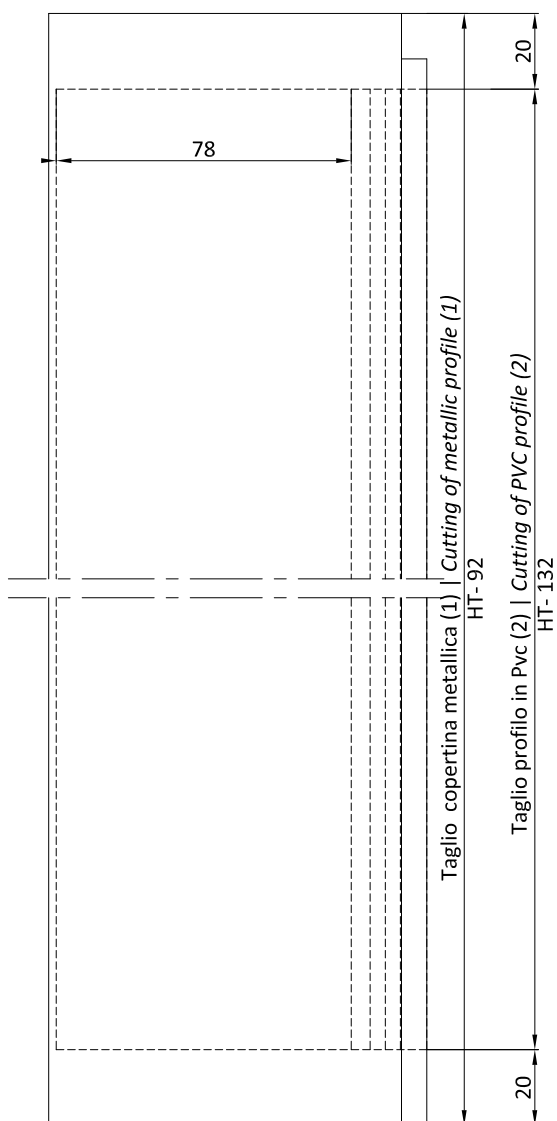
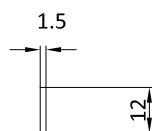
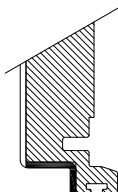
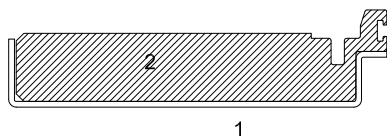

* viti TPS 4.2 x 22 e TC legno 6x35 non comprese
* *TPS 4.2 screws x 22 and wood screws TC 6x35 not supplied*

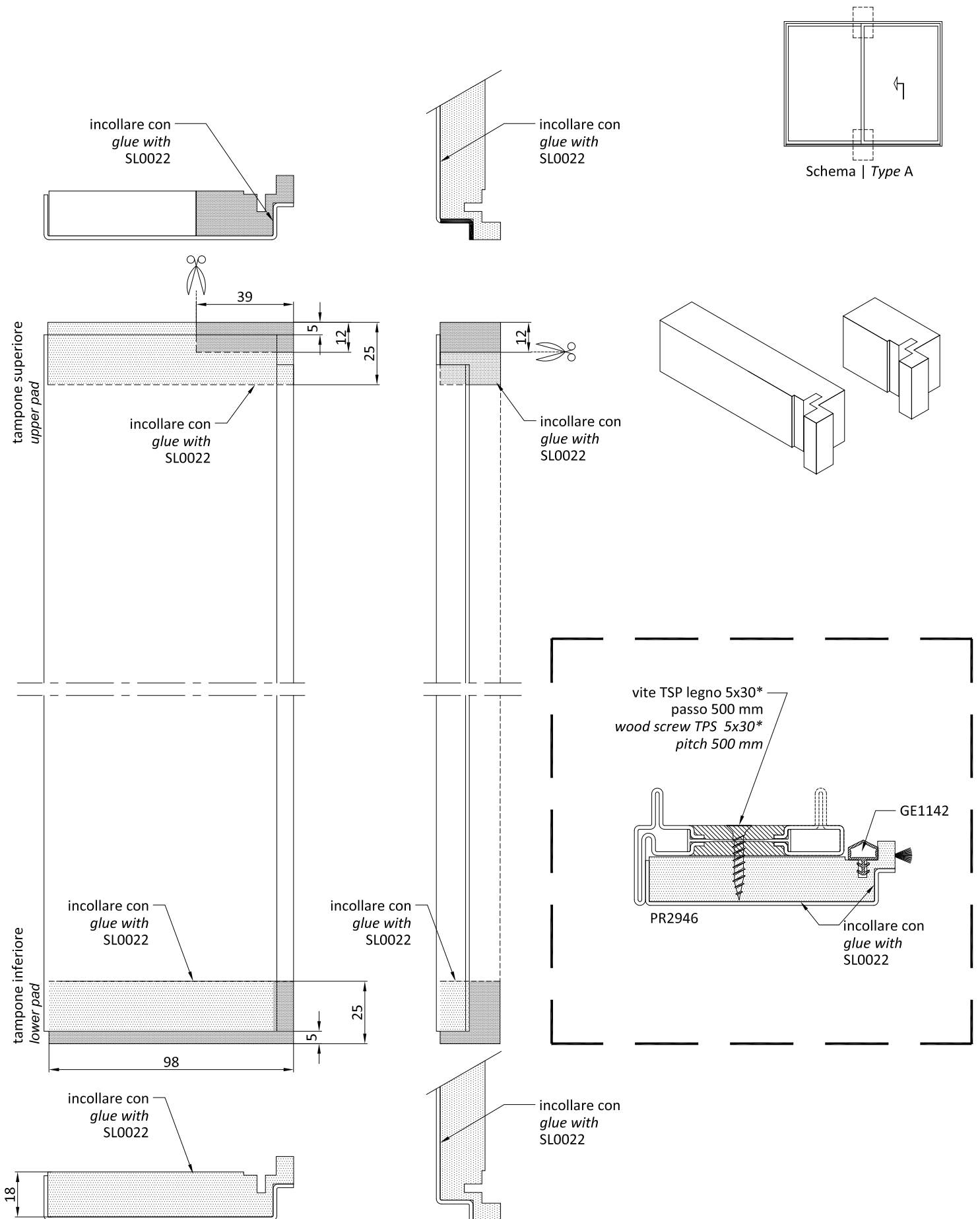

Schema | Type A - B

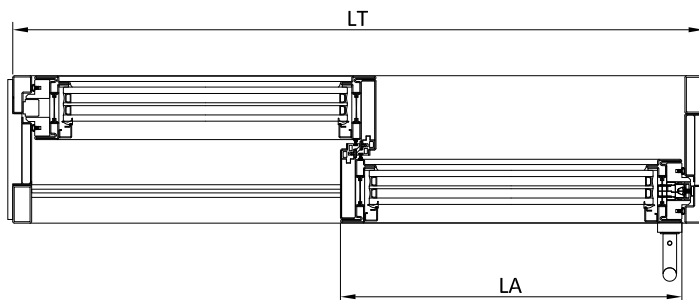
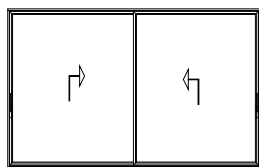

Dimensione anta (A)
Sash dimension (A)

$$LA = LT/2 - 6$$

$$HA = HT - 92$$

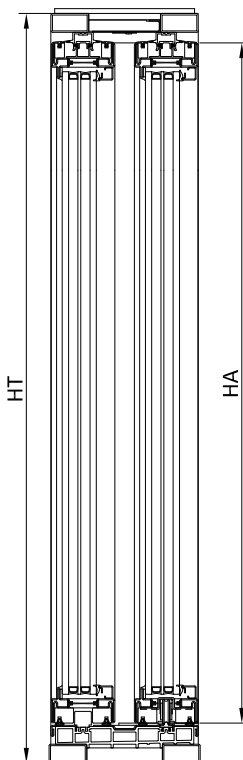

Schema | Type E - F

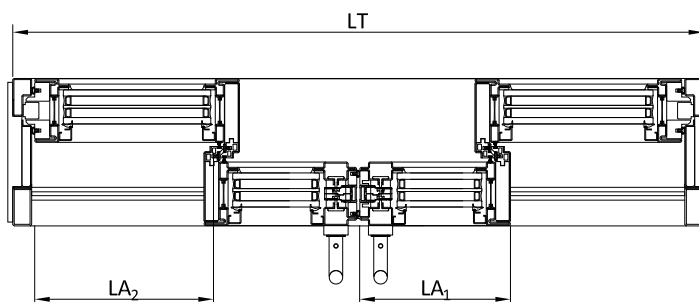
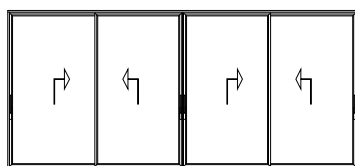

Dimensione anta (A)
Sash dimension (A)

$$LA_1 = LT/4 + 13$$

$$LA_2 = LT/4 + 3$$

$$HA = HT - 92$$

$$HA = HT - 92$$

Schema | Type S1

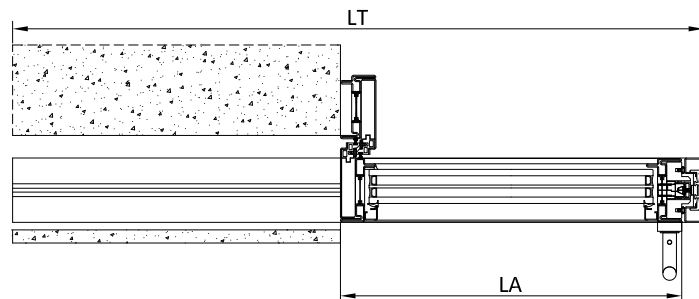
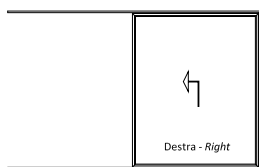

Dimensione anta (A)
Sash dimension (A)

$$LA = LT/2 - 52$$

$$HA = HT - 92$$

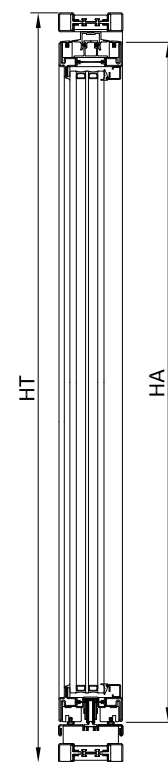

Schema | Type T1

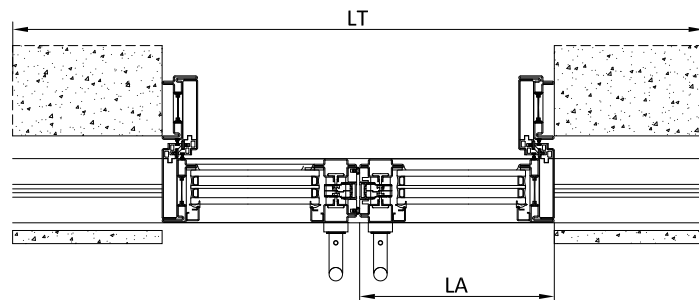
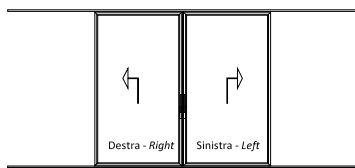

Dimensione anta (A)
Sash dimension (A)

$$LA = LT/4 - 38$$

$$HA = HT - 92$$

Schema | Type A

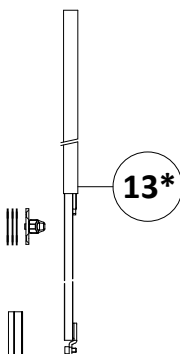
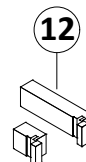
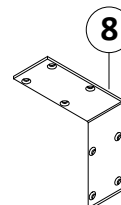
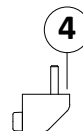
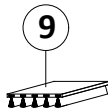
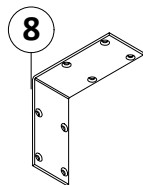
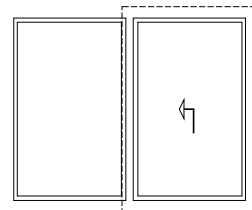

AG2986-7A - DESCRIZIONE DESCRIPTION AG2986-7A		
1	Carrello anteriore	Front carriage
2	Carrello posteriore	Rear carriage
3	Rostro di chiusura	Locking pin
4	Fermo anta	Bumper stop
5	Barra di unione	Stopper
6	Meccanismo	Mechanism
7	Profilo omega per fissaggio carrelli	Reinforcement profile for fixing carriage
8	Kit rinforzo angoli	Kit reinforcement
9	Tampone centrale di tenuta su guida sup.	Central sealing pad for upper rail
10	Tampone centrale di tenuta su guida inf.	Central sealing pad for bottom rail
11	Tampone di tenuta in neoprene	Neoprene sealing pads
12	Tampone di tenuta in neoprene	Neoprene sealing pads
13*	Prolunga meccanismo	Additional mechanism
14	Vite fissaggio carrelli (CV1140I/M)	Carriage fixing screw (CV1140I/M)

* Presente solo su kit AG2986-7B.E1
Only on the kit AG2986-7B.E1

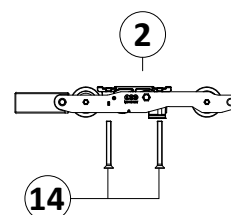
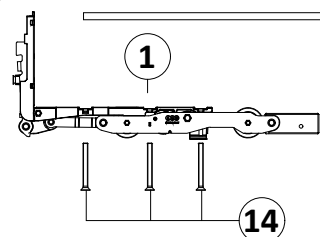
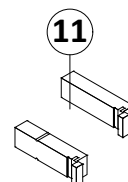
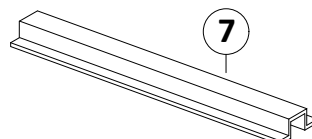
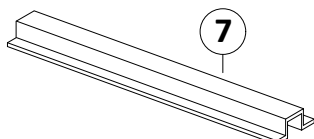
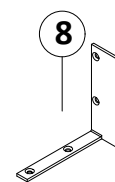
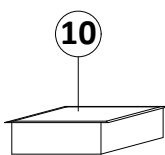
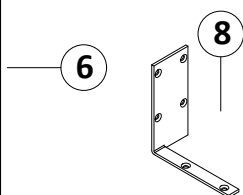

Schema | Type B

kg
250

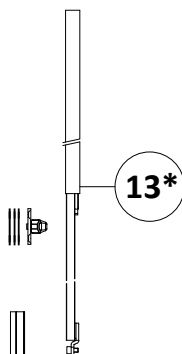
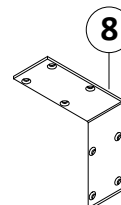
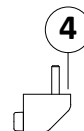
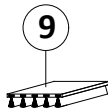
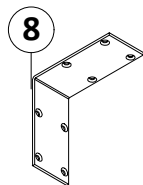
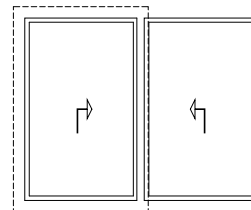

AG2986-7B - DESCRIZIONE DESCRIPTION AG2986-7B		
1	Carrello anteriore	Front carriage
2	Carrello posteriore	Rear carriage
3	Rostro di chiusura	Locking pin
4	Fermo anta	Bumper stop
5	Barra di unione	Stopper
6	Meccanismo	Mechanism
7	Profilo omega per fissaggio carrelli	Reinforcement profile for fixing carriage
8	Kit rinforzo angoli	Kit reinforcement
9	Tampone centrale di tenuta su guida sup.	Central sealing pad for upper rail
10	Tampone centrale di tenuta su guida inf.	Central sealing pad for bottom rail
11	Tampone di tenuta in neoprene	Neoprene sealing pads
12	Tampone di tenuta in neoprene	Neoprene sealing pads
13*	Prolunga meccanismo	Additional mechanism
14	Vite fissaggio carrelli (CV1140I/M)	Carriage fixing screw (CV1140I/M)

* Presente solo su kit AG2986-7B.E1
Only on the kit AG2986-7B.E1

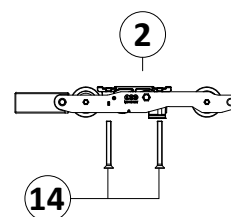
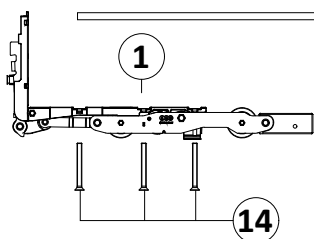
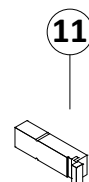
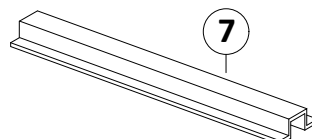
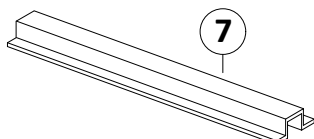
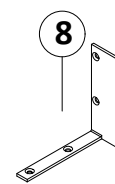
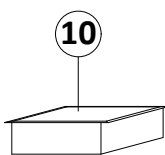
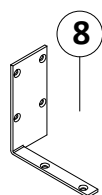
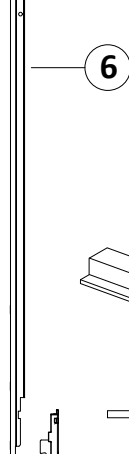

Schema | Type B

kg
250

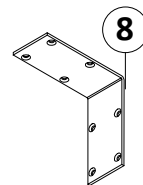
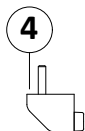
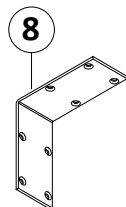
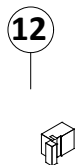
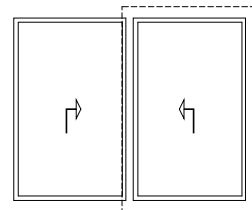

13*

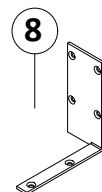
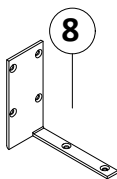

6

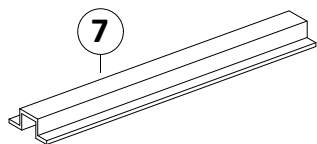
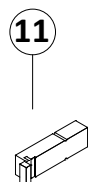
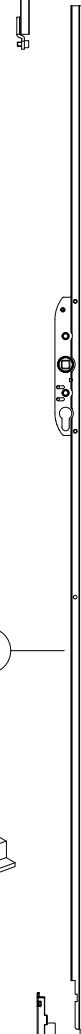

5

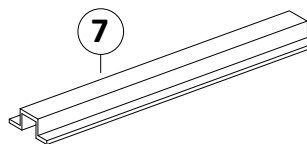

2

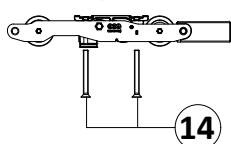

1

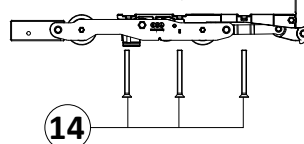

14

14

Schema | Type E

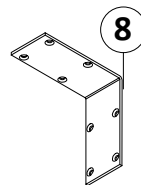
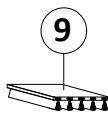
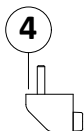
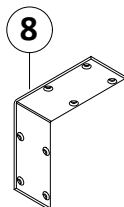
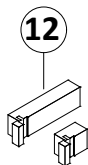
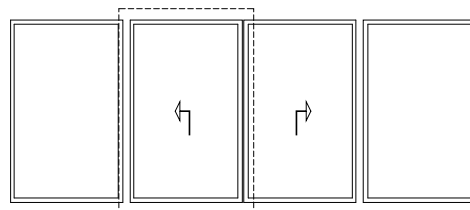

AG2986-7E - DESCRIZIONE DESCRIPTION AG2986-7E	
1	Carrello anteriore <i>Front carriage</i>
2	Carrello posteriore <i>Rear carriage</i>
3	Rostro di chiusura <i>Locking pin</i>
4	Fermo anta <i>Bumper stop</i>
5	Barra di unione <i>Stopper</i>
6	Meccanismo <i>Mechanism</i>
7	Profilo omega per fissaggio carrelli <i>Reinforcement profile for fixing carriage</i>
8	Kit rinforzo angoli <i>Kit reinforcement</i>
9	Tampone centrale di tenuta su guida sup. <i>Central sealing pad for upper rail</i>
10	Tampone centrale di tenuta su guida inf. <i>Central sealing pad for bottom rail</i>
11	Tampone di tenuta in neoprene <i>Neoprene sealing pads</i>
12	Tampone di tenuta in neoprene <i>Neoprene sealing pads</i>
13*	Prolunga meccanismo <i>Additional mechanism</i>
14	Vite fissaggio carrelli (CV1140I/M) <i>Carriage fixing screw (CV1140I/M)</i>

* Presente solo su kit AG2986E.E1
Only on the kit AG2986-E.E1

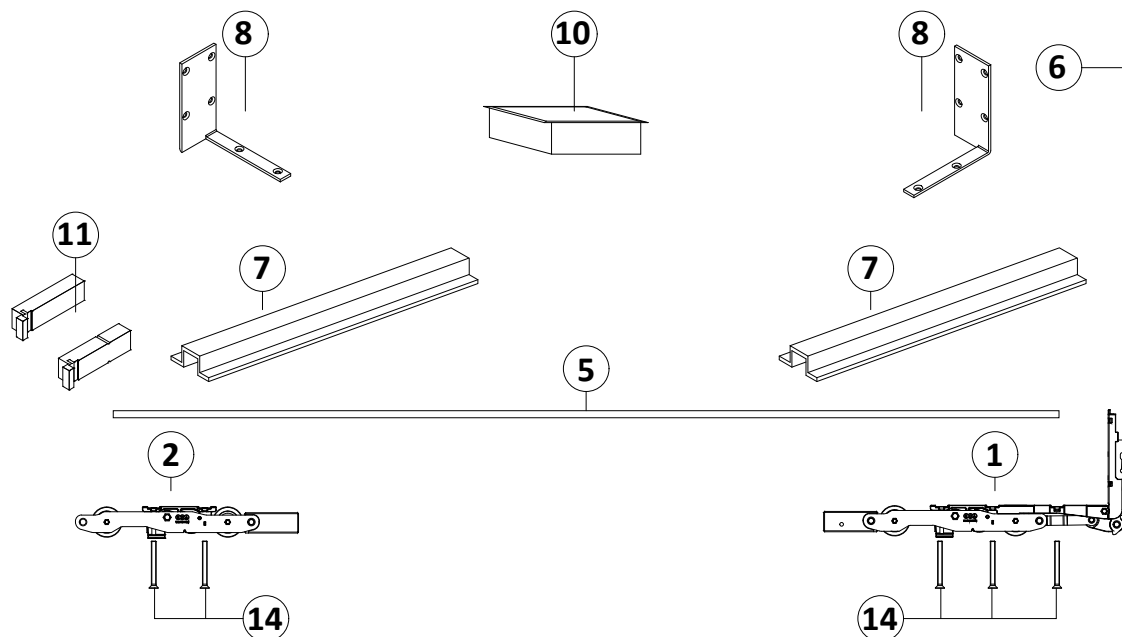
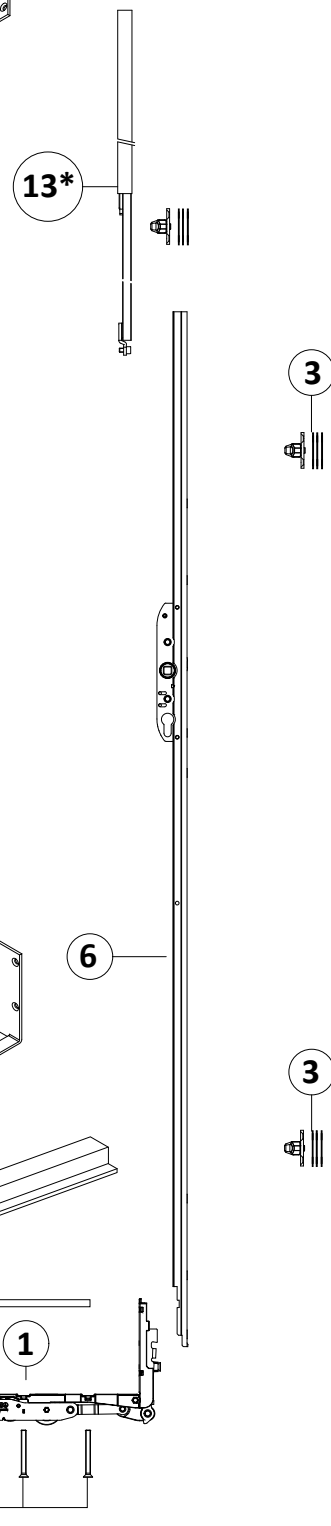

Schema | Type E

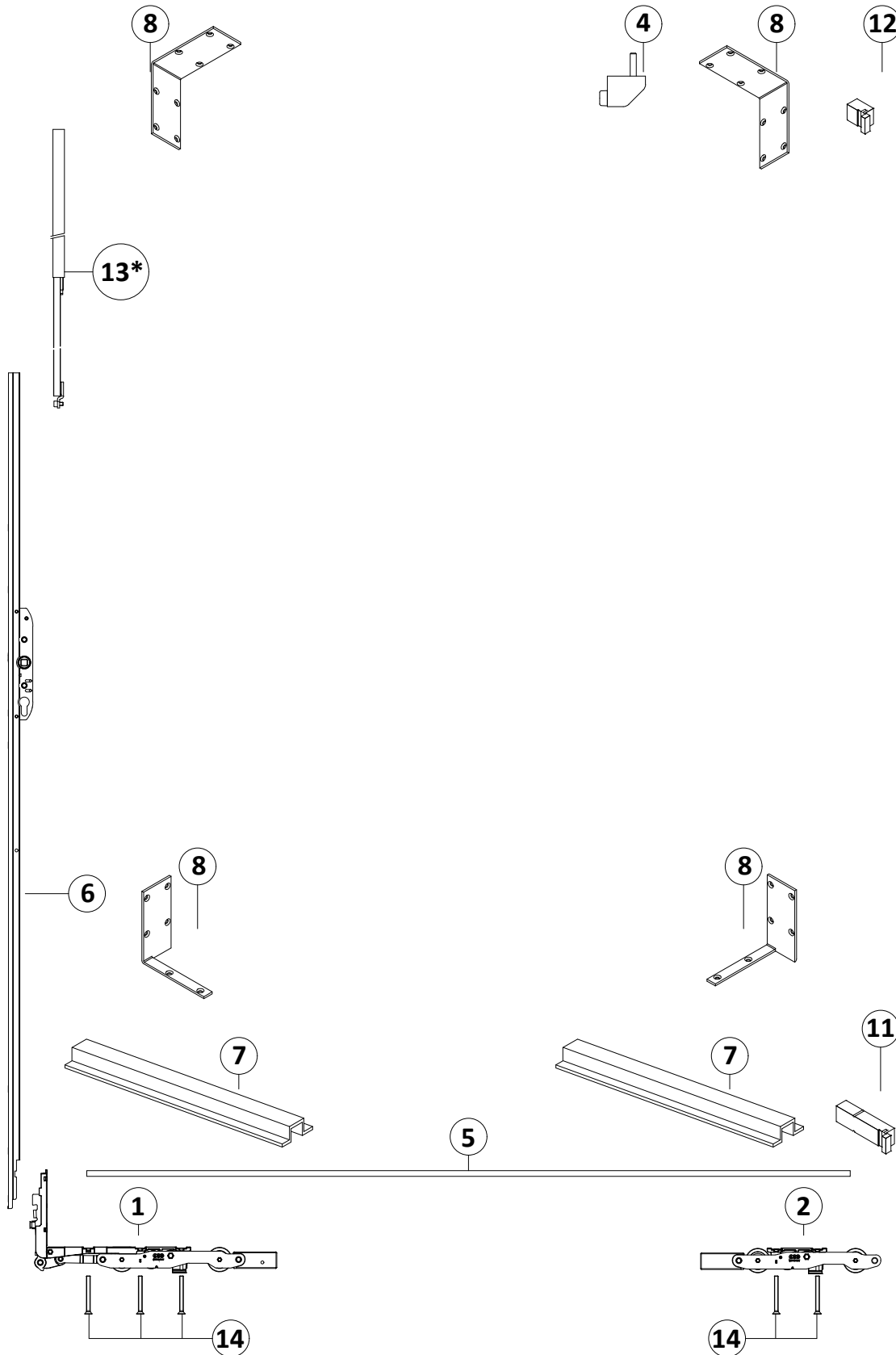
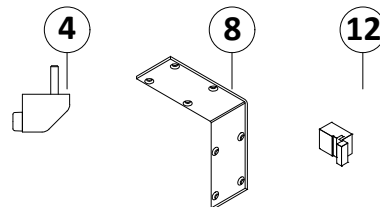
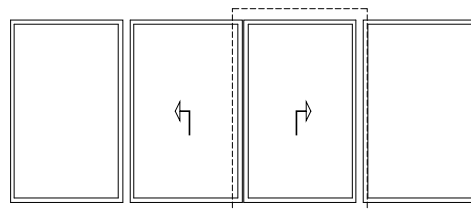

Schema | Type F

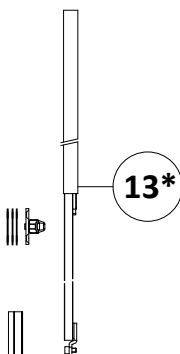
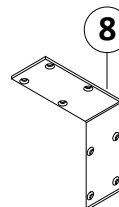
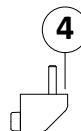
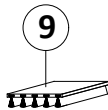
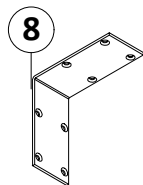
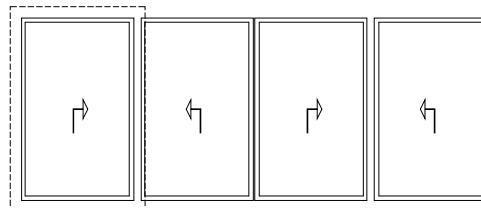

AG2986-7F - DESCRIZIONE DESCRIPTION AG2986-7F		
1	Carrello anteriore	Front carriage
2	Carrello posteriore	Rear carriage
3	Rostro di chiusura	Locking pin
4	Fermo anta	Bumper stop
5	Barra di unione	Stopper
6	Meccanismo	Mechanism
7	Profilo omega per fissaggio carrelli	Reinforcement profile for fixing carriage
8	Kit rinforzo angoli	Kit reinforcement
9	Tampone centrale di tenuta su guida sup.	Central sealing pad for upper rail
10	Tampone centrale di tenuta su guida inf.	Central sealing pad for bottom rail
11	Tampone di tenuta in neoprene	Neoprene sealing pads
12	Tampone di tenuta in neoprene	Neoprene sealing pads
13*	Prolunga meccanismo	Additional mechanism
14	Vite fissaggio carrelli (CV1140I/M)	Carriage fixing screw (CV1140I/M)

* Presente solo su kit AG2986F.E1
Only on the kit AG2986F.E1

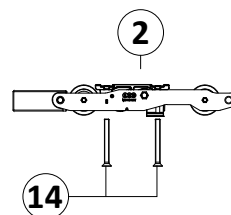
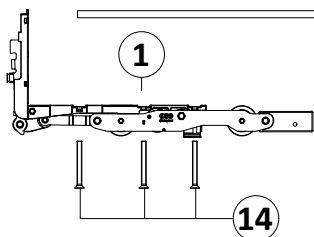
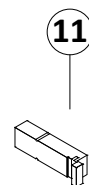
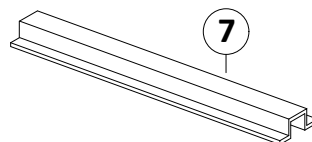
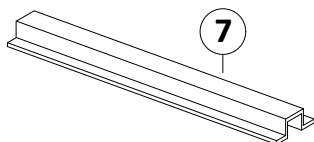
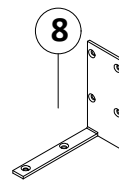
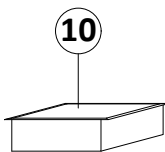
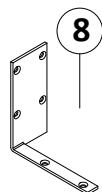
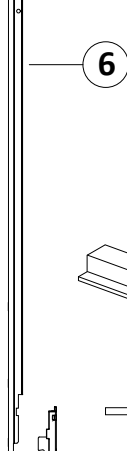

Schema | Type F

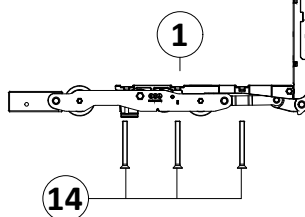
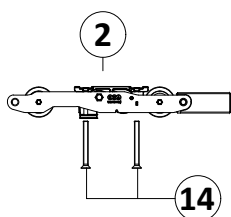
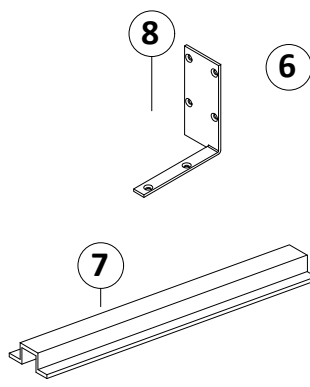
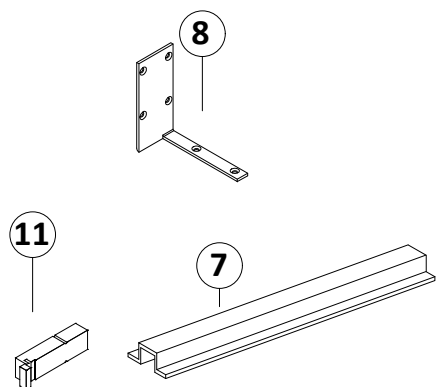
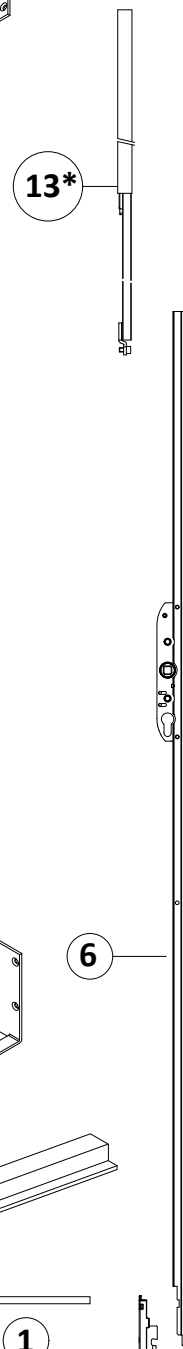
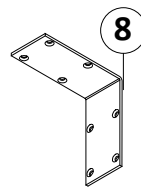
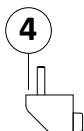
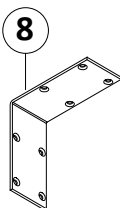
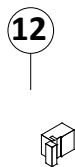
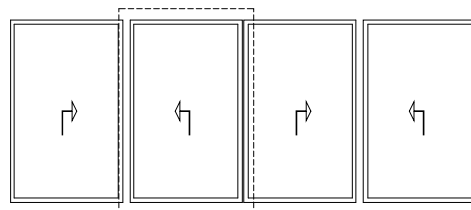

Schema | Type F

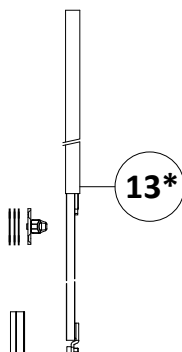
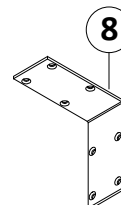
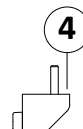
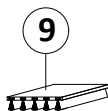
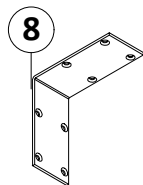
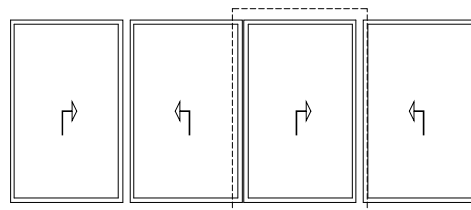

AG2986-7F - DESCRIZIONE DESCRIPTION AG2986-7F		
1	Carrello anteriore	Front carriage
2	Carrello posteriore	Rear carriage
3	Rostro di chiusura	Locking pin
4	Fermo anta	Bumper stop
5	Barra di unione	Stopper
6	Meccanismo	Mechanism
7	Profilo omega per fissaggio carrelli	Reinforcement profile for fixing carriage
8	Kit rinforzo angoli	Kit reinforcement
9	Tampone centrale di tenuta su guida sup.	Central sealing pad for upper rail
10	Tampone centrale di tenuta su guida inf.	Central sealing pad for bottom rail
11	Tampone di tenuta in neoprene	Neoprene sealing pads
12	Tampone di tenuta in neoprene	Neoprene sealing pads
13*	Prolunga meccanismo	Additional mechanism
14	Vite fissaggio carrelli (CV1140I/M)	Carriage fixing screw (CV1140I/M)

* Presente solo su kit AG2986F.E1
Only on the kit AG2986F.E1

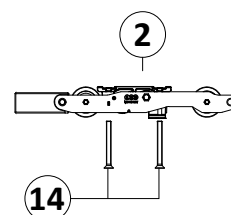
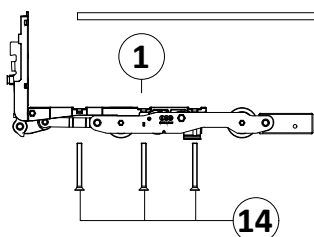
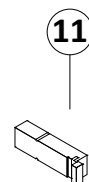
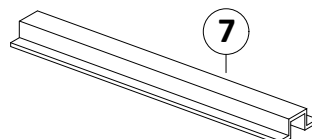
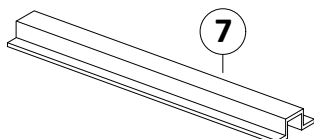
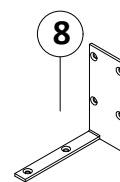
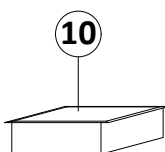
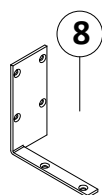
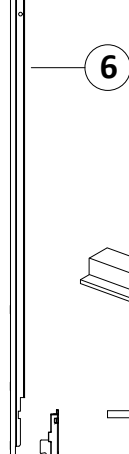

Schema | Type F

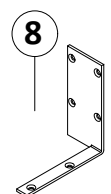
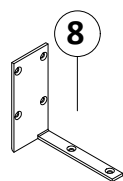
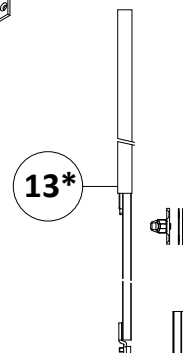
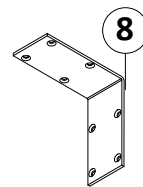
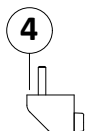
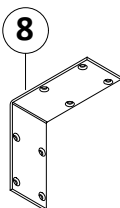
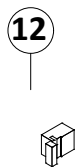
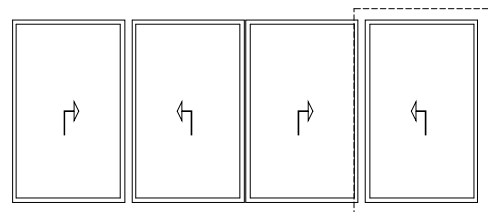

6

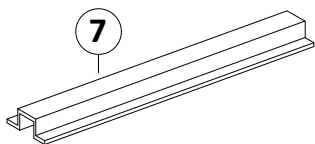
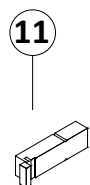

5

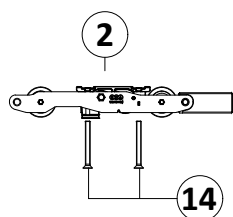
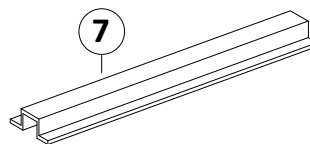

2

14

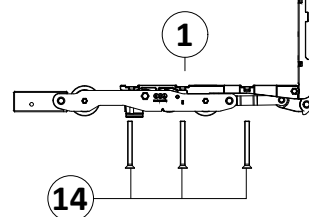

1

14

Schema | Type S1

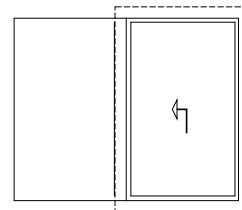

AG2986-7A - DESCRIZIONE DESCRIPTION AG2986-7A		
1	Carrello anteriore	Front carriage
2	Carrello posteriore	Rear carriage
3	Rostro di chiusura	Locking pin
4	Fermo anta	Bumper stop
5	Barra di unione	Stopper
6	Meccanismo	Mechanism
7	Profilo omega per fissaggio carrelli	Reinforcement profile for fixing carriage
8	Kit rinforzo angoli	Kit reinforcement
9	Tampone centrale di tenuta su guida superiore con spessore	Central sealing pad for upper rail with thickness
10	Tampone centrale di tenuta su guida inferiore con vaschetta	Central sealing pad for bottom rail whit pad case
11	Tampone di tenuta in neoprene	Neoprene sealing pads
12	Tampone di tenuta in neoprene	Neoprene sealing pads
13*	Prolunga meccanismo	Additional mechanism
14	Vite fissaggio carrelli (CV1140I/M)	Carriage fixing screw (CV1140I/M)

* Presente solo su kit AG2986-7S1.E1
Only on the kit AG2986-7S1.E1

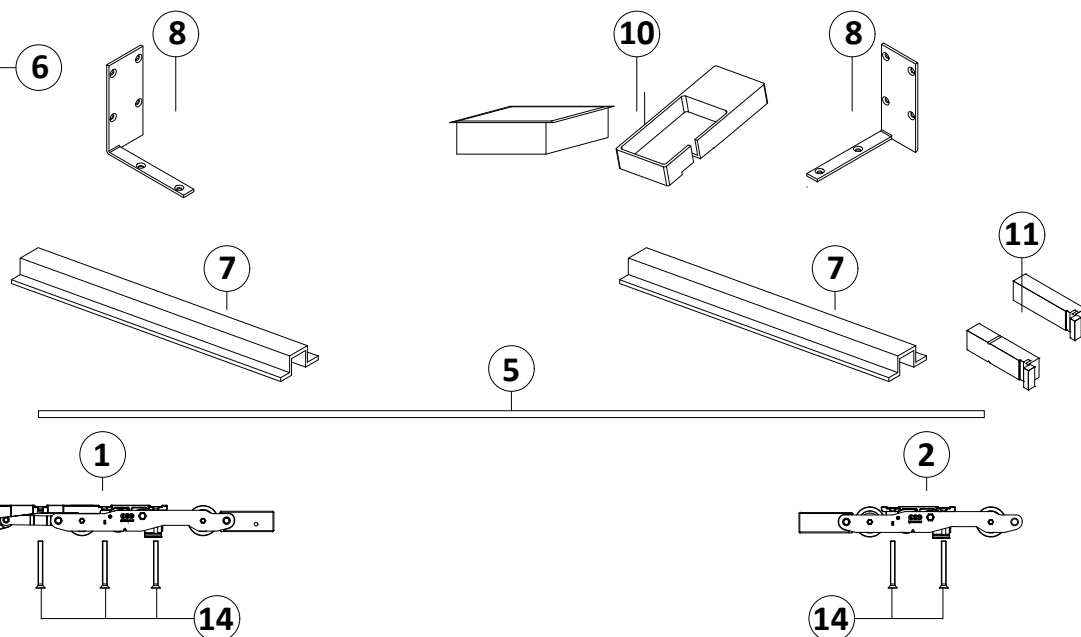
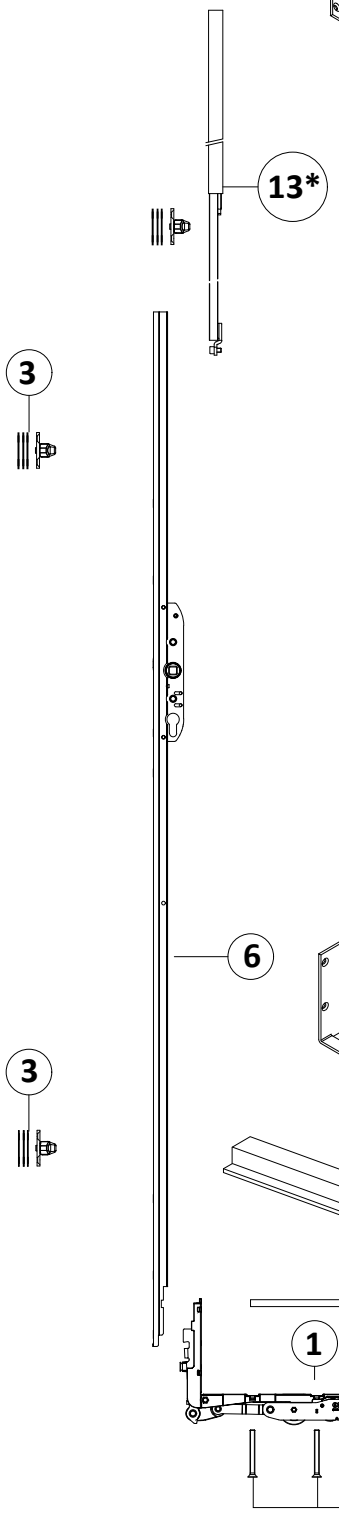

Schema | Type T1

kg
250

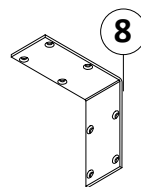
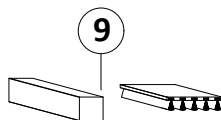
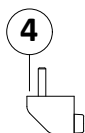
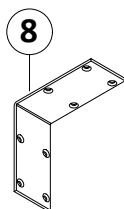
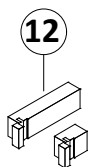
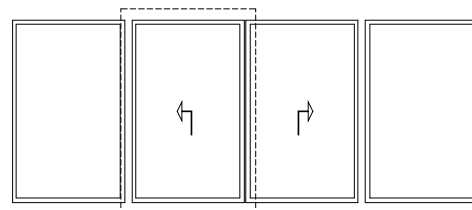

AG2986-7E - DESCRIZIONE DESCRIPTION AG2986-7E		
1	Carrello anteriore	Front carriage
2	Carrello posteriore	Rear carriage
3	Rostro di chiusura	Locking pin
4	Fermo anta	Bumper stop
5	Barra di unione	Stopper
6	Meccanismo	Mechanism
7	Profilo omega per fissaggio carrelli	Reinforcement profile for fixing carriage
8	Kit rinforzo angoli	Kit reinforcement
9	Tampone centrale di tenuta su guida superiore con spessore	Central sealing pad for upper rail with thickness
10	Tampone centrale di tenuta su guida inferiore con vaschetta	Central sealing pad for bottom rail with pad case
11	Tampone di tenuta in neoprene	Neoprene sealing pads
12	Tampone di tenuta in neoprene	Neoprene sealing pads
13*	Prolunga meccanismo	Additional mechanism
14	Vite fissaggio carrelli (CV1140I/M)	Carriage fixing screw (CV1140I/M)

* Presente solo su kit AG2986T1.E1
Only on the kit AG2986T1.E1

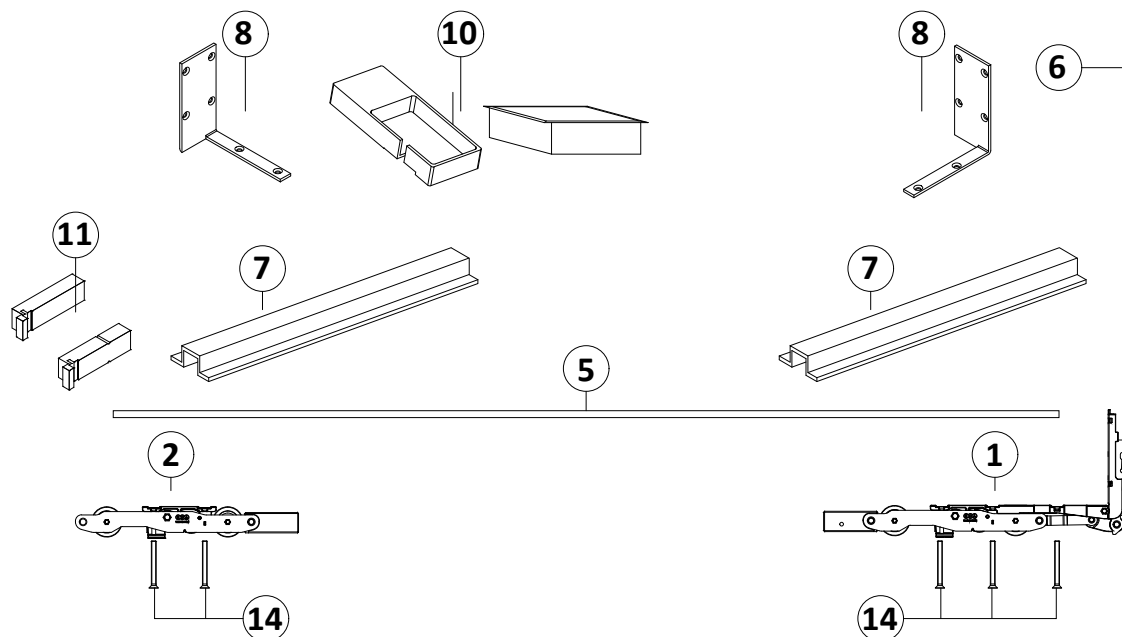
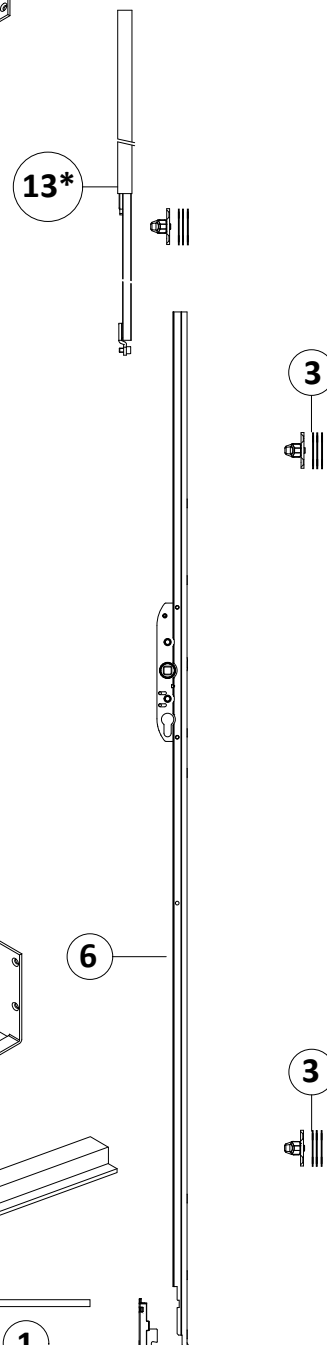

Schema | Type T1

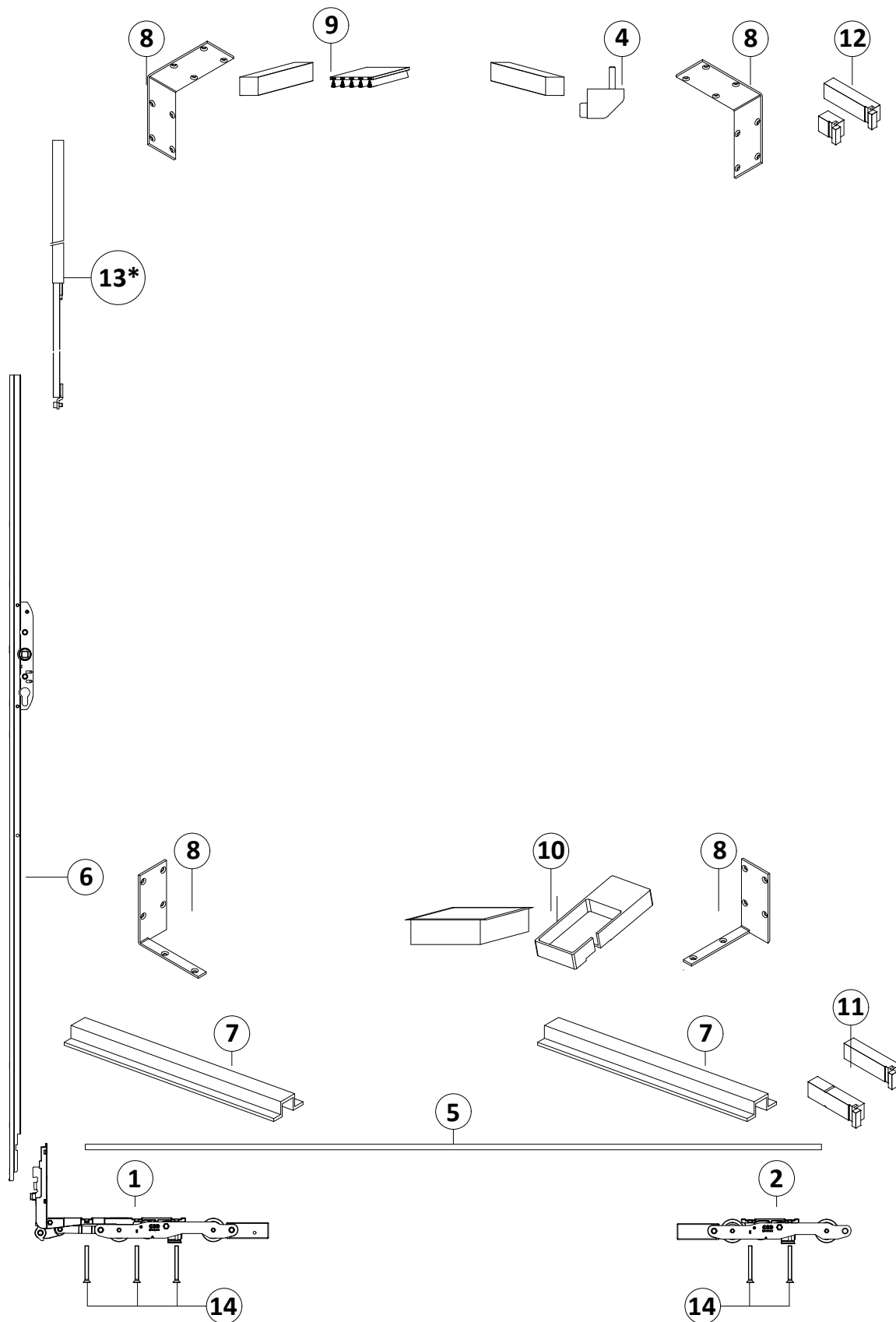
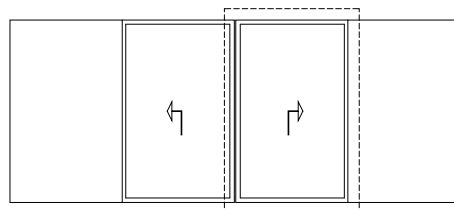

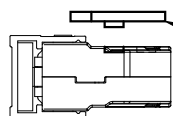
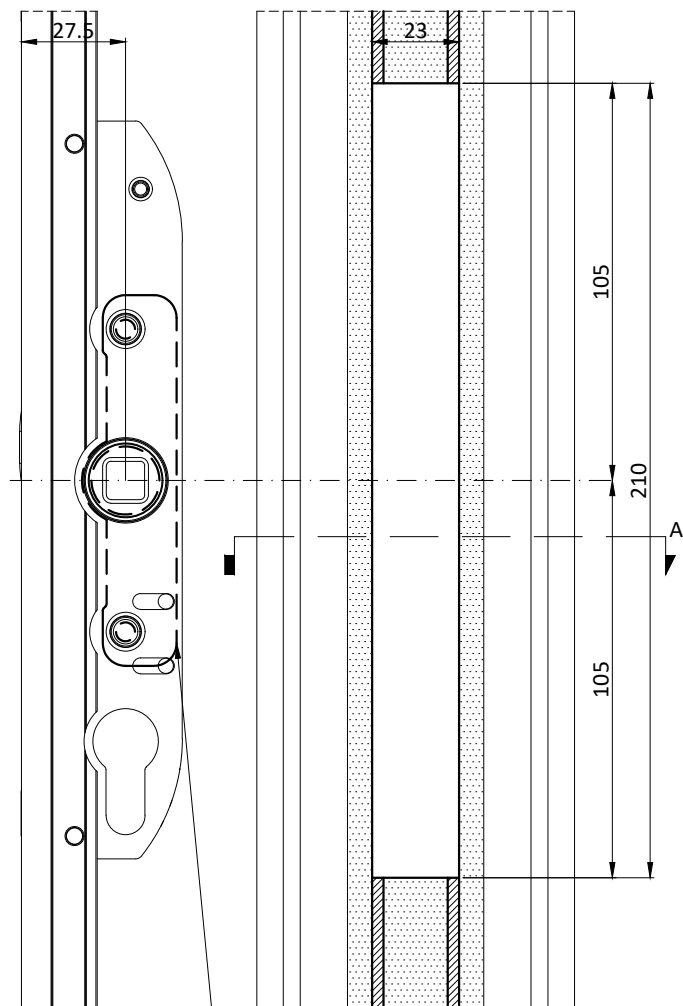
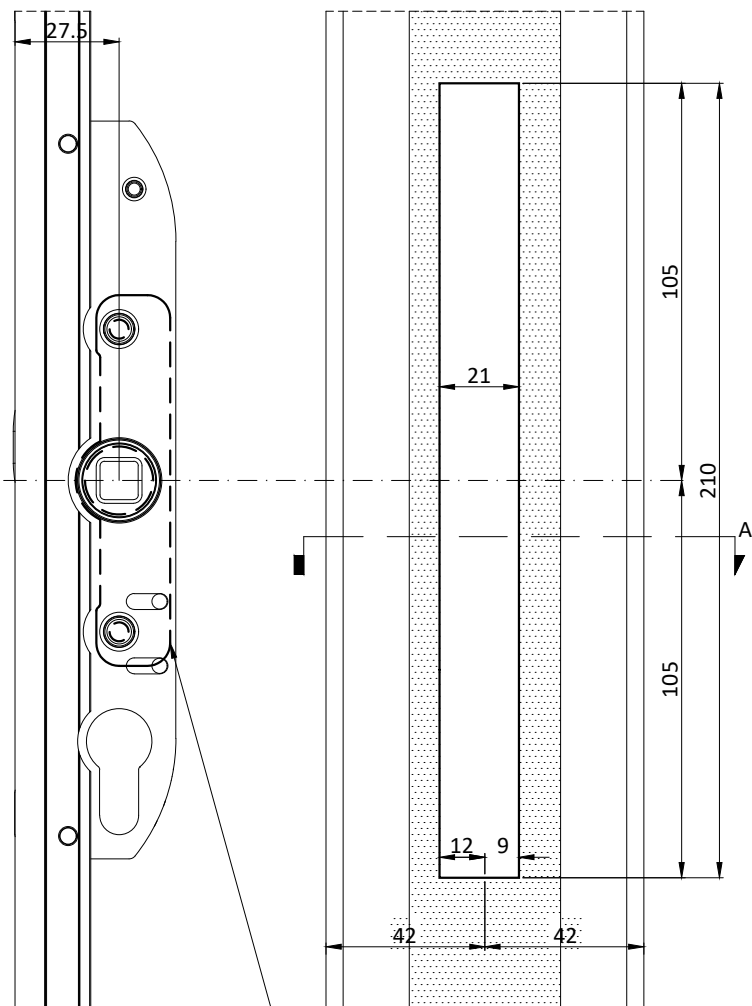
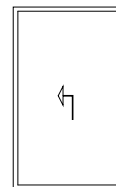

piatto fissaggio maniglione singolo
con fori M5 applicare a pressione
*single handle fixing plate
with M5 holes press-fit*

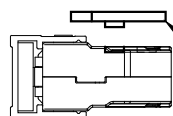

piatto fissaggio maniglione singolo
con fori M5 applicare a pressione
*single handle fixing plate
with M5 holes press-fit*

sezione | section A

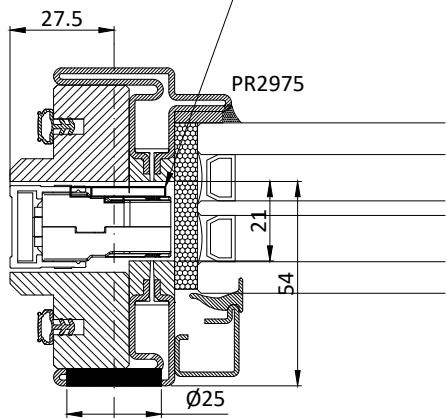

sezione | section A'

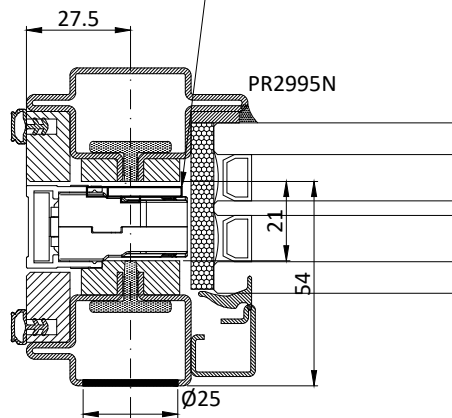

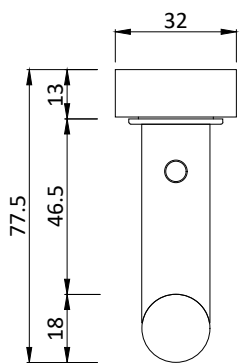

ACV078 finiture
ACV078 finishing

SB acciaio inox | stainless steel
CZ acciaio corten | corten steel
BR ottone grezzo | untreated brass

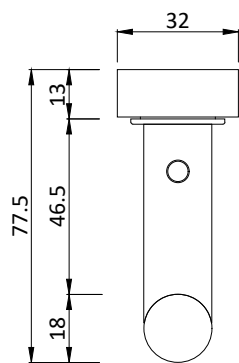

ACV078Y - ACV178Y finiture
ACV078Y - ACV178Y finishing

SB acciaio inox | stainless steel
CZ acciaio corten | corten steel
BR ottone grezzo | untreated brass

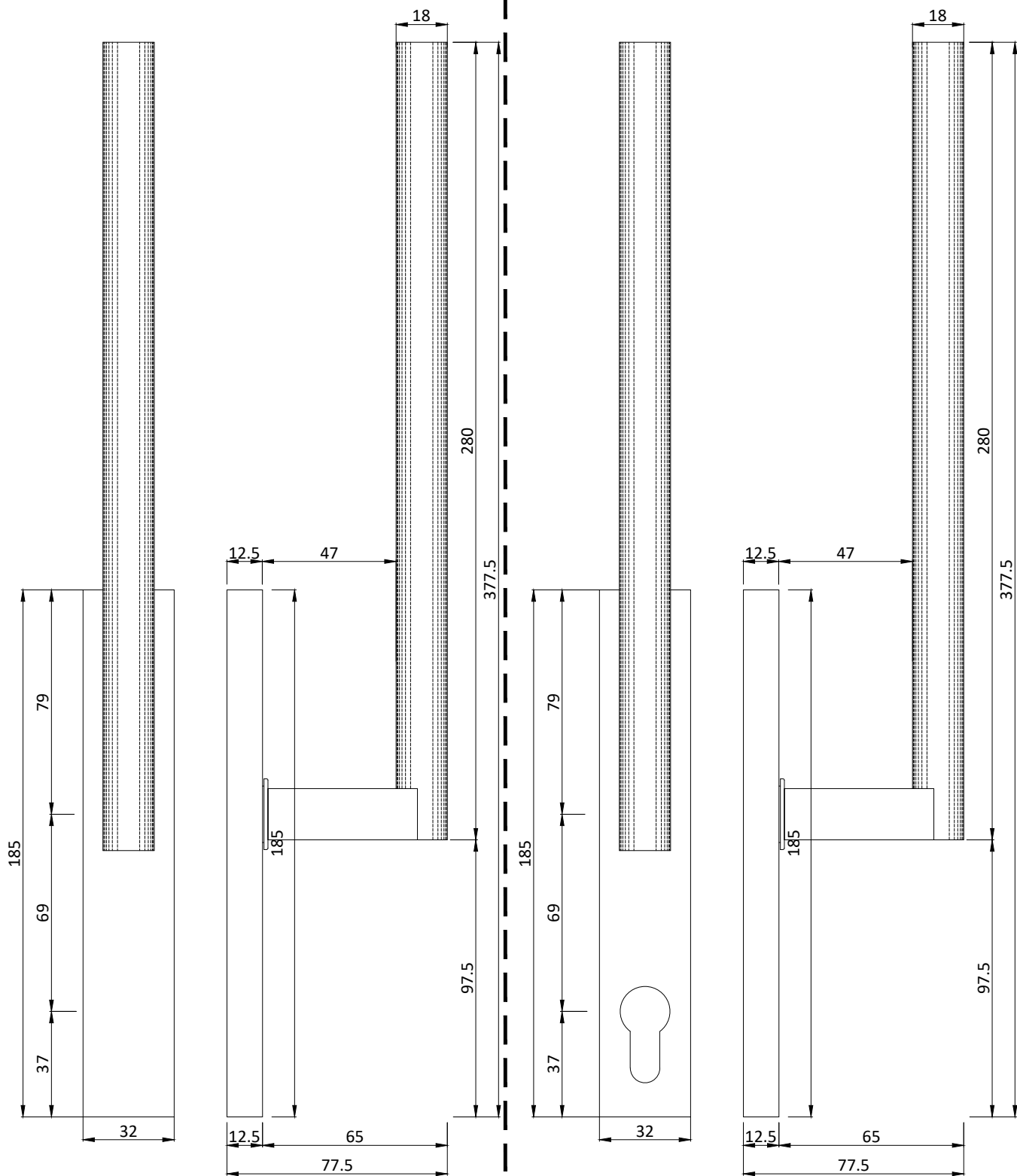

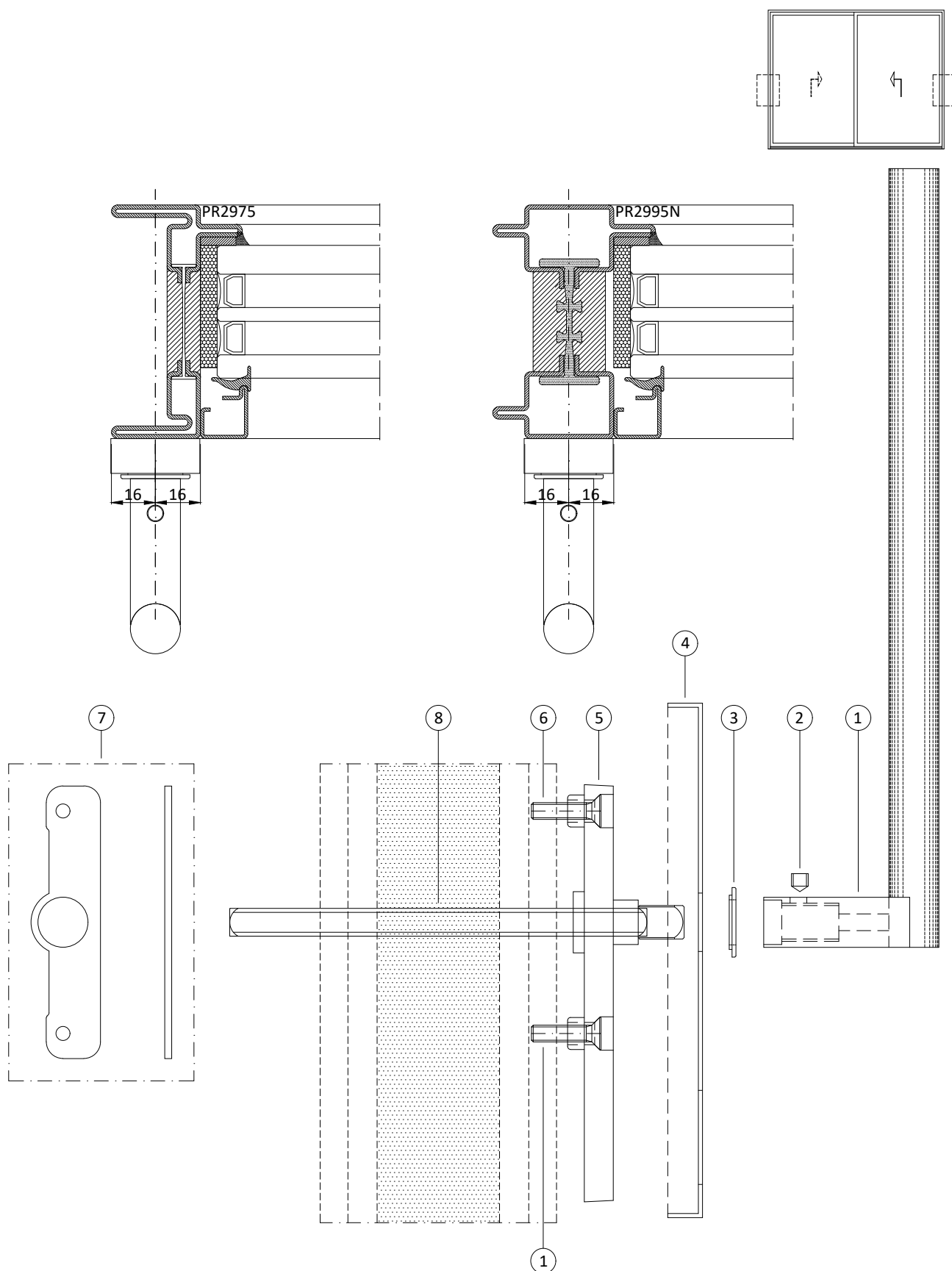

ACV078/Y componenti | components

1. impugnatura | handle
2. grano M6 | dowel M6
3. rondela | ring
4. rosetta | escutcheon

5. corpo maniglione | handle
6. vite TPSC M5x60 | TPSC M5x60 screws
7. piastra fissaggio maniglione singolo
plate to attach single handle
8. quadro 10x150 | square 10x150

ACV078/Y finiture | finishing

- SB acciaio inox | stainless steel
- CZ acciaio corten | corten steel
- BR ottone grezzo | untreated brass

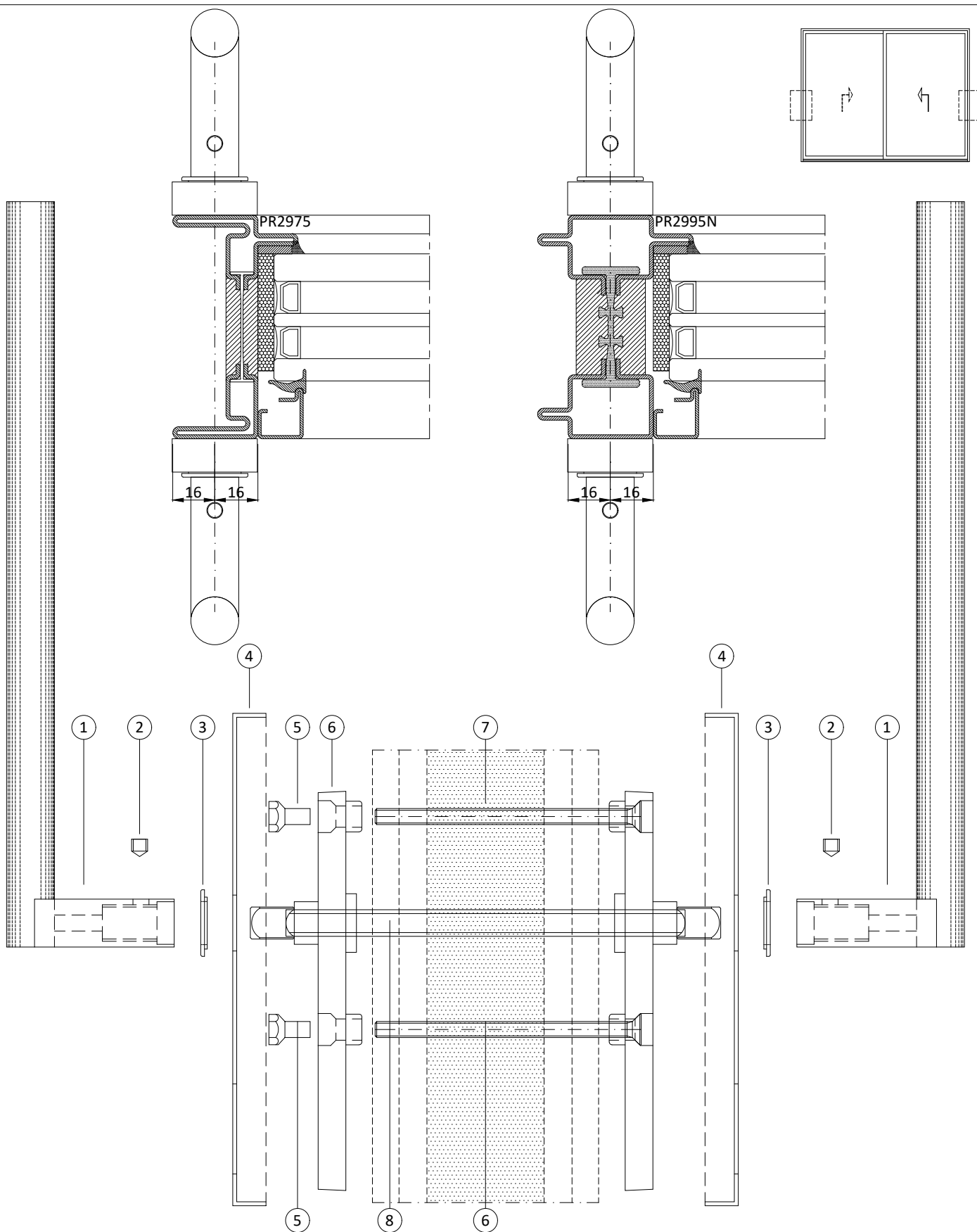

ACV178/Y componenti | components

- | | |
|-------------------------|--|
| 1. impugnatura handle | 5. inserto filettato M6 M6 thread |
| 2. grano M6 dowel M6 | 6. corpo maniglione handle |
| 3. rondela ring | 7. vite TPSC M6x100 TPSC M6x100 screws |
| 4. rosetta escutcheon | 8. quadro 10x150 square 10x150 |

ACV178/Y finiture | finishing

- SB acciaio inox | stainless steel
- CZ acciaio corten | corten steel
- BR ottone grezzo | untreated brass

1 ANTA SCORREVOLE ED 1 ANTA FISSA
1 SLIDING AND 1 FIXED SASH

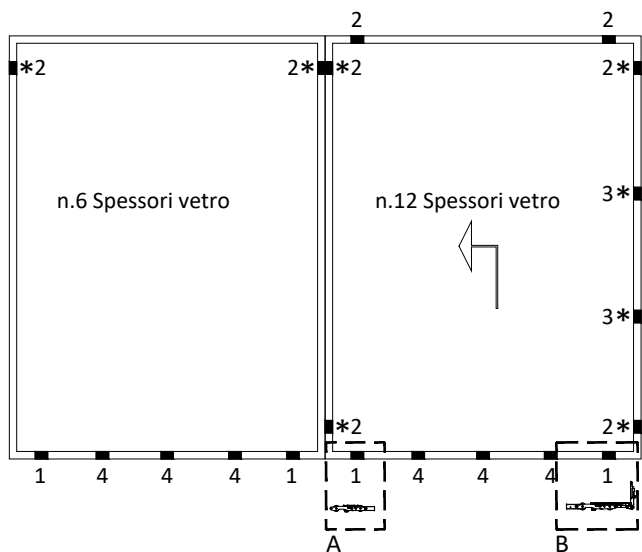

2 ANTE SCORREVOLI
2 SLIDING SASHES

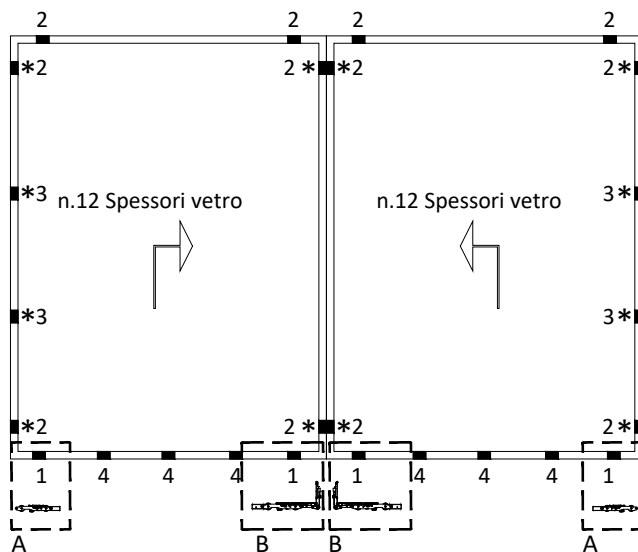

PARTICOLARE "A"
PARTICULAR "A"

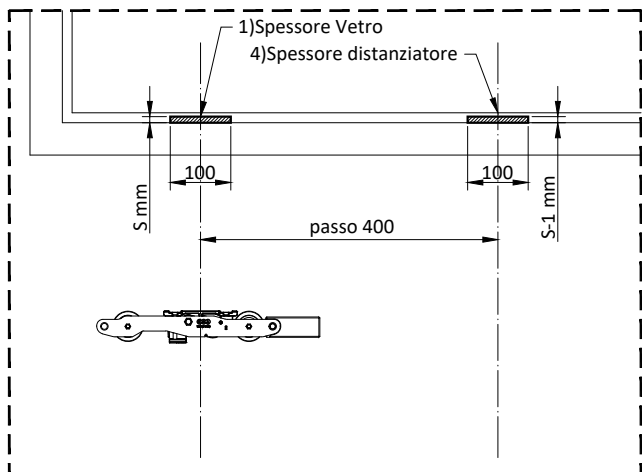

PARTICOLARE "B"
PARTICULAR "B"

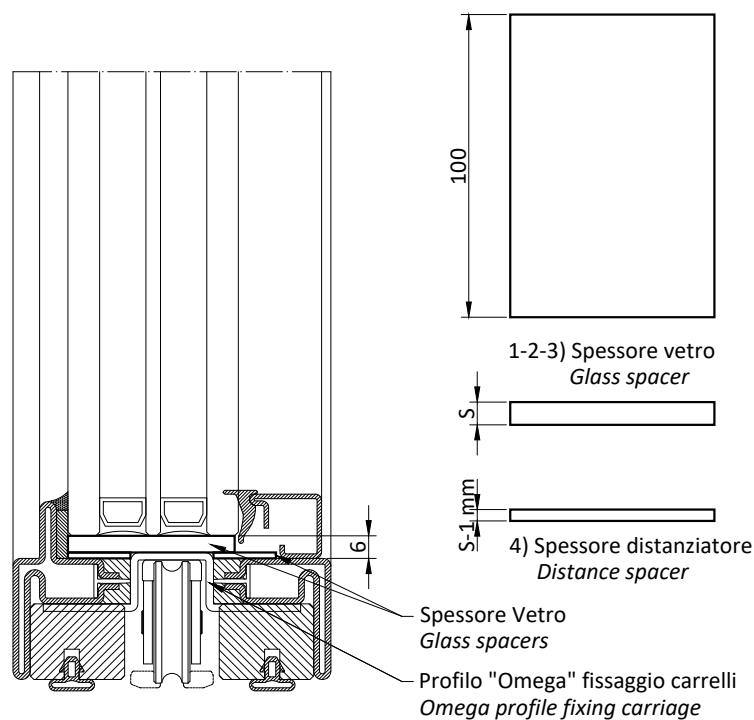
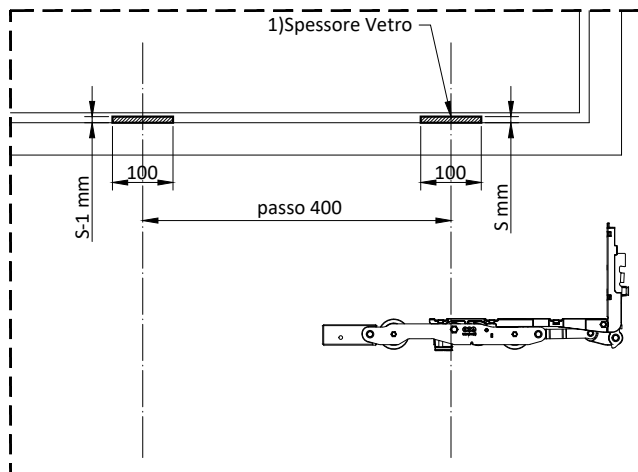

- 1) Spessore portante (allineato ai carrelli dove presenti)
- 2) Spessore distanziatore
- 3) Spessore distanziatore per punti di chiusura
- 4) Spessore distanziatore

- 1) Load-bearing spacer (aligned with carriages if present)
- 2) Distance spacer
- 3) Distance spacer for locking points
- 4) Distance spacer

* Verticalmente fissare spessore vetro con Silicone

* Attach glass spacer vertically with Seal

CAPITOLO MOTORIZZAZIONE OS2 75 AS 2.0

AUTOMATISATION CHAPTER OS2 75 AS 2.0



Non manomettere, smontare o utilizzare in modo improprio il motore pena invalidità della garanzia
Don't tamper, don't disassemble, don't use improperly the motor otherwise the warranty will be invalid

 Non manomettere, smontare o utilizzare in modo improprio il motore pena invalidità della garanzia
Don't tamper, don't disassemble, don't use improperly the motor otherwise the warranty will be invalid

Schema | Type S1

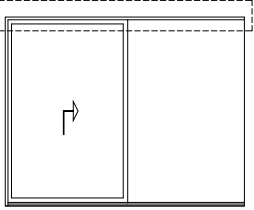

Schema | Type A
Schema | Type B*

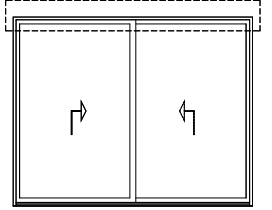

Schema | Type A

Schema | Type B*

*
Anta interna motorizzata
Anta esterna manuale
Motorized internal door
Manual external door

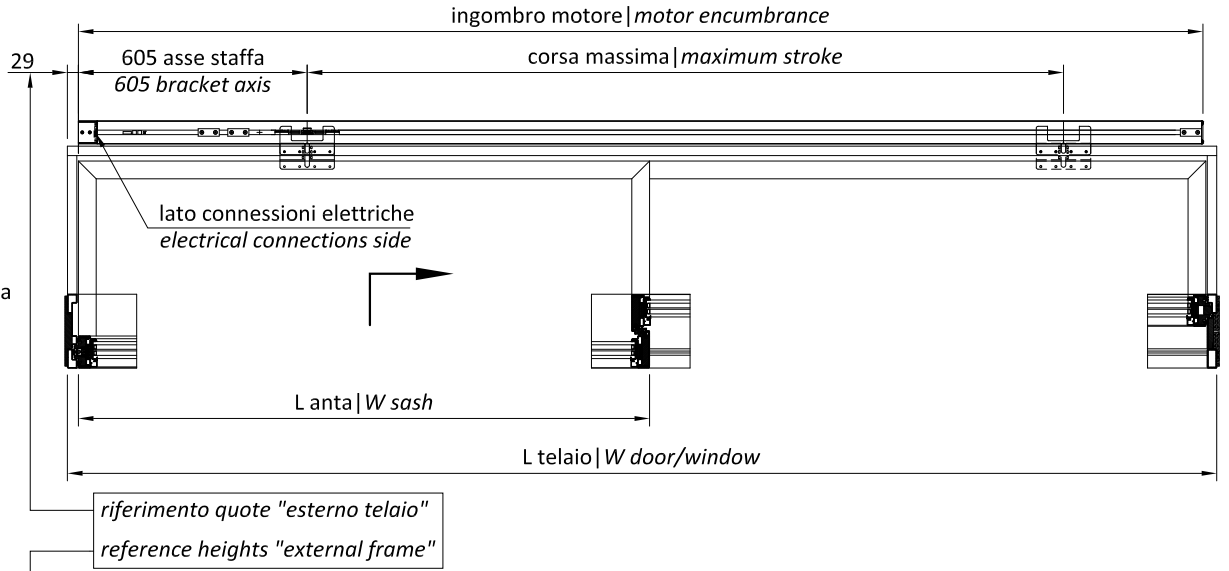

Schema | Type S1

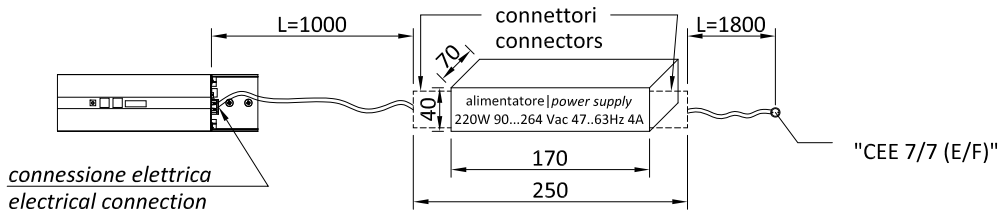
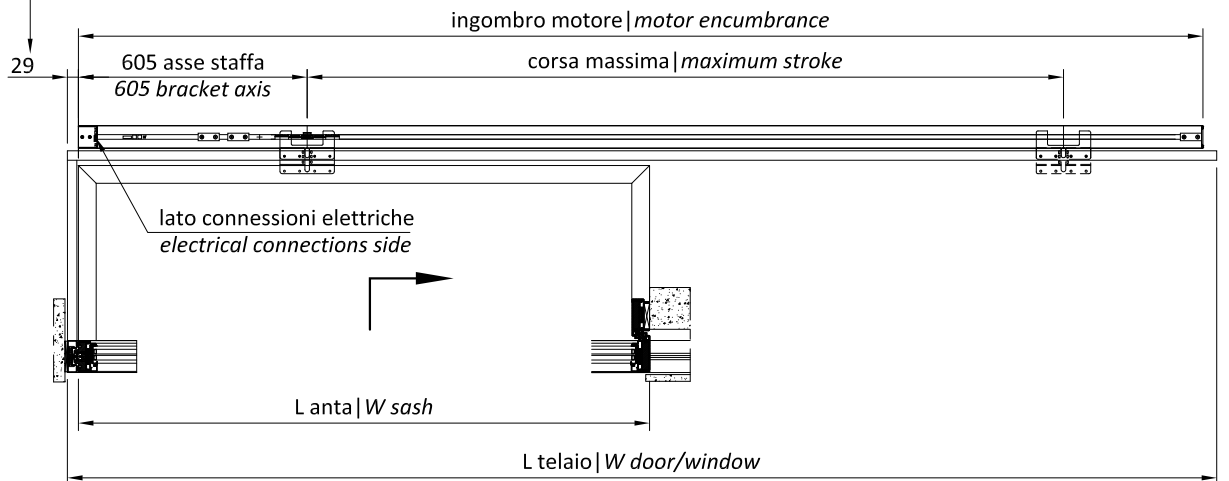

motorizzazioni alzante scorrevole/lift-and-slide automatisaton				
larghezza anta sash width		ingombro motore motor encumbrance	corsa max maximum stroke	codice code peso anta max max weight sash <250 kg
L min	L max			
1135	1430	2174	1400	MBS140
1431	1995	2774	2000	MBS200

Schema | Type E
Schema | Type F*

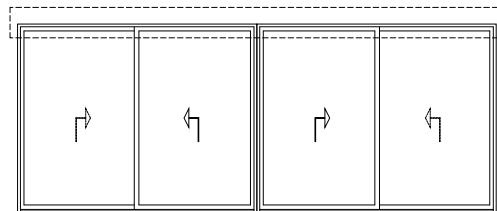

Schema | Type T1

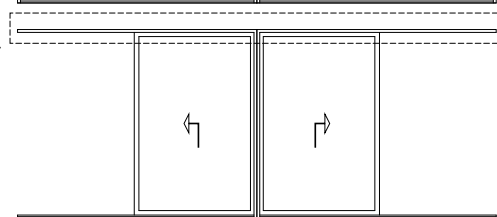

Non manomettere, smontare o utilizzare in modo improprio il motore pena invalidità della garanzia
Don't tamper, don't disassemble, don't use improperly the motor otherwise the warranty will be invalid

Schema | Type E

Schema | Type F*

*
Ante interne motorizzate
Ante esterne manuali
Motorized internal doors
Manual external doors

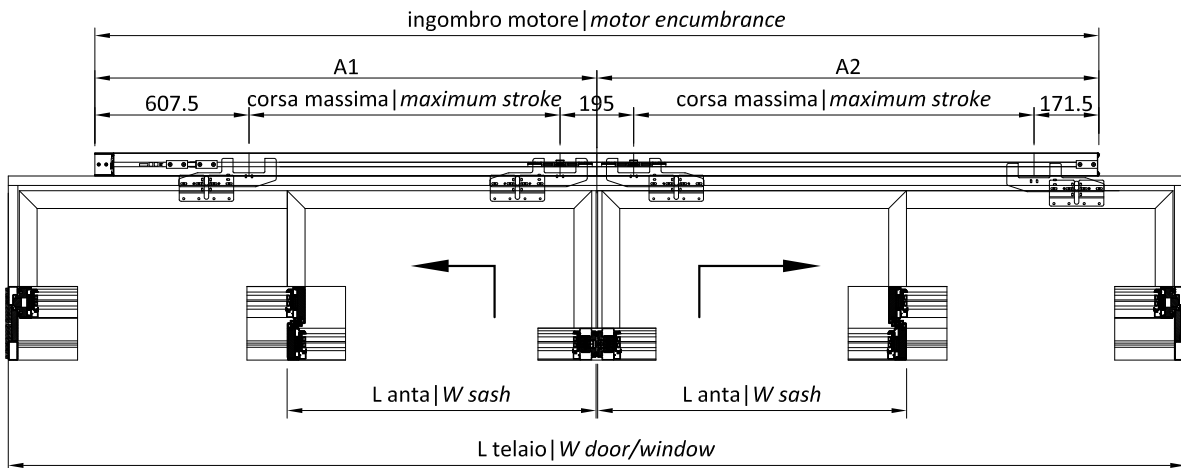

Schema | Type T1

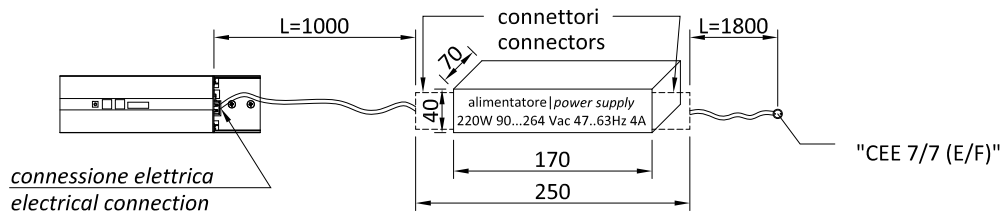
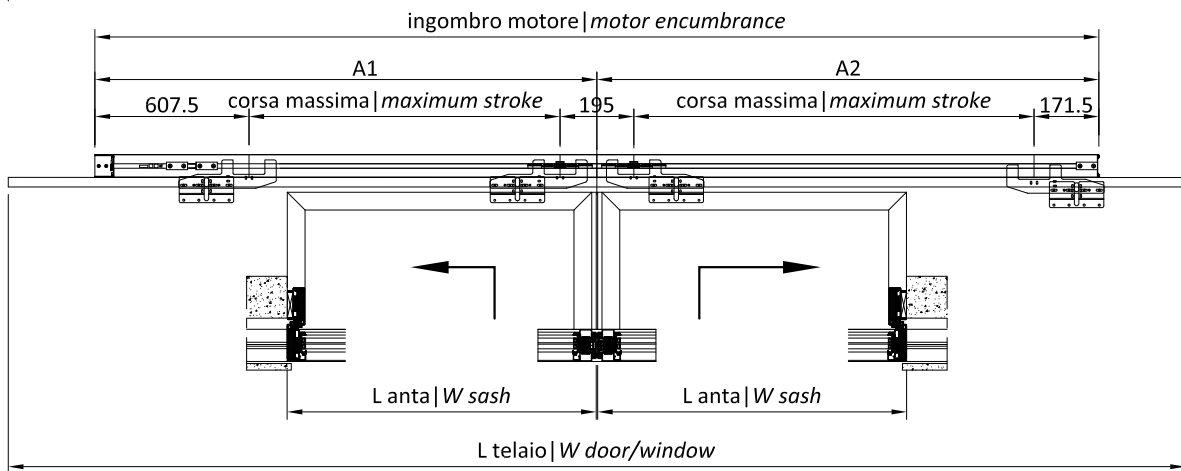

motorizzazioni alzante scorrevole/lift-and-slide automatisation						
larghezza anta sash width		ingombro motore Motor encumbrance	corsa max maximum stroke	posizionamento motore motor position		codice code peso anta max max weight sash <250 kg
L min	L max			A1	A2	
1135	1500	3974	1500+1500	2105	1869	MBX150
1501	1995	4974	2000+2000	2605	2369	MBX200



Schema | Type E
Schema | Type F

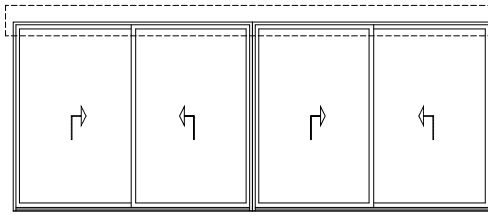

Schema | Type A
Schema | Type B

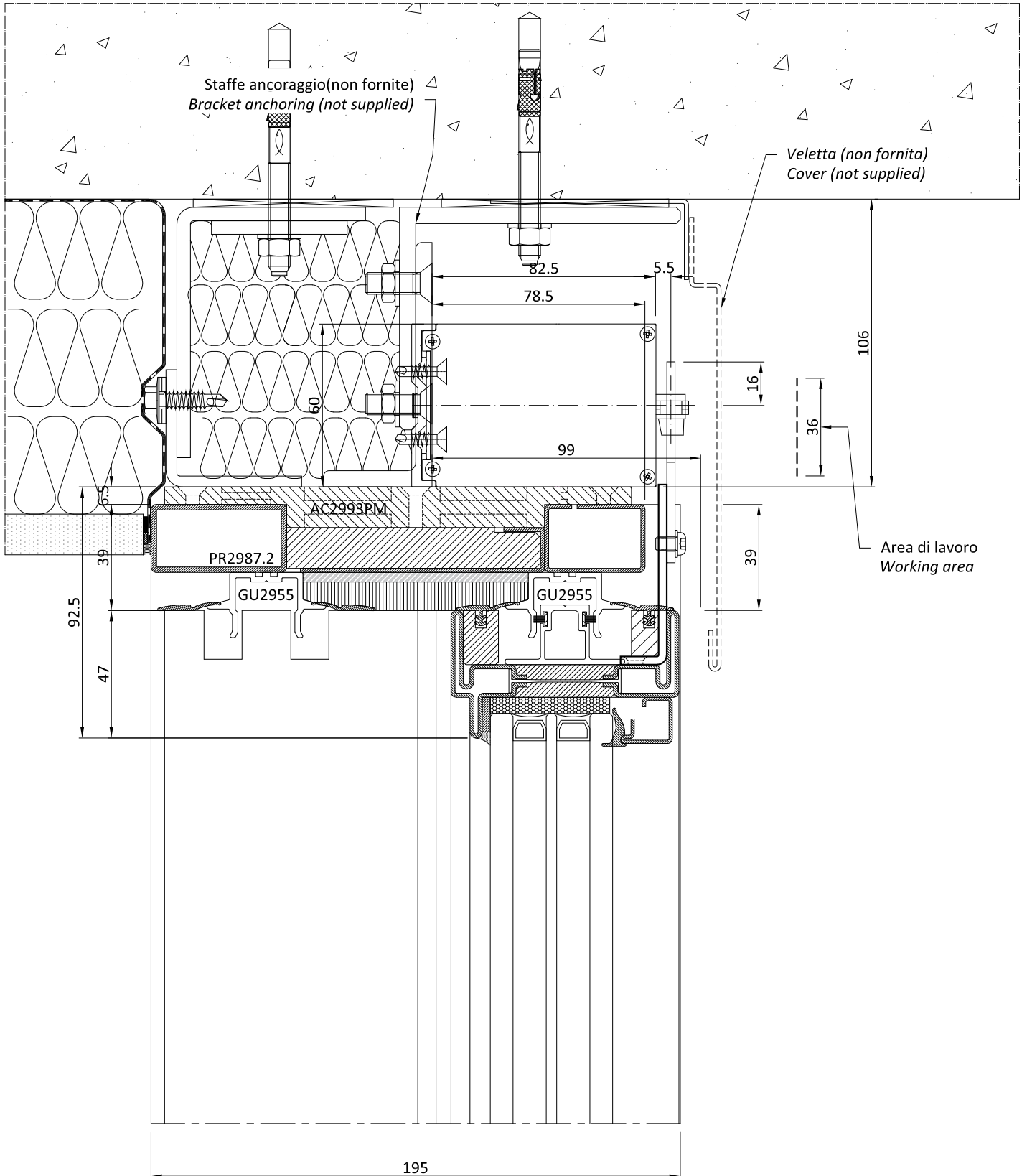
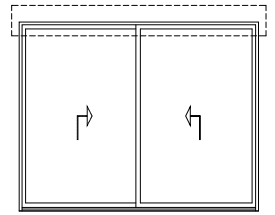

Schema | Type T1

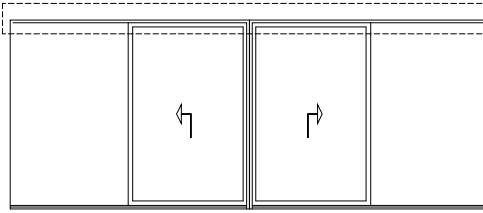

Schema | Type S1

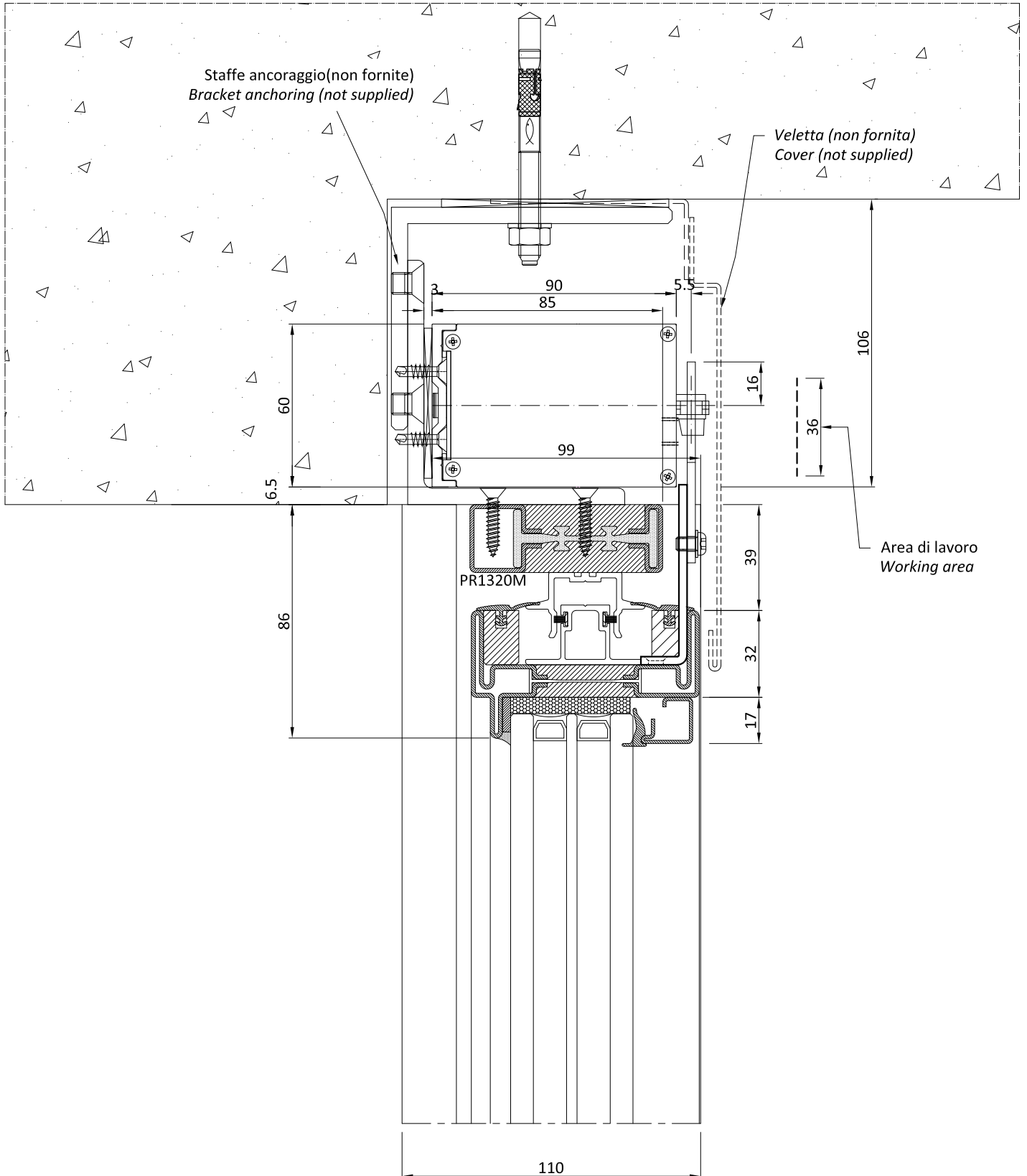
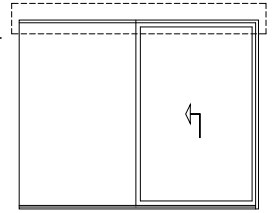

 Non manomettere, smontare o utilizzare in modo improprio il motore pena invalidità della garanzia
Don't tamper, don't disassemble, don't use improperly the motor otherwise the warranty will be invalid

Schema | Type S1

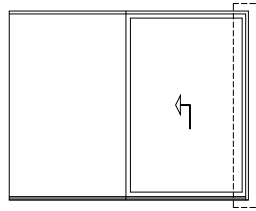

Schema | Type A
Schema | Type B

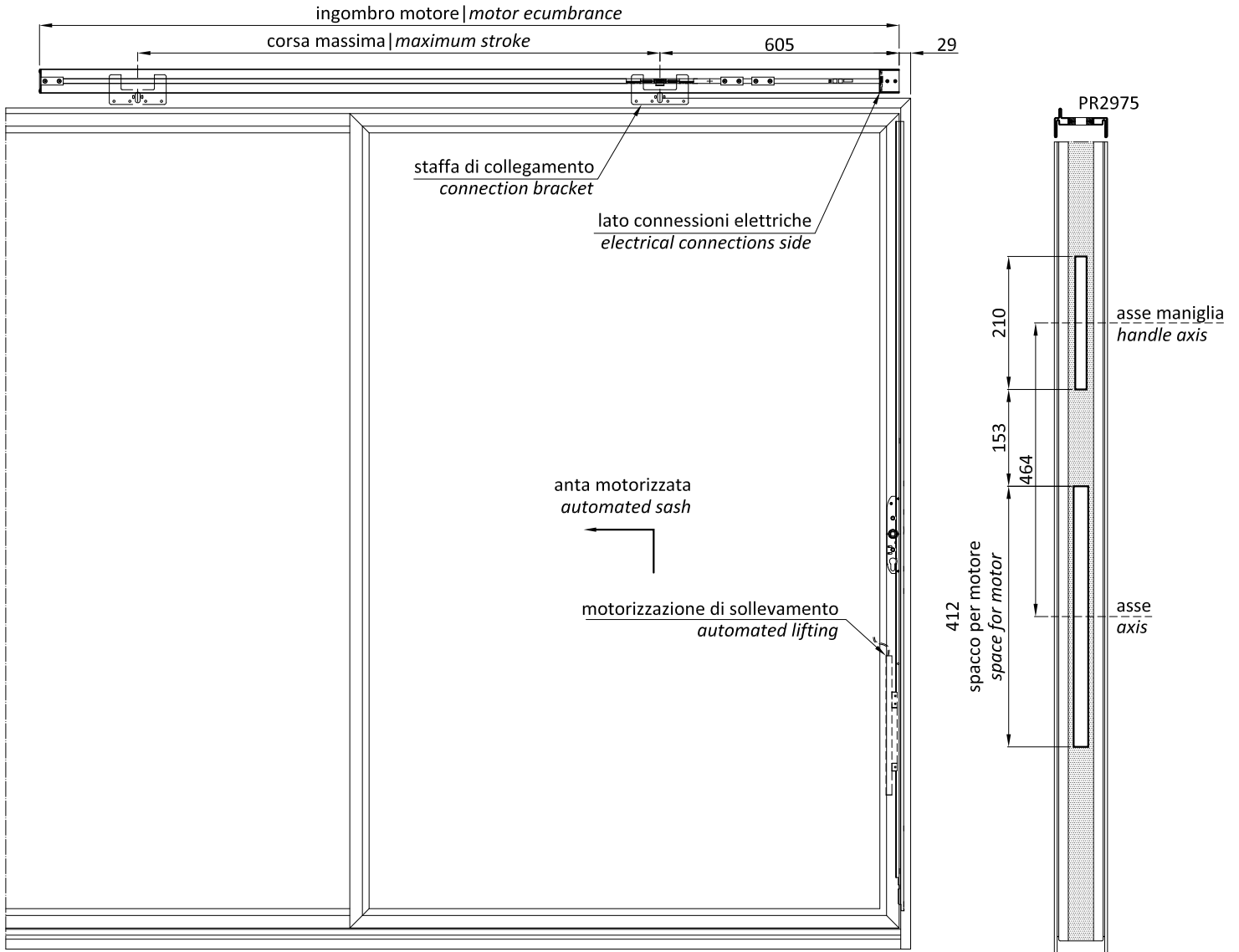
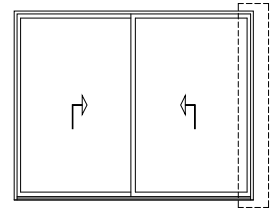

foro per sollevamento manuale
hole for manual lifting

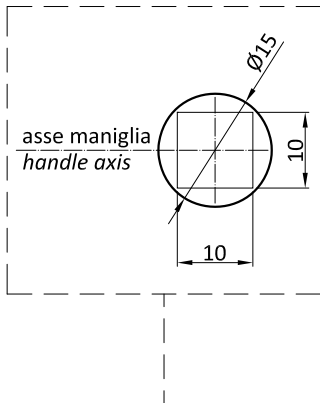

cremonese
cremone

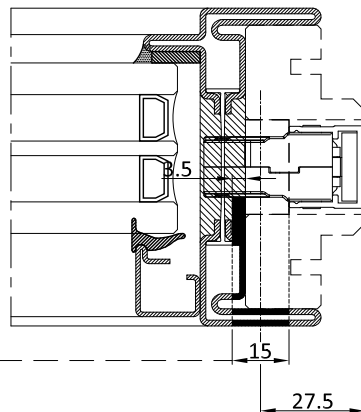

motore sollevamento
automated lifting

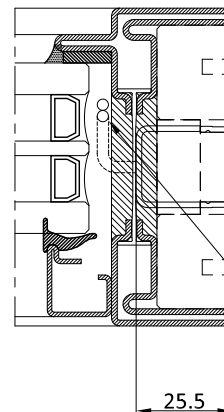

ATTENZIONE segnalato con apposito adesivo il foro di fissaggio da non utilizzare in quanto interferisce con il motore di sollevamento

ATTENTION the fixing hole must not be used as it interferes with the lifting motor and must be marked with a sticker

cavi di alimentazione
power source wiring

Schema | Type E
Schema | Type F



Non manomettere, smontare o utilizzare in modo improprio il motore pena invalidità della garanzia
Don't tamper, don't disassemble, don't use improperly the motor otherwise the warranty will be invalid

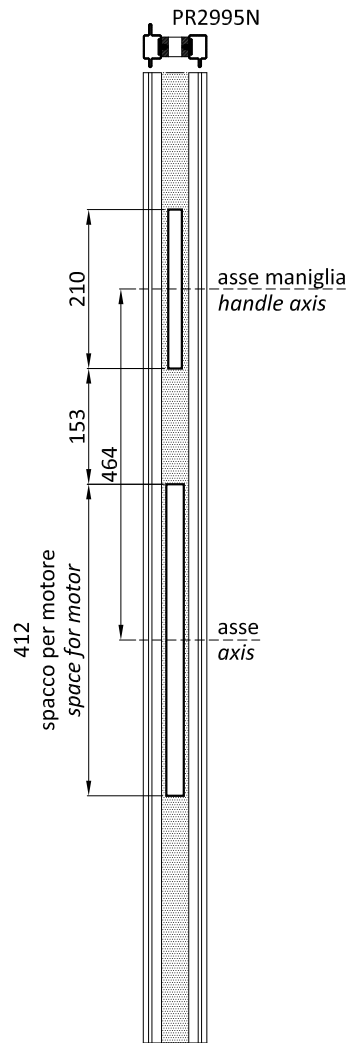
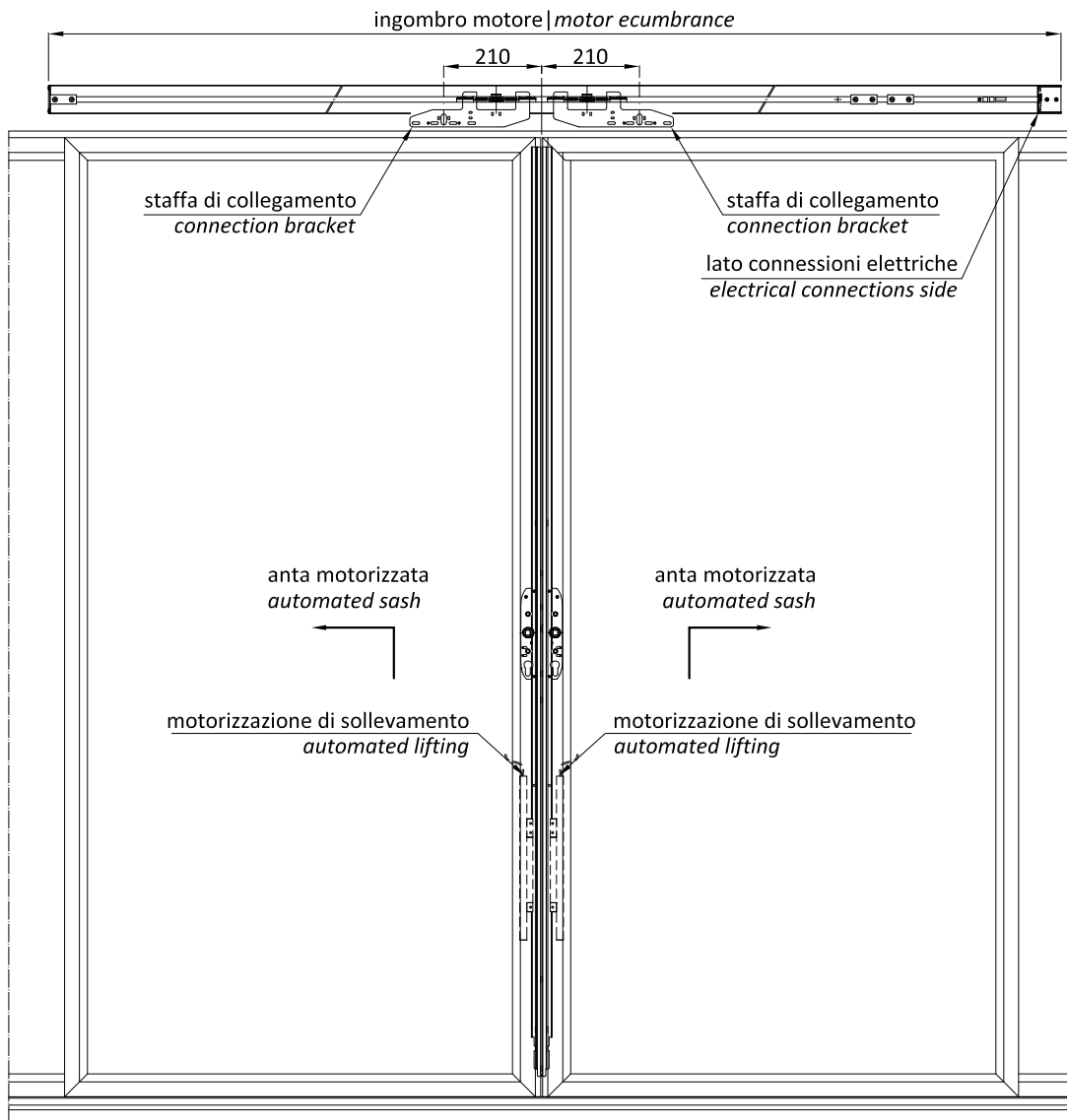
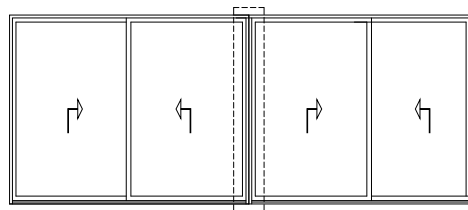

foro per sollevamento manuale
hole for manual lifting

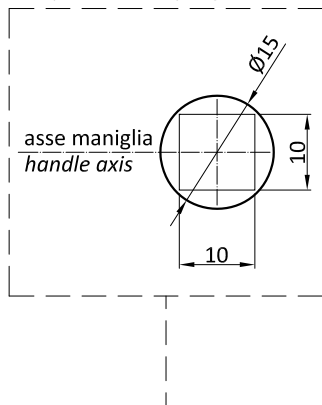

cremonese
cremone

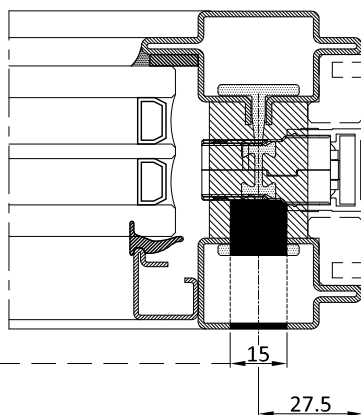

motore sollevamento
automated lifting

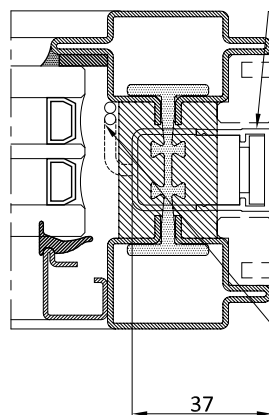

ATTENZIONE
segnalato con apposito adesivo il foro di fissaggio da non utilizzare in quanto interferisce con il motore di sollevamento

ATTENTION
the fixing hole must not be used as it interferes with the lifting motor and must be marked with a sticker

cavi di alimentazione
power source wiring

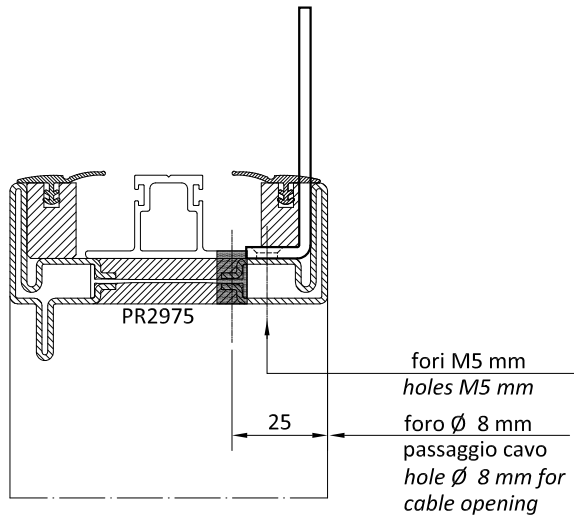

Schema | Type A
Schema | Type B

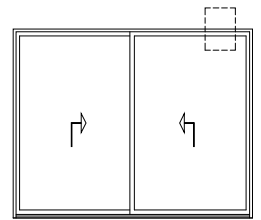

Schema | Type S1

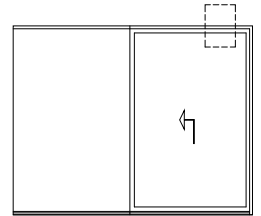

Schema | Type E
Schema | Type F

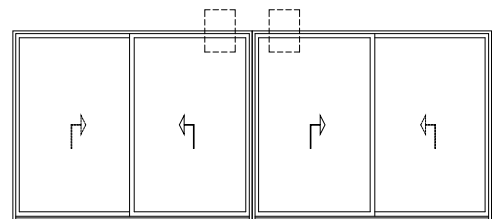

Schema | Type T1

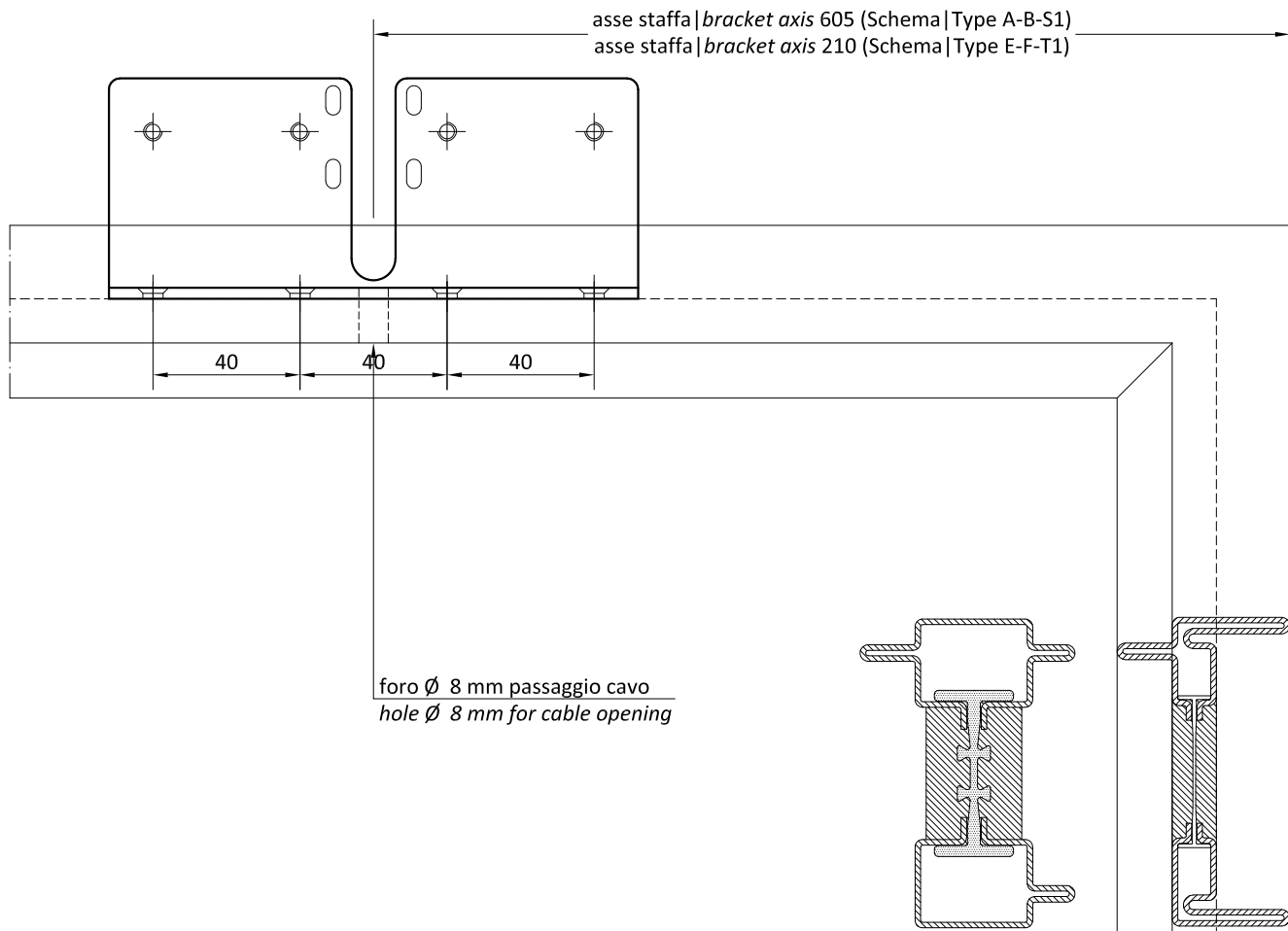
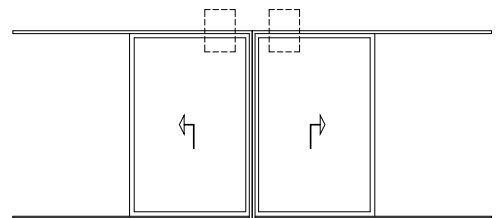

1 ANTA SCORREVOLE ED 1 ANTA FISSA
1 SLIDING AND 1 FIXED SASH

2 ANTE SCORREVOLI
2 SLIDING SASHES

PARTICOLARE "C"
PARTICULAR "C"
≥0 mm <1.5 mm

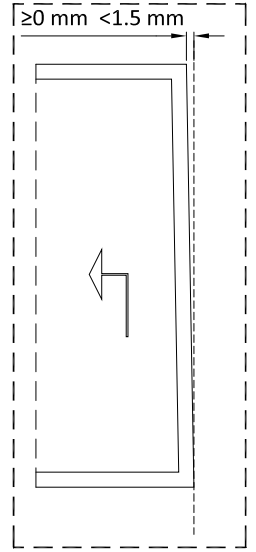
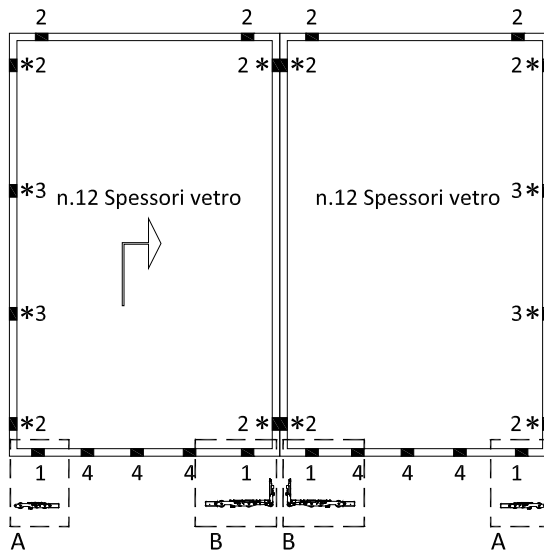
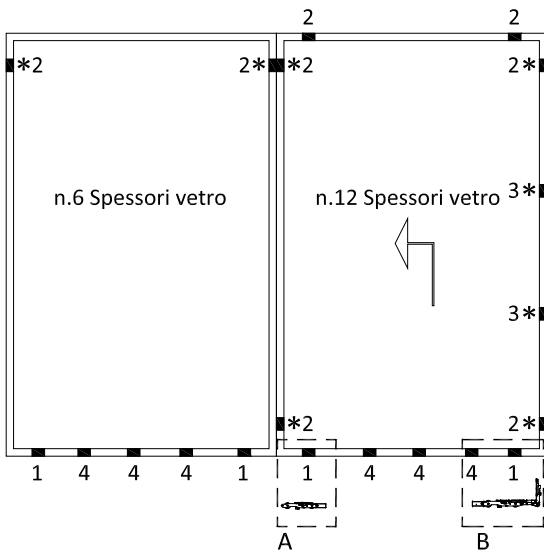

PARTICOLARE "A"
PARTICULAR "A"

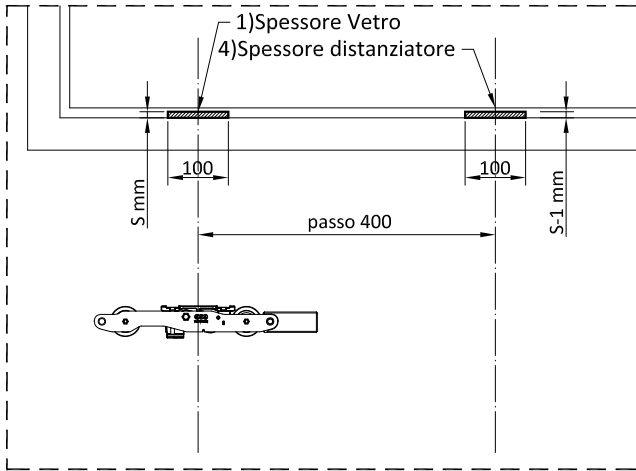

PARTICOLARE "B"
PARTICULAR "B"

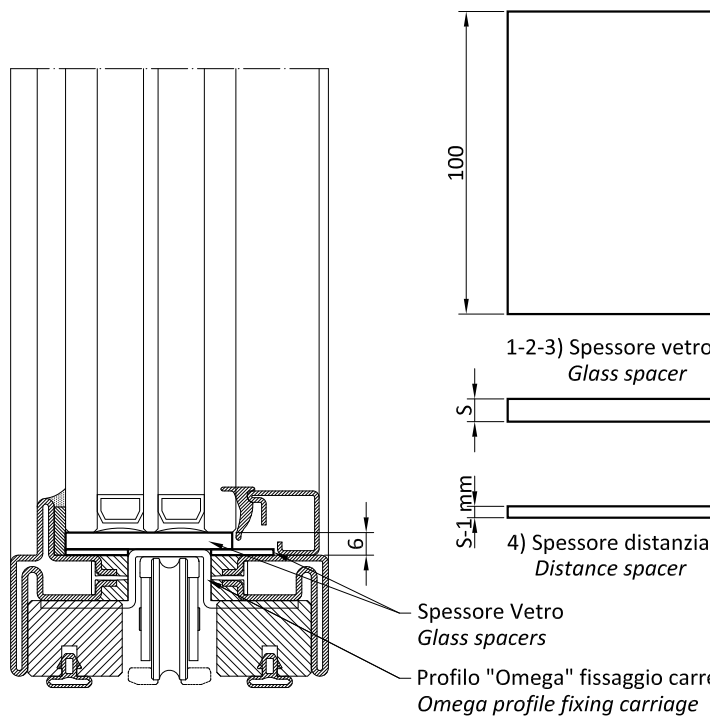
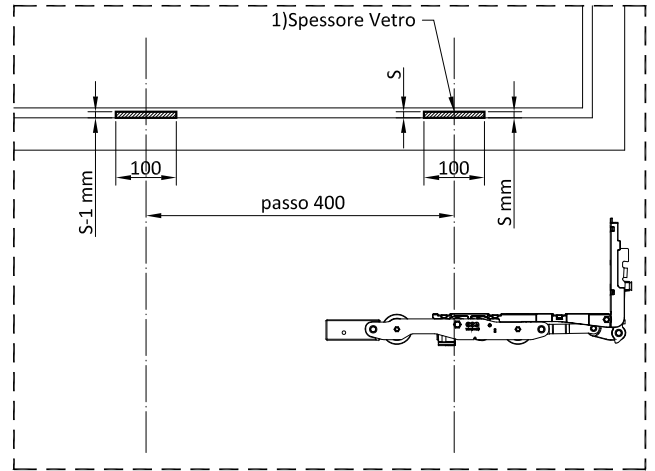

- 1) Spessore portante (allineato ai carrelli dove presenti)
- 2) Spessore distanziatore
- 3) Spessore distanziatore per punti di chiusura
- 4) Spessore distanziatore

- 1) Load-bearing spacer (aligned with carriages if present)
- 2) Distance spacer
- 3) Distance spacer for locking points
- 4) Distance spacer

* Verticalmente fissare spessore vetro con Silicone

* Attach glass spacer vertically with Seal

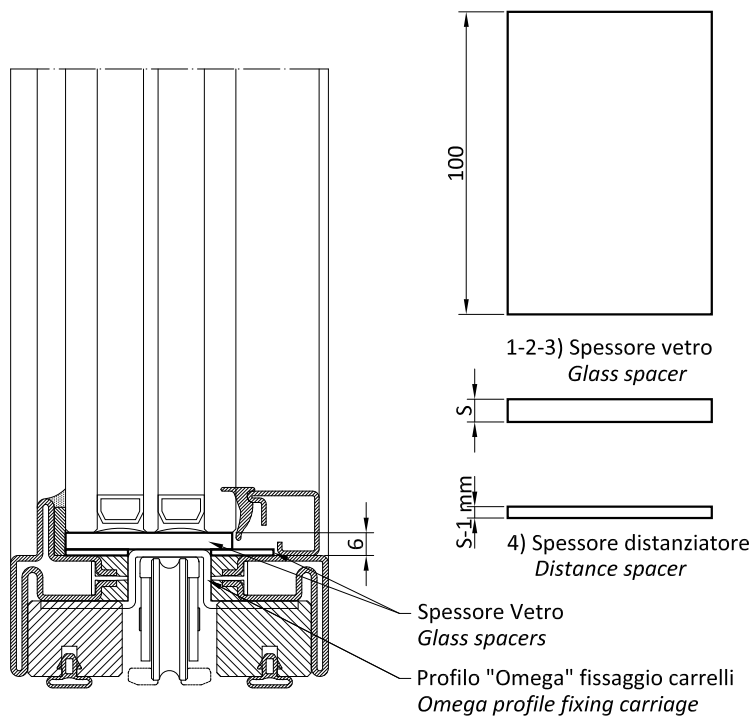
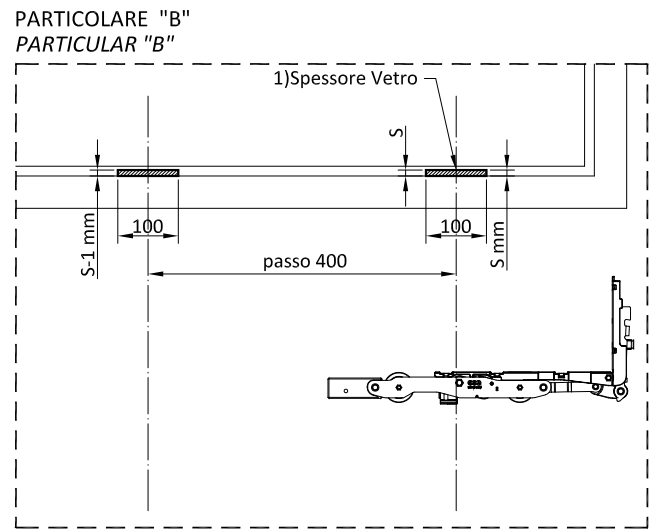
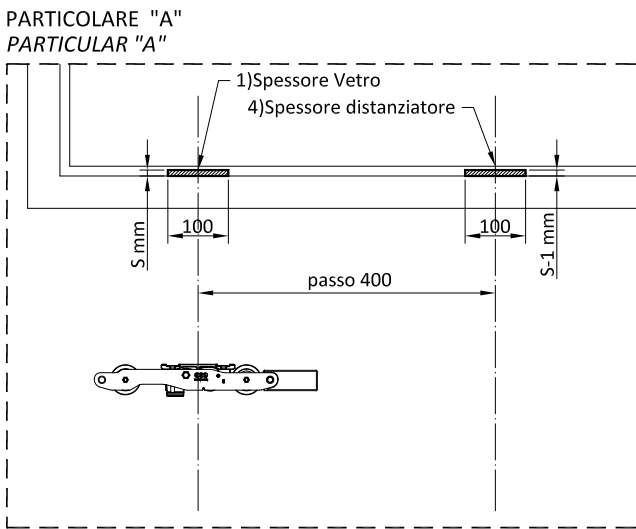
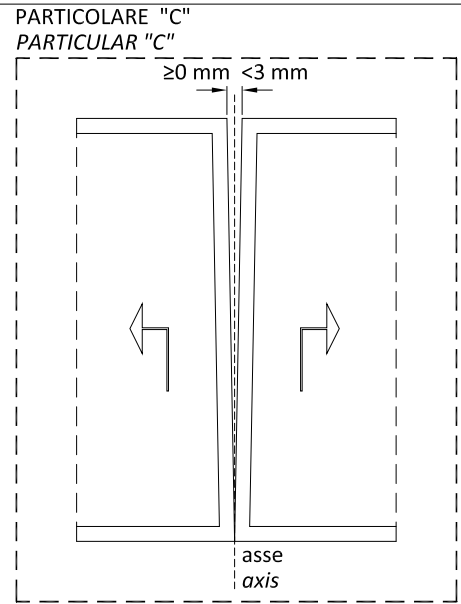
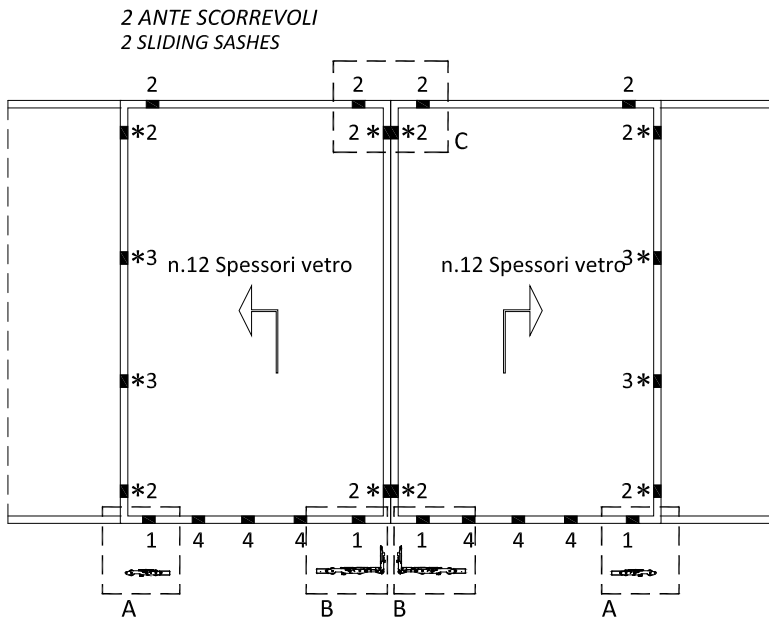

- 1) Spessore portante (allineato ai carrelli dove presenti)
- 2) Spessore distanziatore
- 3) Spessore distanziatore per punti di chiusura
- 4) Spessore distanziatore

- 1) Load-bearing spacer (aligned with carriages if present)
- 2) Distance spacer
- 3) Distance spacer for locking points
- 4) Distance spacer

* Verticalmente fissare spessore vetro con Silicone

* Attach glass spacer vertically with Seal

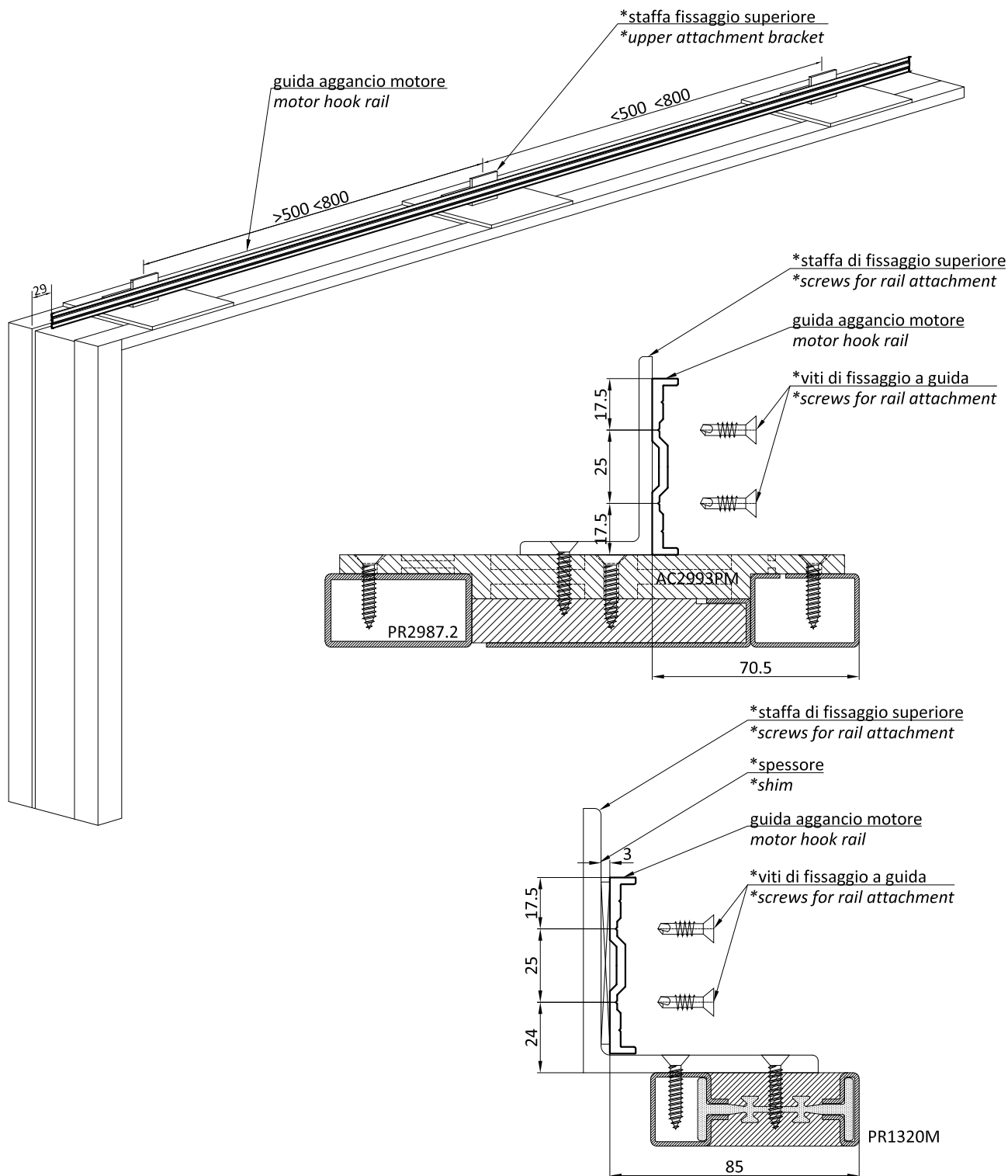
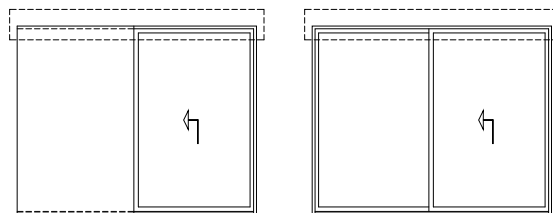

*non fornito | not supplied



Generalità

I sistemi progettati e sviluppati dalla Secco Sistemi sono idonei per la fabbricazione di un'ampia gamma serramenti, vetrate e facciate in metallo. I sistemi sono rivolti ad aziende esperte e professionali nel campo della lavorazione dei metalli e della costruzione di serramenti e facciate, che sono a conoscenza delle normative di riferimento, delle direttive e delle specifiche tecniche del fornitore del sistema, nonché delle fondamentali regole dell'arte per la produzione e installazione di questi manufatti. Tutta la documentazione tecnica fornita costituisce un riferimento per i tecnici qualificati delle aziende al fine di indicare le modalità per la costruzione dei prodotti. In ogni caso i tecnici qualificati devono analizzare criticamente le indicazioni riportate per verificarne la loro adeguatezza per ogni singola commessa in relazione ai carichi, agli stress previsti e alle condizioni di messa in opera, essendo impossibile riportare in questa documentazione tutte le varianti riscontrabili nei progetti reali.

Tolleranze

OS2 75 AS 2.0 prevede l'accoppiamento tra i telai esterni e le ante apribili con distanza di 4 mm nei giunti laterali e di 3 e 14 mm nei giunti inferiore e superiore. Per garantire il corretto funzionamento degli accessori e delle guarnizioni le lavorazioni devono essere eseguite con particolare attenzione e precisione: si consiglia di mantenere la tolleranza per la dimensione degli elementi apribili compresa tra +0/-1 mm.

Taglio/Lavorazioni

I profili OS2 75 AS 2.0 in acciaio zincato, acciaio inox e corten possono essere tagliati con le normali troncatrici a disco utilizzate per i tubolari in acciaio, mentre per il taglio dei profili in ottone possono anche essere utilizzate troncatrici per le serie di alluminio. Vista la loro particolare dimensione e forma si consiglia di utilizzare le ganasce di taglio previste dal sistema per assicurare una perfetta stabilità dei profili durante il taglio. La verifica del taglio, sia per la sezione inclinata a 45° che per la sezione verticale a 90°, dovrebbe garantire una tolleranza compresa tra -1°/+1°. Tutte le lavorazioni devono essere eseguite con il rispetto della seguente nota tecnica ed eventuali modifiche concordate con l'ufficio tecnico Secco Sistemi.

Saldatura

I profili OS2 75 AS 2.0 possono essere saldati con i tradizionali sistemi di saldatura (MIG/MAG, TIG), con un idoneo sistema di lubrificazione/refrigerazione e utilizzando le istruzioni presenti nella presente nota tecnica ed evitando di saldare in prossimità della giunzione a taglio termico. L'eventuale riscaldamento del poliuretano libera sostanze gassose a base di aldeidi e CO: per tale ragione si consiglia di saldare con gli appositi DPI previsti e in zone con sufficiente areazione e in presenza di sistema per l'evacuazione dei fumi. I profili in corten devono essere saldati con apposito filo in corten mentre per i profili in ottone si può utilizzare un filo CuSi3. Si raccomanda di saldare in profondità e senza lasciare fori e porosità le aree in contatto, di lisciare e pulire adeguatamente la superficie saldata per garantire una corretta resistenza strutturale all'angolo e permettere una successiva verniciatura senza imperfezioni estetiche visibili (pori e ondulazioni).

Verniciatura/Brunitura

I profili OS2 75 AS 2.0 sono stati progettati per essere verniciati a polveri in forni con temperature di 180°C per 25 minuti. La zona a taglio termico in poliuretano non è in grado di accogliere con sufficiente adesione le polveri poliesteri e perciò si consiglia di ricoprire tali zone, nelle sole parti destinate ad essere in vista, con apposite pellicole adesive idonee al passaggio in forno. I telai prima della verniciatura o della brunitura devono essere forati come da istruzioni presenti in questa nota tecnica per permettere la fuoriuscita dei liquidi utilizzati durante il pretrattamento delle superfici. All'uscita del forno di polimerizzazione della polvere i telai vanno rimossi accuratamente e adagiati in posizione piana sino al loro completo raffreddamento. Si consiglia di seguire il ciclo di pretrattamenti e verniciatura presente nella documentazione Secco Sistemi.

Vetrazione

Il sistema di fissaggio del vetro prevede l'utilizzo di fermavetri agganciati all'interno tramite clips interne e mandati in pressione con l'incastro dell'apposita guarnizione interna; all'esterno è previsto l'utilizzo di una guarnizione perimetrale continua giuntata e sigillata in un angolo superiore o di una guarnizione butilica di fondo giunto e un cordolo di silicone applicato secondo le prescrizioni tecniche del fornitore del prodotto. Per il corretto funzionamento del sistema si suggerisce di verificare la perfetta compressione delle guarnizioni interne del fermavetro.

Installazione

La corretta installazione deve garantire il mantenimento delle performance dichiarate nella marcatura CE e testate in laboratorio. Si consiglia di progettare un corretto numero di fissaggi in relazione al tipo di controtelaio/muratura esistente e alle dimensioni degli elementi da installare. Al termine dell'installazione si verifichi il corretto funzionamento del serramento (facilità di apertura/chiusura, stabilità dell'anta aperta a riposo, etc.), il rispetto delle distanze tra ante apribili e telai fissi, il regolare posizionamento delle guarnizioni e delle sigillature e la mancanza di difetti estetici sulle superfici dei telai e del vetro.

General information

The systems designed and developed by Secco Sistemi are suitable for the manufacturing of a wide range of doors, windows and shutters, as well as faces or facades in metal. The systems are designed for professional and expert companies in the metal-working sector and that of construction of doors, windows, shutters and facades. These companies are well aware of the specific regulations and the directions and technical specifications of the system supplier, and also the fundamental rules of the art of manufacturing and installing these products. All the technical documentation provided furnishes a source of reference for the qualified technicians of the companies, giving indications as to how the products should be constructed. These qualified experts must critically analyse the indications to verify their adequacy for each single order in terms of load, stress and conditions of installation, particularly as this documentation cannot provide for all the different variations that may be found in projects.

Tolerance

OS2 75 AS 2.0 is made by coupling external frames with the opening leaves with a distance of 4 mm in lateral joint and 3 mm or 14 mm in the lower and upper joint. To ensure the correct functioning of hardware and gaskets, tooling must be performed with great care and precision. It is advised to keep the tolerance between +0/-1 mm for opening elements.

Cut / Processing

OS2 75 AS 2.0 profiles in galvanized steel, stainless steel and corten steel can be cut with normal saws, like those used for steel pipes. OS2 75 AS 2.0 profiles in brass can be cut with saws used for aluminium. Given their dimension and size, it is recommended to use the cutting jaws advised to ensure perfect stability during the cutting procedure. In order to verify the correctness of the cut, the tolerance of both the 45° and the 90° sections must be between -1°/+1°. All Tooling must be performed in line with this technical note and any variations agreed with Secco Sistemi's Technical Department.

Welding

OS2 75 AS 2.0 profiles can be welded with the traditional systems (MIG/MAG, TIG), with an appropriate lubricating/cooling system and according to the instructions as per this technical note. Avoid welding near the thermal break joint. Heating any polyurethane items releases gaseous substances containing aldehydes and CO. For this reason it is recommended to weld with the special Personal Protective Equipment suggested and in areas with sufficient ventilation and fume-disposing systems. The corten profiles must be welded with special corten wire, while for profiles in brass a CuSi3 wire can be used. It is recommended to weld in depth, to avoid leaving any holes or porosity on the surfaces and to smooth and clean the welded surface thoroughly. This is to guarantee a proper structural resistance at the corner and to allow for later painting without any visible imperfections (pores and ripples).

Painting/Burnishing

OS2 75 AS 2.0 profiles have been designed to be painted with the powder coating technique in industrial ovens at temperatures of 180°C for 25 minutes. The thermal break area is not designed to absorb polyester powders and therefore it's advised to cover the visible areas with appropriate industrial-oven-resistant adhesive films (SA1024 and SA1033). Holes must be drilled in the frames (as per instructions in these technical specifications) before painting or burnishing in order to allow drainage of any liquid used as a pre-treatment of the surfaces. Once out of the oven, the frames must be accurately removed and laid in a horizontal position until complete cooled.

It is advised to follow pre-treatment and painting cycles as outlined in the Secco Sistemi documentation.

Glass application

Glass needs to be secured internally and externally. Internally, glazing beads must be used together with clips then secured by pressure with the appropriate gasket; externally a continuous perimetrical gasket should be applied, jointed and sealed in a top corner or a butyl seal and a thread of silicone that must be applied according to the product supplier's technical specifications. In order to ensure the correct functioning of the system, it is recommended to verify the proper pressurization of the internal glazing bead gaskets.

Installation

Proper installation must guarantee that the performances declared in the EC marking and verified in the lab will remain constant. It is advised to arrange a correct series of set ups with reference to the existing type of subframe/brickwork and to the dimensions of the elements to install. Once installation is completed, the proper functioning of the window/door (easiness of opening/closing, stability of the open leaf, etc.), should be tested as well as the correctness of joints and overlapping areas between opening leaves and fixed frames, the proper positioning of gaskets and seals, the drainage of frames with weep system and the absence of any aesthetic defects on the frame and glass surfaces.

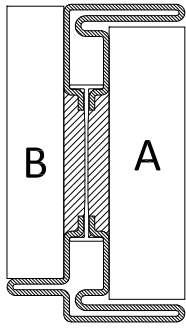

PR2975

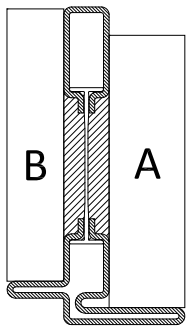

PR2988

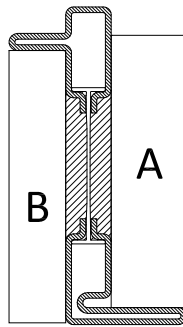

PR2989

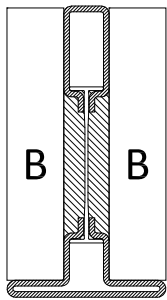

PR2952

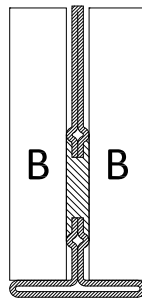

PR2954

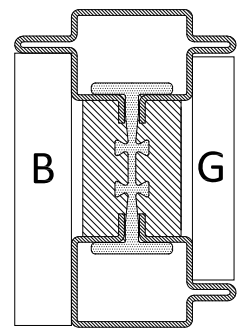

PR2995E

AT2900

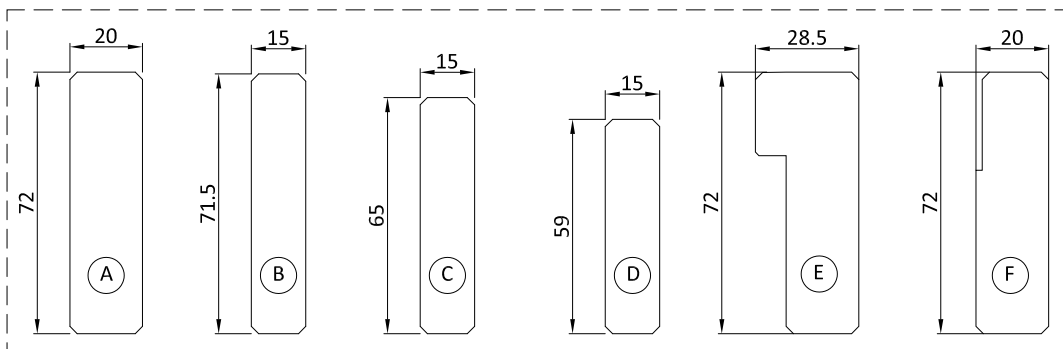

AT2995N

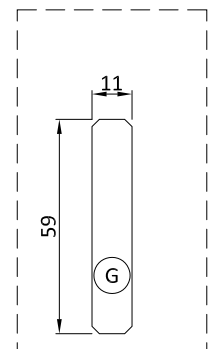

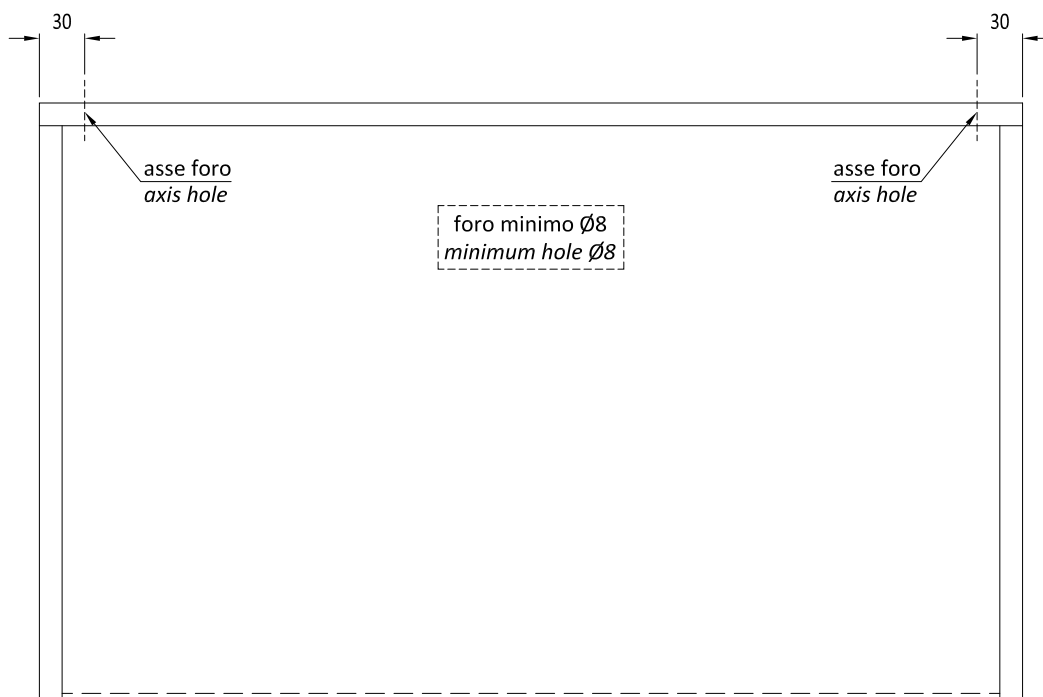
telaio | *frame*

N.B. dimensioni orientamento telai indicative - da verificare con l'impianto di verniciatura/brunitura scelto

N.B. frame dimensions are indicative - they have to be checked with the powder painting / burnishing plant

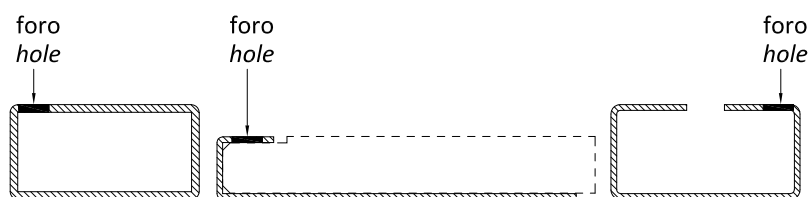

PR2986

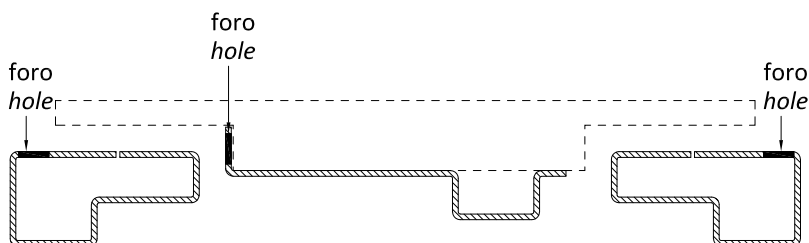

PR2986N

anta | sash

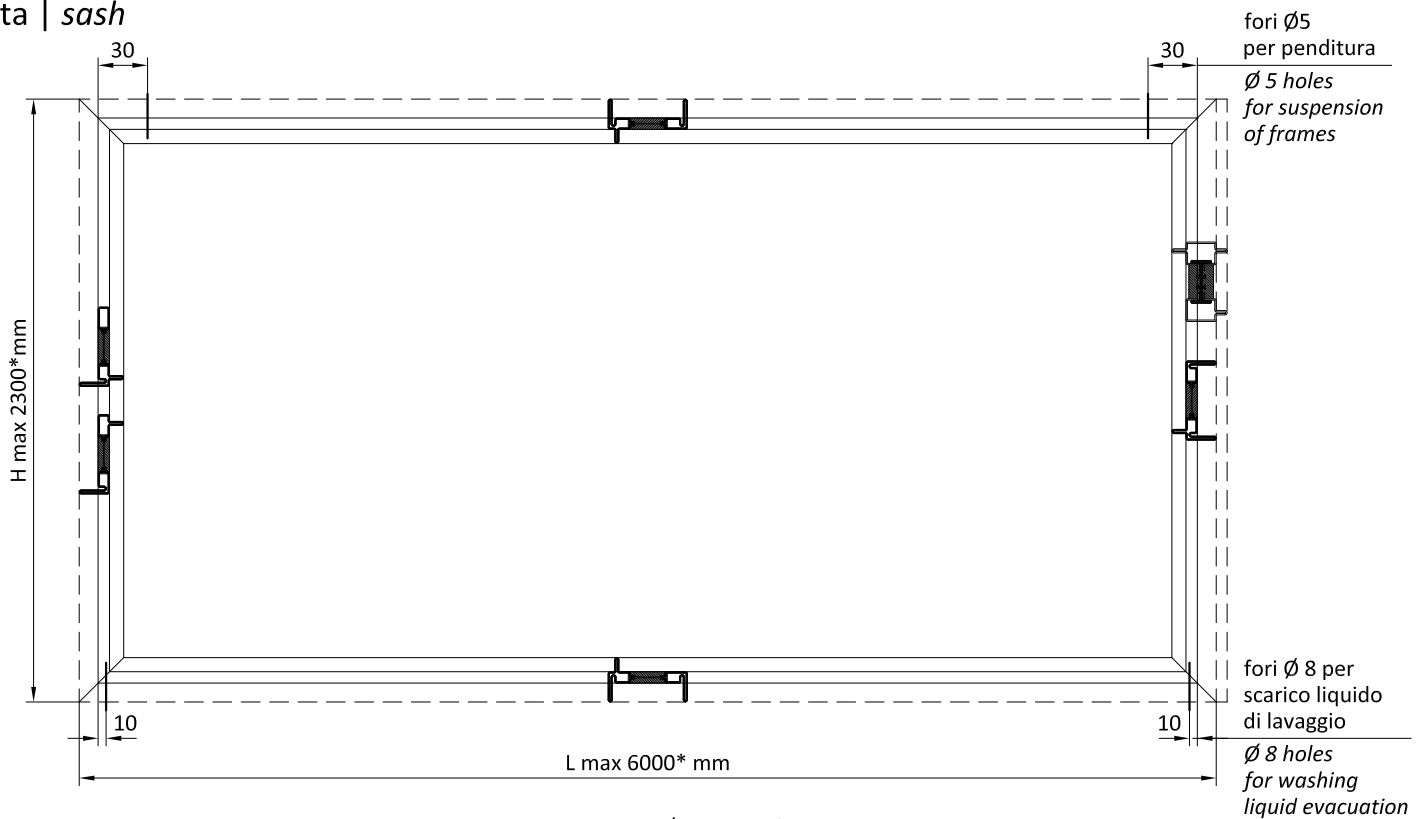

Fori Ø5 per pendinatura
telai con peso inferiore a 40 kg
Ø 5 holes for suspension
of frames not heavier than 40 kg

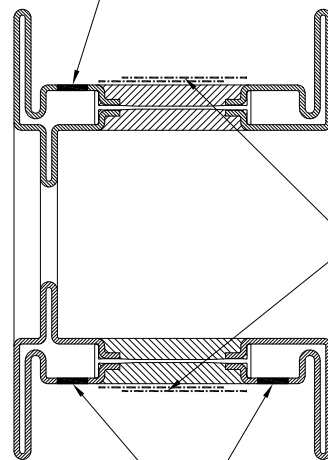

SOLO PER VERNICIATURA
Nastro adesivo protettivo da
25 mm resistente alle alte
temperature (220-230°)
ONLY FOR PAINTING
Protective 25 mm tape resistant
to high temperatures (220-230°)

Fori Ø8 per lo scarico del
liquido di lavaggio
Ø 8 holes for washing
liquid evacuation

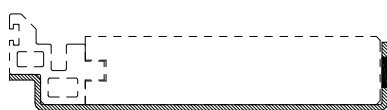

Fori Ø5 per pendinatura
Ø 5 holes for suspension

SOLO PER BRUNITURA

Preparare il profilo da trattare pulendolo con una paglietta tipo Scotch Brite in modo da ottenere superfici lucide e uniformi.

Movimentare il prodotto carteggiato con cautela per non danneggiare la finitura superficiale e non toccare a mani nude il profilo per ottenere un trattamento di brunitura uniforme.

ONLY FOR BURNISHING

Prepare the profile grinding it with a Scotch Brite wool in order to obtain uniform surfaces.

Ease profiles carefully to avoid any damages on the surface as well as do not touch it with hands to allow an uniform burnishing.

* Dimensioni massime disponibili nell'impianto di Secco Sistemi

* Maximum available size in the Secco Sistemi plant

Troncatricecaratteristiche minime della macchina

- Potenza: 1.8 – 2.5 kW;
- Possibilità di taglio a 45° nei due sensi e a 90°;
- Velocità di taglio ideali: 15-30 giri/min per acciaio inox;
60-90 giri/min per acciaio zincato e corten,
90 giri/min o superiori per bronzo (OT/67);
- Capacità di taglio: 150 x 80 mm a 90°;
100 mm taglio a 45°.

caratteristiche della lama

- Lama da 350 mm con spessore 2.5 mm;
- N° denti: - 300 per tagli a 45°;
- 350 per tagli a 90°;
- Materiale: HSS (verificare materiali di commercio con finiture che migliorano la durata delle lame).

NB: è possibile tagliare la lega OT/67 con le stesse macchine dell'alluminio.

Pantografocaratteristiche minime della macchina

- Mandrino con velocità regolabile 2000-11000 giri/min (per un corretta lavorazione su acciaio inox è necessario operare a n° ridotto di giri < 4000);
- Struttura in ghisa adatta al taglio acciaio;
- Testata pesante per limitare le vibrazioni;
- Chiusura del profilo da lavorare con morse.

caratteristiche minime delle frese

- Materiale: HSS (verificare materiali di commercio con finiture che migliorano la durata delle frese);
- Frese a 4 denti;
- Frese con diametro 5 mm per le lavorazioni di scasso.

Foraturemontaggio componenti di chiusura e movimentazione sui profilati in acciaio inox

- Forare con punte da trapano HSS del diametro indicato sulla corrispondente tavola tecnica;
- Maschiare il foro con vite autofilettante zincocromata avente diametro corrispondente alla vite inox fornita nel kit con l'articolo da montare;
- Posizionamento e fissaggio definitivo dell'articolo con le viti inox in dotazione.

fresatura di cave e asole sui profili inox

- Adoperare macchine (pantografi o fresatrici) adeguate alle lavorazioni dell'acciaio;
- Regolazione del numero di giri max (3000 giri/1');
- Impiego di frese di diametro massimo di 8mm a 4 pale in acciaio HSS;
- Abbondare con la lubrificazione, concentrata sull'utensile;
- Ridurre l'avanzamento fino ad accertare un taglio il più regolare possibile;
- È normale un'usura accelerata dell'utensile.

CutterMinimum requirements for the use of the machine

- Power: 1.8 – 2.5 kW;
- Possibility of cutting at 45° in both directions and at 90°;
- Ideal cutting speed: 15-30 rmp for stainless steel;
60-90 rmp for galvanised and corten steel;
90 rmp or higher for bronze (OT/67);
- Cutting capability: 150 x 80 mm at 90°;
100 mm cut at 45°.

Blade specifications

- 350 mm blade with a 2.5 mm thickness;
- Number of teeth: 300 for 45° cut;
350 for 90° cut;
- Material: HSS (please verify availability of longer lasting material on the market).

Note: OT/67 alloy can be cut with machines made for aluminum.

PhantographMinimum requirements for the use of the machine

- Mandrel with a 2000-11000 rmp adjustable speed (for a proper stainless steel processing a slower speed is required i.e.<4000 rpm);
- Machine should be made of cast iron suitable for steel cutting;
- Heavy head in order to limit vibrations;
- Secure the profile to be processed in jaws.

Minimum requirements for the use of a milling machine

- Material: HSS (please verify availability of longer lasting material on the market);
- Use a 4-tooth milling machine;
- Use a milling machine with a 5-mm diameter for groove processing.

DrillingHow to mount closing and moving components on a stainless steel profile

- Use a HSS drill. The diameter of the drill is indicated in the technical note;
- Thread the hole with self-threading zinc-plated screws with the same diameter as the stainless steel screw provided with the kit;
- Position and secure the item with the stainless steel screws provided.

Milling slots and loops in the profiles

- Use machines designed for steel processing (phantographs or milling machines);
- Max rpm setting (3000 rpm);
- Use milling machines with a diameter no bigger than 8 mm and with 4 HSS steel blades;
- Exceed with lubrication, mainly on the machine;
- Processed slowly until the milling is as clean as possible;
- Expect a fast wearing of the machine.

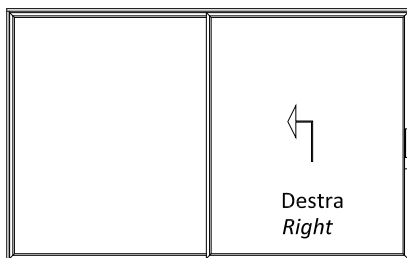
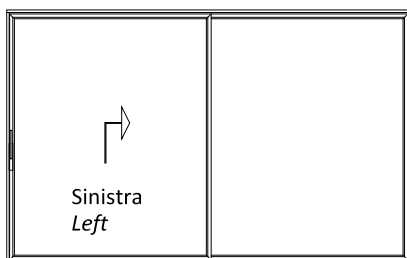
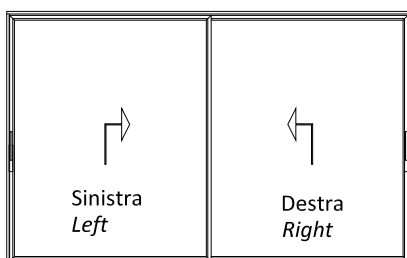
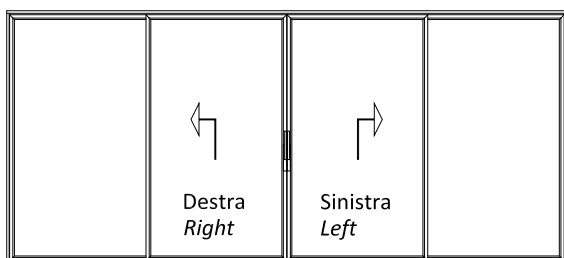
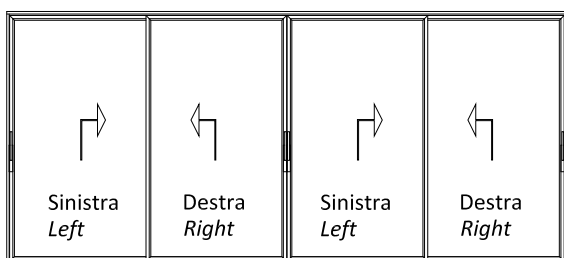
Schema | Type A 1 anta scorrevole ed 1 anta fissa
1 sliding and 1 fixed sashSchema | Type A 1 anta scorrevole ed 1 anta fissa
1 sliding and 1 fixed sashSchema | Type B 2 ante scorrevoli
2 sliding sashesSchema | Type E 2 ante scorrevoli e 2 ante fisse
2 sliding and 2 fixed sashesSchema | Type F 4 ante scorrevoli
4 sliding sashes

vista interna | inside view

Codice Code	Descrizione Description
AG2986A	Kit movimentazione e tenuta 1 anta apribile 1 leaf handling and sealing kit
ACV078	Maniglione singolo Single handle
ACV078Y	Maniglione singolo con cilindro Single handle with hole cilinder
ACV178Y	Maniglione doppio con cilindro Double handle with hole cilinder

Codice Code	Descrizione Description
AG2987A	Kit movimentazione e tenuta 1 anta apribile 1 leaf handling and sealing kit
ACV078	Maniglione singolo Single handle
ACV078Y	Maniglione singolo con cilindro Single handle with hole cilinder
ACV178Y	Maniglione doppio con cilindro Double handle with hole cilinder

Codice Code	Descrizione Description
AG2986B - AG2987B	Kit movimentazione e tenuta 2 ante apribili 2 leaf handling and sealing kit
ACV078	Maniglione singolo Single handle
ACV078Y	Maniglione singolo con cilindro Single handle with hole cilinder
ACV178Y	Maniglione doppio con cilindro Double handle with hole cilinder

Codice Code	Descrizione Description
AG2986E	Kit movimentazione e tenuta 2 ante apribili 2 leaf handling and sealing kit
ACV078	Maniglione singolo Single handle
ACV078Y	Maniglione singolo con cilindro Single handle with hole cilinder
ACV178Y	Maniglione doppio con cilindro Double handle with hole cilinder

Codice Code	Descrizione Description
AG2986F	Kit movimentazione e tenuta 4 ante apribili 4 leaf handling and sealing kit
ACV078	Maniglione singolo Single handle
ACV078Y	Maniglione singolo con cilindro Single handle with hole cilinder
ACV178Y	Maniglione doppio con cilindro Double handle with hole cilinder

Schema | Type S1 1 anta scorrevole a scomparsa
1 sliding sash into the wall

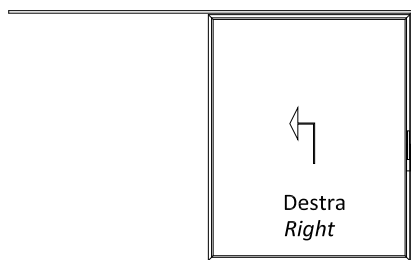

Schema | Type S1 1 anta scorrevole a scomparsa
1 sliding sash into the wall

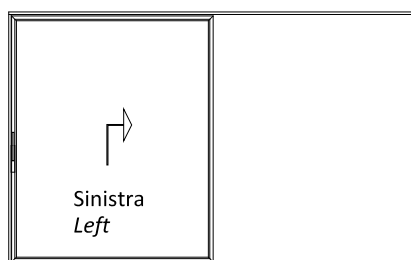

Schema | Type T1 2 ante scorrevoli coassiali a scomparsa
2 coaxial sliding sashes into the wall

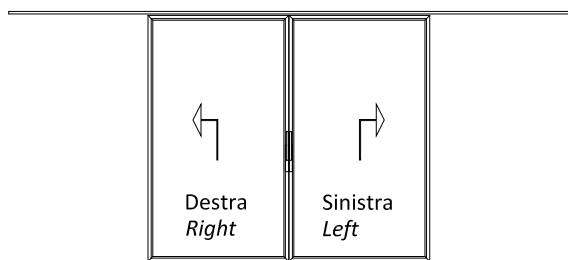

vista interna | inside view

Codice Code	Descrizione Description
AG2986S1	Kit movimentazione e tenuta 1 anta apribile 1 leaf handling and sealing kit
ACV078	Maniglione singolo Single handle
ACV078Y	Maniglione singolo con cilindro Single handle with hole cilinder
ACV178Y	Maniglione doppio con cilindro Double handle with hole cilinder

Codice Code	Descrizione Description
AG2987S1	Kit movimentazione e tenuta 1 anta apribile 1 leaf handling and sealing kit
ACV078	Maniglione singolo Single handle
ACV078Y	Maniglione singolo con cilindro Single handle with hole cilinder
ACV178Y	Maniglione doppio con cilindro Double handle with hole cilinder

Codice Code	Descrizione Description
AG2986T1	Kit movimentazione e tenuta 2 ante apribili 2 leaf handling and sealing kit
ACV078	Maniglione singolo Single handle
ACV078Y	Maniglione singolo con cilindro Single handle with hole cilinder
ACV178Y	Maniglione doppio con cilindro Double handle with hole cilinder

1. Controllo materiale in arrivo / *Incoming equipment Control*
 Verifica visiva dell'intergrità delle barre con attenzione a: / *Profiles wholeness visual control paying attention to:*
 - Strisci profondi / *Deep scratches* verifica visiva / *visual control*
 - Botte e avvallamenti sulla superficie / *Bumps and dips on surface* verifica visiva / *visual control*
 - Rettilinearità barre / *Profiles straightness tolerance* 0,002 x L
 - Svergolamento / *Profiles twist tolerance* 1° x m

2. Taglio barre e controllo barre / *Cut and Control of profiles*
 - Misura lunghezza / *Length measurement* ± 0.5 mm
 - Verifica 45° / *45° Control* ± 1°
 - Verifica 90° / *90° Control* ± 1°

3. Preparazione per verniciatura - brunitura / *Preparation for the powder coating - burnishing*
 - a. Fori su telaio per scarichi liquidi pretrattamento
Holes on frame for the drainage of pretreatment liquid
 - b. Marcatura e imballo telai esterni e ante
External frames and leafs branding and packing
 - c. Marcatura e imballo telai fermavetro
Glazingbeads frames branding and packing
 - d. Marcatura e imballo profili complementari
Additional profiles branding and packing

4. Applicazione accessori e sigillatura / *Hardware and accessories installation and sealing*
 - I. Montaggio cremonese e incontri / *Espagnolette installion*
 - II. Montaggio guarnizioni di battuta / *Gasket installation*
 - III. Sigillatura angolo nel TT / *Corner joint sealing*

5. Vetrazione / *Glazing*
 - a. Applicazione clips fermavetro / *glazing bead clips installation*
 - b. Applicazione guarnizione esterna / *External glazing gasket installation*
 - c. Applicazione vetro (spessoramento) / *Glazing installation (setting blocks)*
 - d. Inserimento fermavetri / *Glazing beads application*
 - e. Inserimento guarnizione interna fermavetro / *Fit glazing bead to glass gasket*
 - f. Verifica corretta compressione guarnizione / *Control of the right compression of the gasket*

6. Controlli su prodotto finito / *Control on finished element*
 - a. Verifica distanza tra anta e telaio /
Control of gap between leaf and frame +0 +0.5 mm
 - b. Verifica sormonto anta su telaio / *Control of leaf surmount* +0 +1 mm
 - c. Verifica sigillature per scarico acqua /
Control of central gasket sealing test con acqua su giunto
test with water
 - d. Verifica funzionamento cremonese/maniglia serratura
Control of hardware functioning
 - e. Verifica finitura superficiale / *Control of surface finishing*

-
7. Controlli dopo la posa / *Controls after installation*
- a. Verifica corretta installazione telai: squadra, piombo, misure /
Control of alignment and plumbing of frame and leaf
 - b. Verifica distanza tra anta e telaio / +0 +1 mm
Control of gap between leaf and frame
 - c. Verifica sigillature per scarico acqua / test con acqua su giunto
Control of central gasket sealing *test with water*
 - d. Verifica funzionamento cremonese/maniglia serratura
Control of hardware functioning
 - e. Verifica finitura superficiale / *Control of surface finishing*

MATERIALI**ACCIAIO INOX****Materiale**

Profilati ricavati da nastro di lamiera di acciaio inox laminato a freddo pre-trattato industrialmente per garantire la massima qualità e uniformità.

Caratteristiche fisiche

AISI 316L Marino (X2 CrNiMo 17-12-2)

Norme di riferimento

EN 10088-2; EU 114

Trattamenti superficiali

Finitura Scotch Brite: ottenuta su nastro AISI 316L (marino) con finitura superficiale 2B con successiva spazzolatura Scotch Brite.

ACCIAIO COR-TEN**Materiale**

Profilati ottenuti da nastro in acciaio altoresistenziale, autopassivante (che un tempo veniva commercializzato con il nome Cor-Ten) tale da formare, se esposto all'aria, uno strato di ossido uniforme e stabile che, ricoprendo la lamiera, ne arresta la corrosione atmosferica.

Caratteristiche fisiche

Fe 510 X (C max % 0,12; Si % 0,25-0,75; Mn % 0,20-0,50; P % 0,07-0,15; Cu % 0,25-0,55; Cr % 0,30-1,25; Ni max % 0,65)

Norme di riferimento

EN 10149

Trattamenti superficiali

Dopo la profilatura il materiale viene immerso in speciali bagni ossidanti tali da accelerare la formazione dello strato protettivo. Raggiunta la tonalità desiderata della superficie si procede ad una ceratura di stabilizzazione del materiale.

ACCIAIO ZINCATO VERNICIATO**Materiale**

Profilati ottenuti da nastro in lamiera di acciaio zincato a caldo sistema Sendzimir finitura skinpassata

Caratteristiche fisiche

FeP02 GZ 200

Norme di riferimento

UNI EN 10142/3/7; EURONORM 143

Trattamenti superficiali per la verniciatura

La preparazione del supporto zincato si effettua tramite i processi di sgrassaggio, decapaggio e lavaggio in acqua. Segue l'applicazione di uno strato di zinco per fosfatazione seguito da lavaggi in acqua demineralizzata. Infine applicazione della mano a finire con polveri poliestere cotte in forno a 180 °C per 25 minuti.

LEGA DI RAME OT67**Materiale**

Profilati ottenuti da nastro di Lega di Rame OT67 laminato a freddo rincrudito allo stato grezzo.

Caratteristiche fisiche

Cu Zn 33 CW 506L (OT 67, 67% rame e 33% zinco)

Norme di riferimento

EN 1652:1999

Trattamenti superficiali

Finitura brunita: dopo la profilatura viene eseguita una ricottura di distensione, quindi la pulitura meccanica con abrasivo e la successiva brunitura per immersione con liquido brunitore; il profilo viene poi lavato e asciugato ed infine protetto mediante trattamento con olio di vaselina.

Finitura lucida: dopo la profilatura viene eseguita una ricottura di distensione e successivamente la lucidatura a specchio.

MATERIALS**STAINLESS STEEL****Materials**

Sections processed out of the cold-rolled coils, industrially pre-treated for utmost quality and uniformity.

Physical features

AISI 316L Marino (X2 CrNiMo 17-12-2)

Norms of reference

EN 10088-2; EU 114

Surface treatment

Scotch Brite: obtained on AISI 316L (marine) coil 2B pre-finish with Scotch-Brite post-scrubbing.

CORTEN STEEL**Materials**

Sections processed out of highly resistant self-oxidising steel coils – once traded under the name Cor-Ten. If exposed to the open air, it produces a uniform protective layer that reduces weather corrosion.

Physical features

Fe 510 X (C max % 0,12; Si % 0,25-0,75; Mn % 0,20-0,50; P % 0,07-0,15; Cu % 0,25-0,55; Cr % 0,30-1,25; Ni max % 0,65)

Norms of reference

EN 10149

Surface treatment

After forming, sections are plunged into a special oxydising bath to catalyze formation of the protective coating. Once the desired tone obtained, sections are stabilized by a wax coating.

GALVANIZED AND PAINTED STEEL**Materials**

Sections processed out of hot galvanized steel coils, band "Sendzimir, skinpassed finishing.

Physical features

FeP02 GZ 200

Norms of reference

UNI EN 10142/3/7; EURONORM 143

Pre-painted surface treatment

The preparation of a galvanised surface is made through several processes: degreasing, pickling and washing. A coating of zinc is then applied through a phosphatising process followed by rinses in demineralised water. A final coat is then applied with polyester powders baked at 180 °C for 25 minutes.

COPPER ALLOY OT67**Materials**

Sections processed out of copper alloy coils, industrially cold-rolled.

Physical features

Cu Zn 33 CW 506L (OT 67, 67% copper and 33% zinc)

Norms of reference

EN 1652:1999

Surface treatment

Burnished finish: after forming, the product is submitted to stress relieving, then to mechanical cleaning with abrasive products and ultimately to burnishing by plunging into a burnishing solution. It is then washed and dried and protected with a vaseline coating.

Glossy finish: after forming, the product is submitted to stress relieving and then mirror-like polished.

INDICE ANALITICO | SUBJECT INDEX

AC2608	2.9.1-3 2.9.5
AC2608AR	2.9.1-2 2.9.5
AC2609AR	2.9.3 2.9.5
AC2895N	4.3.4 4.3.6
AC290ANT	4.3.4-5
AC298TES	4.2.3
AC298TSC	4.2.4
AC2993P	4.2.1-2 4.2.15-16
ACV078	4.3.39-41 5.3.1-2
ACV078Y	4.3.40-41 5.3.1-2
ACV178Y	4.3.40 4.3.42 5.3.1-2
AG2986(7)	4.3.7-9 4.3.27-38 5.3.1-2
AT2900	5.1.3
AT2995N	5.1.3
CV1243(I)	2.9.4 2.9.6
CV5012(I)	2.9.4 2.9.6
CV5403I	4.2.7-8
GU2905	4.3.20
GU2955	4.2.2 4.2.23-26 4.3.20
GU2956	4.3.19
GU2975S	4.3.16-17
GU2985I	4.3.15-17 4.3.21
GU2985L	4.3.16
GU2995N	4.3.17
PA1194(NE)	4.2.17-18
MBS	MC.1
MBX	MC.2

METALFORM

MASTERS OF METAL

UNITED KINGDOM

METALFORM

NORWAYMETAL LTD

53 Chelsea Manor Street

London, SW3 5RZ

SALES@METALFORM.UK

+44 20 81298814

GERMANY

METALFORM GMBH

Carl-Zeiss-Ring 15A

85737 Ismaning

SALES@METALFORMGROUP.DE

+49 17663630406

NORWAY

METALFORM AS

Brochmannsveien 2

1950 Rømskog

SALG@METALFORM.NO

+47 401 62 446

METALFORMGROUP

SALES@METALFORMGROUP.COM