

4F

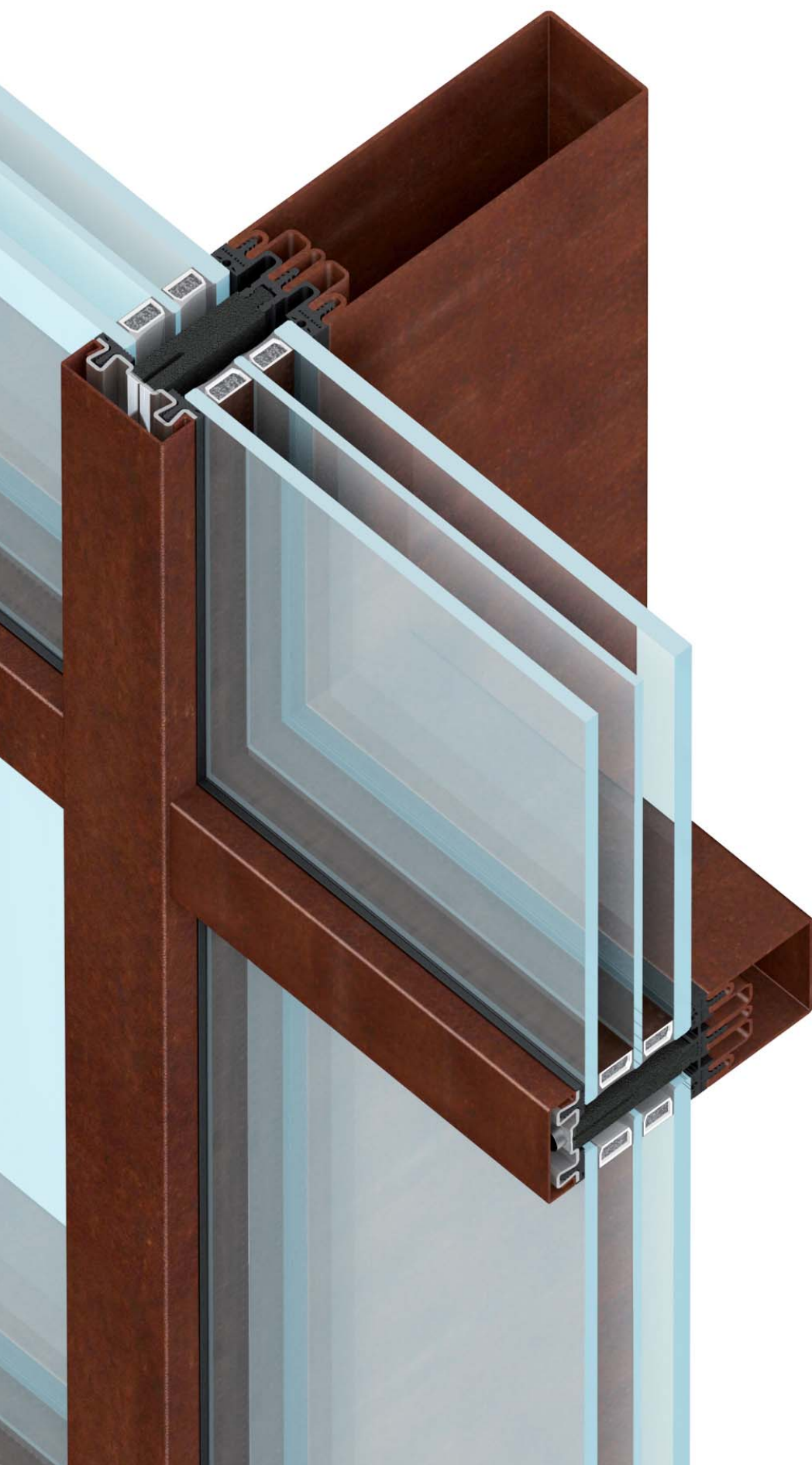

METALFORM

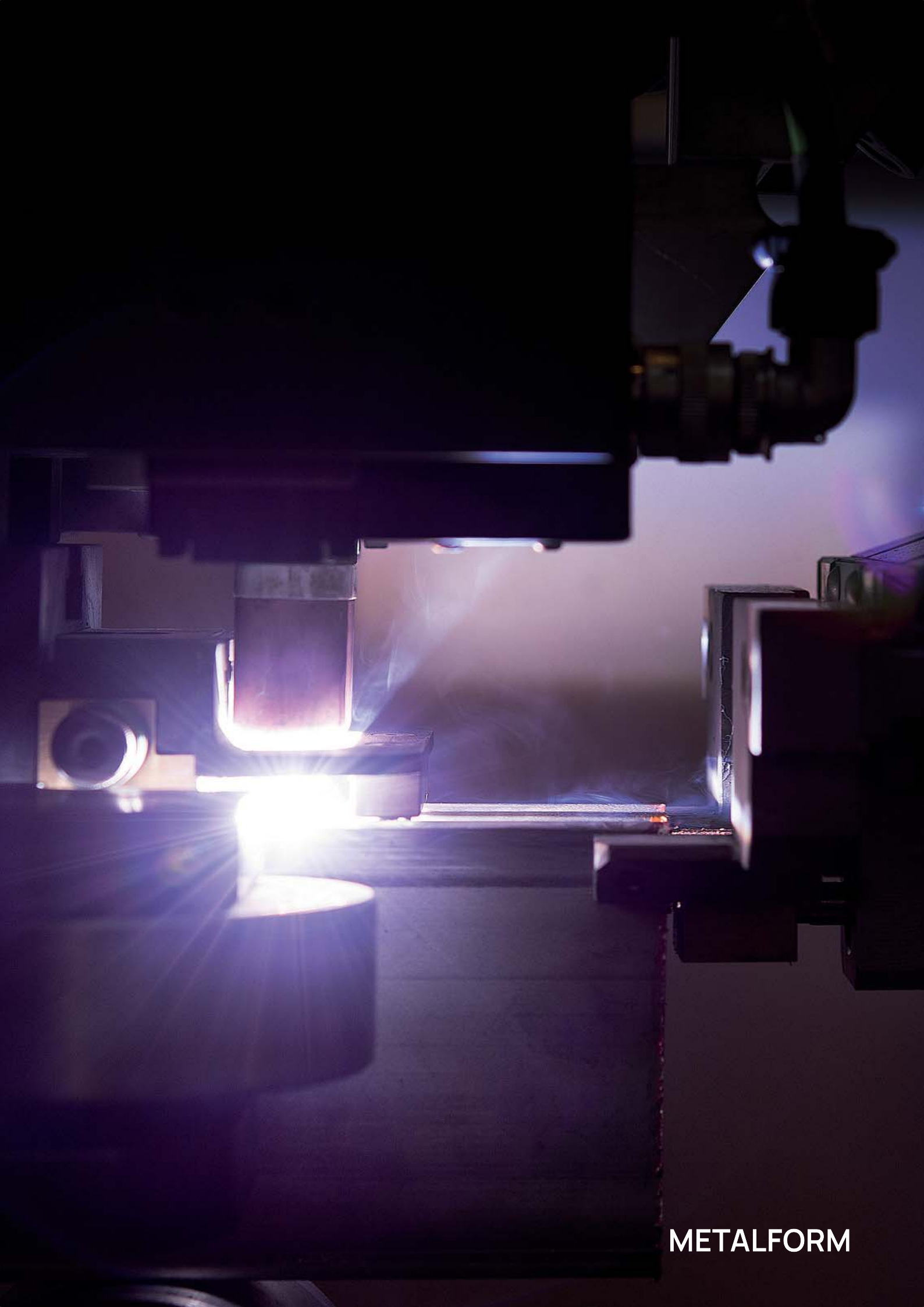

METALFORM

Secco Sistemi is an Italian brand leader in the manufacturing of doors, windows and facades in galvanised steel, stainless steel, Corten steel and brass.

Every year, 2 million linear metres of profile bars are turned into 200.000 doors, windows and facades.

Sixty years of experience and an on-going commitment to the development and innovation of a high-quality product, made the steel curtain wall increasingly competitive. Thin profiles frame the ever wider door and window panels creating a light and flexible system that can be fully integrated with high-performance opening types.



METALFORM



METALFORM



METALFORM

index

	curtain walls	7
values	project	11
	materials	19
	detail	25
	fire	31
	certification and performance	35
	sustainability	39
facade system	4F 1	42
	4F 2	50
technical pages	the reasons for this choice	61
	4F 1	62
	4F 2	64



METALFORM

curtain walls

**the synergy
between industrial
technology and
craftsmanship
ensures living
comfort
and superior
performance**

The steel curtain wall by Secco Sistemi guarantees full compatibility and integration with the architectural design. This solution combines slim profiles, large glass surfaces and a wide range of openings in an integrated door-window-facade system that features structural performance levels three times higher than aluminium and excellent fire resistance. In order to meet the current technical and technological needs of the building envelope, Secco Sistemi leads the entire product design and manufacturing process to offer a complete and rigorous certification based on the transparency of data, thanks to the expertise acquired in the development of galvanised steel, stainless steel, Corten steel and brass windows and doors.

the 6 values

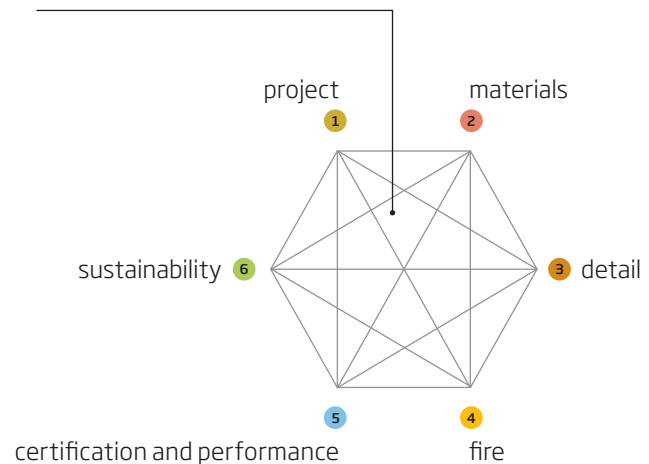

curtain walls

sixty years of experience and expertise in the development of new solutions for steel curtain walls

Secco Sistemi has been working for sixty years on steel industrial processing and transformation to obtain galvanised steel, stainless steel, Corten steel and brass profiles that combine traditional building methods and technological development, thus strengthening its leading position worldwide thanks to its know-how and the quality of its products. The team of Secco Sistemi interprets doors, windows and curtain walls, as a single system able to ensure flexibility in any architectural project, supporting the different interlocutors throughout the careful and accurate management of the entire design and building process: from the most demanding customers and designers, to the most suitable window fabricators for a specific project. Pursuing effectiveness and efficiency, Secco Sistemi is also able to provide tailored solutions for large projects.

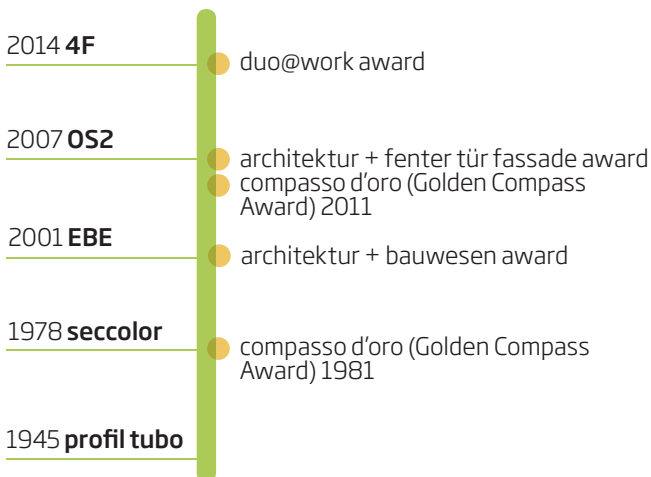

recognised quality and extensive research to meet the needs of an increasingly articulate and rigorous market

Choosing Secco Sistemi means taking part in a globally recognised process of continuous updating and constant innovation. Building on the study of history and the “culture of living”, every research project focuses on the accurate and conscious observation and analysis of existing buildings that, together with a thorough knowledge of standardization and quality certification systems, allow for the development of products able to anticipate the needs of an increasingly demanding market. Excellent performance and superior technical features, along with a careful choice of materials, result in an improved detail design and the adoption of sophisticated technical and aesthetic solutions that ensure visual comfort and perceptual pleasure.

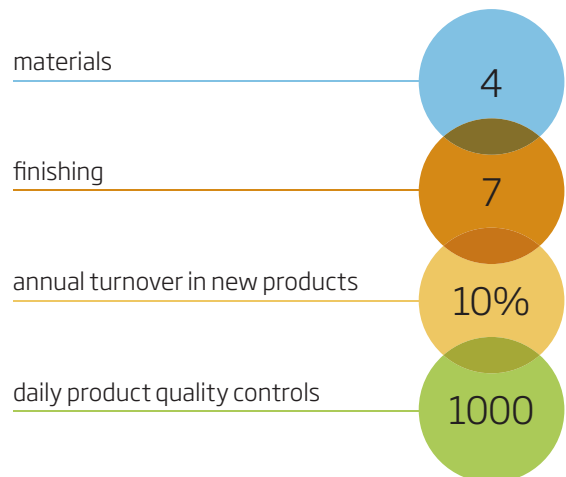

individual testing and superior performance for a certified product that is the result of a search for constant innovation

With the creation of Secco Lab, Secco Sistemi reaffirms its on-going commitment to product quality and innovation. Hence, industrial and technical know-how, proven experience, recognised reliability, continuous quality improvement, and attention to the contemporary context, become the tools available to the protagonists of the entire design and realisation process. Within the company, through dialogue and the mutual exchange of views and thoughts, each and every interlocutor can give their own contribution to the identification of new objectives that are further analysed, possibly resulting in the development of new prototypes. Tests, inspections and certifications complete the product manufacturing process, with a view to promoting the mutual growth of the culture of quality, the principles of which should be disseminated in an increasingly conscious way.

certification and product testing

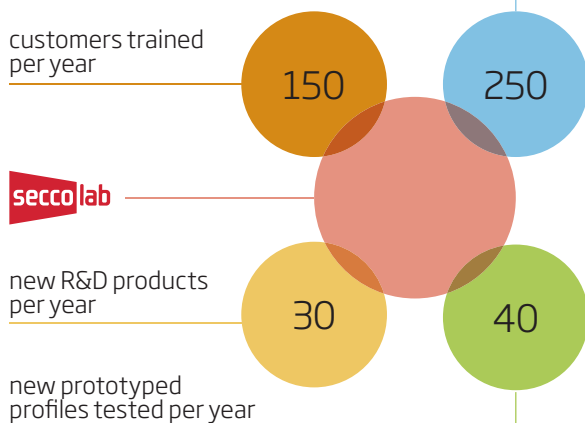

integration of door, window and facade in a single system to ensure greater freedom for any design choice

The steel curtain wall supplied by Secco Sistemi leaves the designer maximum freedom to draw any facade to their liking. Indeed, the versatility of this system allows for the simultaneous use of different frame sizes and various materials and, according to the system requirements, the installation of several types of openings, chosen from the wide Secco Sistemi range. Using four high-quality alloys - galvanised steel, stainless steel, Corten steel and brass - Secco Sistemi offers seven exterior finishes and five interior finishes that allow for greater design flexibility and high levels of customisation in large projects.

integration of the facade system

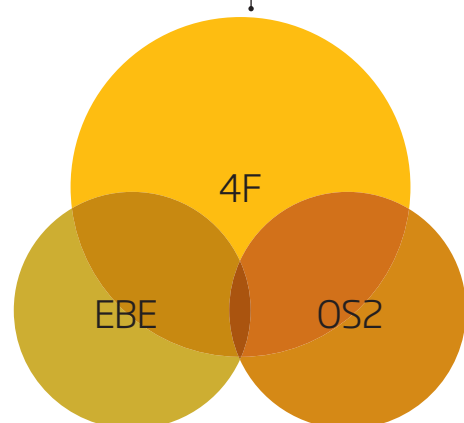



METALFORM

project value

**the diversity
and variability
of a certified
system allow for
the realisation
of larger facade
projects**

The integrated facade, door and window system, by interpreting the features of complexity and transparency of contemporary architecture, provides the designer with more freedom in the design of facades. Mullions up to 8 m, frames of variable thickness -50 mm to 180 mm-, and extremely small sections of 50 mm, ensure flexibility, lightness and reduced visual impact, along with structural efficiency and excellent environmental performance.

Together with high-value products, Secco Sistemi offers a very important service: a team of advisors and qualified technicians help designers give shape to their conceptual - and tailored - solutions for special projects, supporting them throughout the technical and building process, and in the preventive cost assessment, also providing consultancy on rules and regulations, and assistance in the realisation of the works.

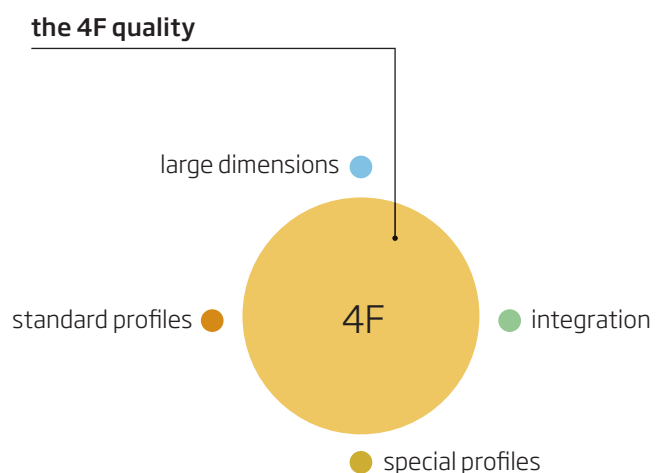

project value

standard profiles and large dimensions

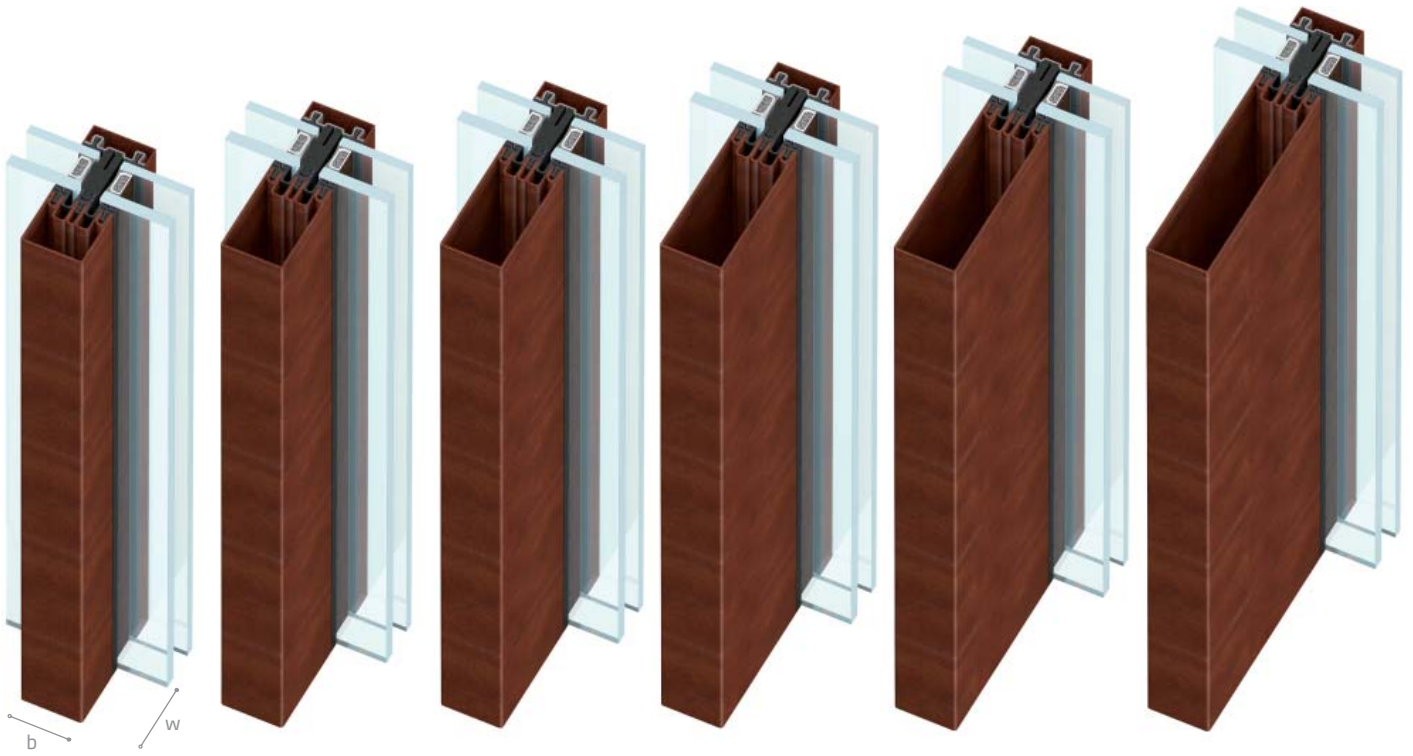

b. 50 mm
w. 50 mm

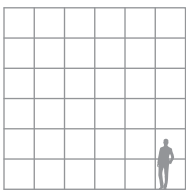

b. 50 mm
w. 80 mm

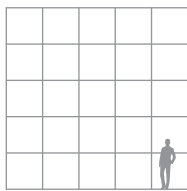

b. 50 mm
w. 100 mm

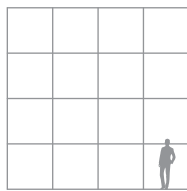

b. 50 mm
w. 120 mm

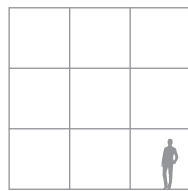

b. 50 mm
w. 150 mm

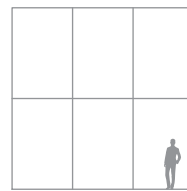

b. 50 mm
w. 180 mm

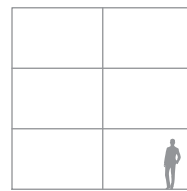

The facade system consists of 6 mullion/transom profiles with a reduced size of only 50 mm. Available in three materials (galvanised steel, stainless steel and Corten steel) they have different lengths, up to 8 m and depths, from 50 mm to 180 mm. By increasing the depth of the profile, it is possible to increase the dimensions of opaque and glass panels up to approximately 7 sqm, thus giving the designer the possibility to choose the profile that best matches their project needs.

integration

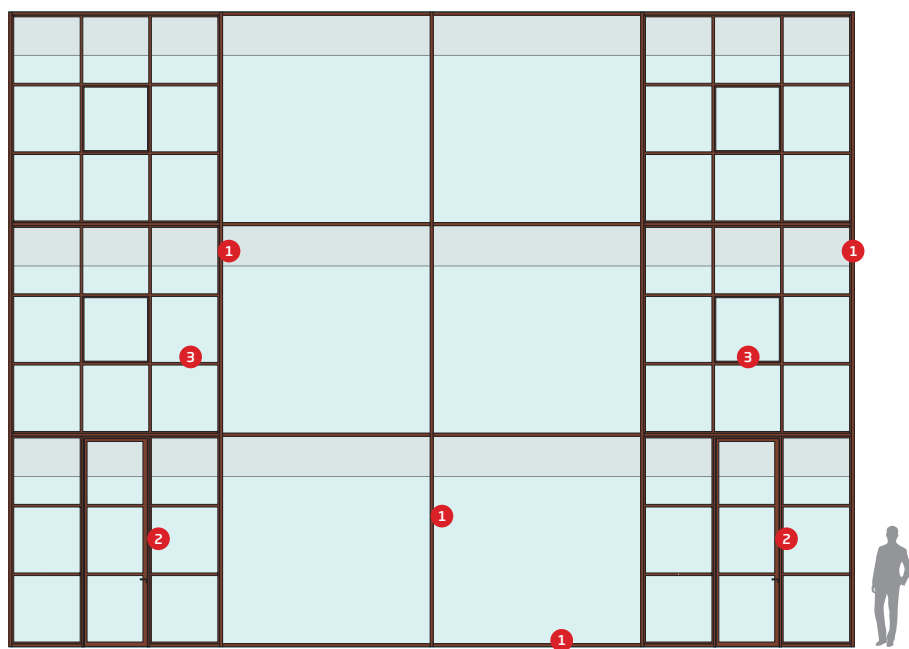
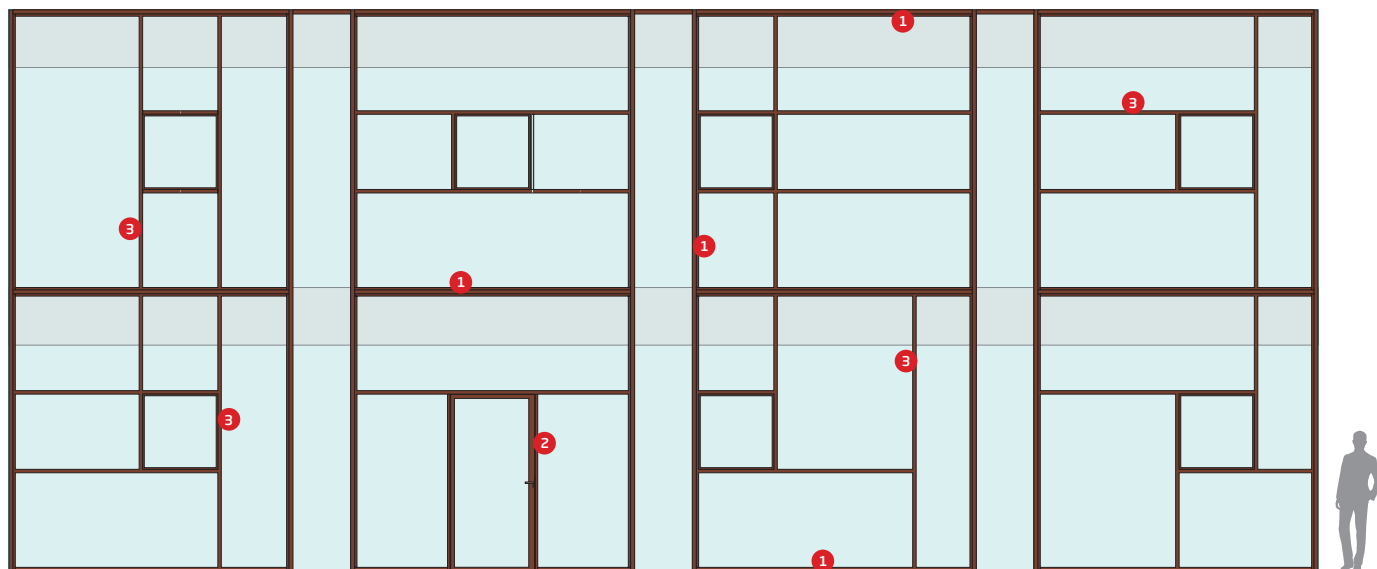

Thanks to Secco Sistemi curtain wall, the designer has maximum freedom in the design of the facade of the building. The versatility of 4 F indeed allows for the adoption of different materials, the combination of different profiles, the installation of several types of panels, as well as the perfect integration with all the door and window frames that can be identified within the wide EBE and OS2 range offered by Secco Sistemi.

project value

special projects - Weill building | Paris (F)

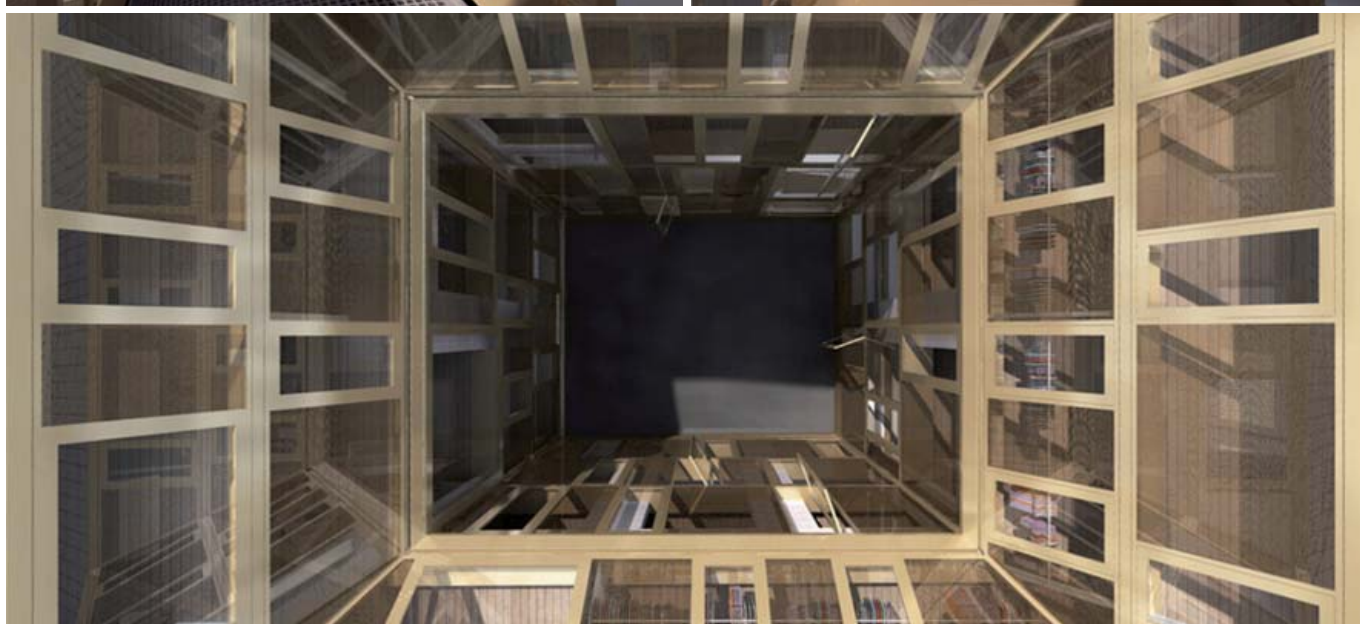

The renovation project of the Weill building, which houses the prestigious Parisian headquarters of the laboratories and departments of the namesake fashion house, gives a new identity to this historic building. The extraordinary collaboration between Secco Sistemi and the architect Jacques Moussafir, brings to life a custom-made solution which, by enhancing the project aesthetic values and paying great attention to details, encases the internal courtyard in a curtain wall made of burnished brass, a noble material able to reflect the elegance of the fashion house, whose excellent environmental performance levels have been certified within Secco Lab.

special profiles - Cetaceans Pavilion | Genoa



Designed by Renzo Piano Building Workshop, fully in line with the structure of the Genoa Aquarium built twenty years earlier, the Cetaceans Pavilion sits in the Porto Antico area and has minimum visual impact thanks to the wide glass surface on the south side and the visitors' path, which is 30 m long and rises only 3 m above sea level, that allows visitors to watch the mammals. Catwalk and curtain wall systems, realised with special stainless steel profiles and integrated with the OS2 range of doors and windows by Secco Sistemi, combine optimal technological performance and lightness.



METALFORM



METALFORM

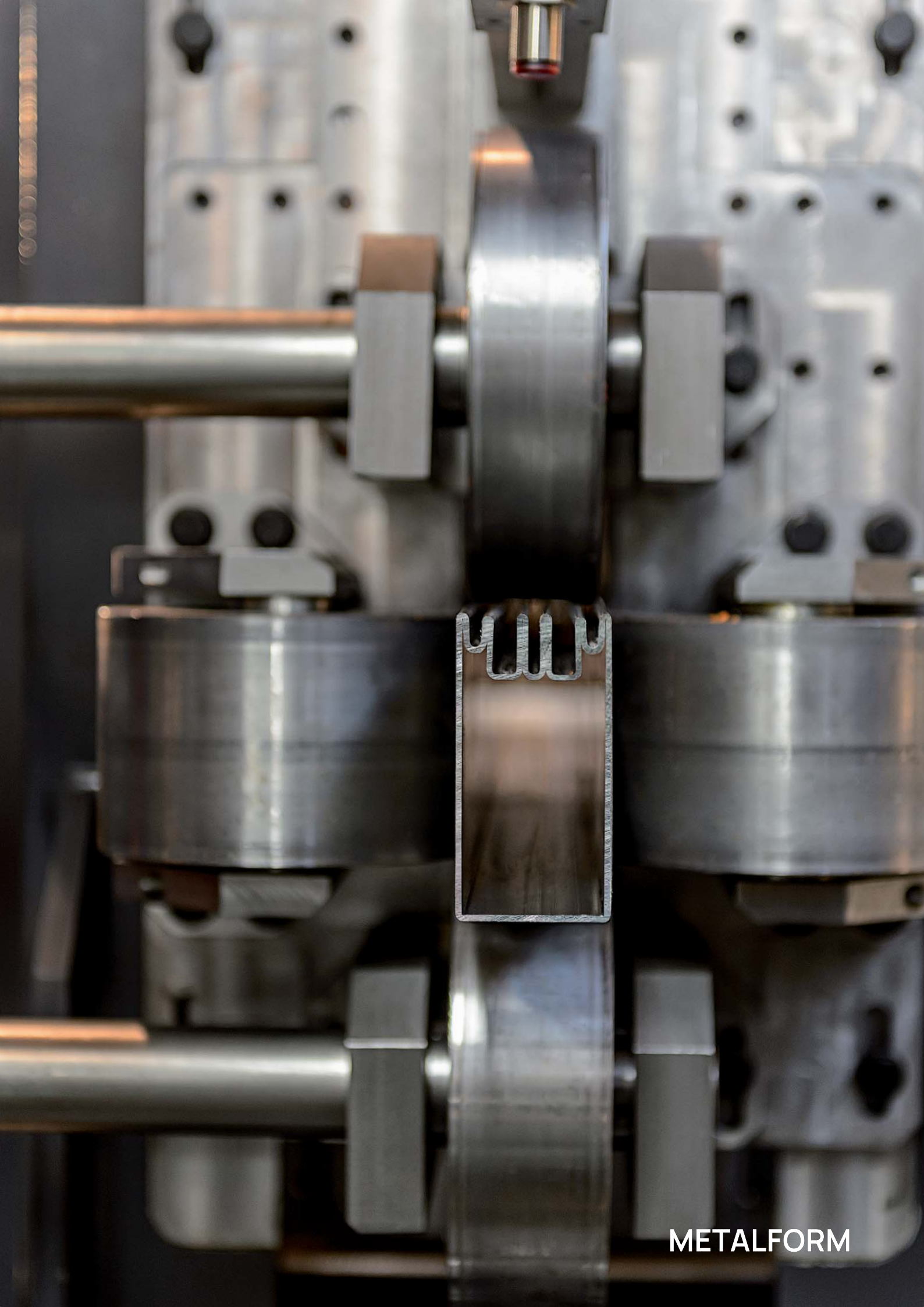

METALFORM

materials value

**the quality and
diversity of
materials confirm
secco sistemi
exclusivity
providing great
versatility for
every solution**

The use of a wide range of high-quality materials bears testament to Secco Sistemi commitment to provide architectural solutions with high aesthetic and technical-performance values. The constant search for alloys that meet the ever demanding needs for versatility and sustainability of contemporary projects leads the company to suggest the use of structures in stainless steel, galvanised steel and Corten steel also for curtain walls, since these materials ensure optimal strength and long life, with reduced maintenance needs. The wide range of materials, also available with scotch brite, satin and polished finishing, is further extended with the introduction of brass cladding profiles with burnished or polished finishing, specifically dedicated to the realisation of particularly exclusive environments.

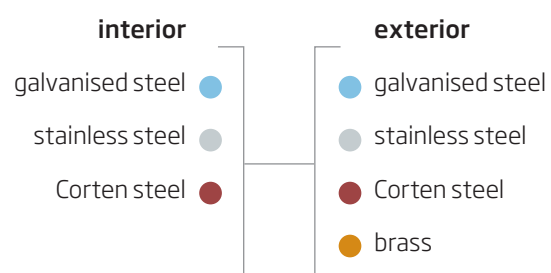

galvanised steel

the wide
chromatic range
offers a specific
solution to meet
every project
need

Profiles with very small sections, obtained thanks to the physical and technical features of steel, allow for the development of solutions with a reduced visual impact that ensure increased indoor brightness.

The steel used by Secco Sistemi for the manufacturing of its profiles is FeP02, a special alloy treated with an innovative metal coating on the entire surface obtained by dipping the steel in a molten magnesium bath that increases the effectiveness of the corrosion protection, thus providing greater stability and resistance, and ensures higher performance levels than any other galvanised steel. Said manufacturing process, conceived by measuring and reducing the use of zinc, bears testament to Secco Sistemi commitment towards environmental sustainability. The subsequent skin-passing process of the zinc layer delivers an optimal paint grip thanks to polyester powder coatings cured in an oven at 180°, available in a wide range of colours in polished, semi-polished, matte and sablè finishing.

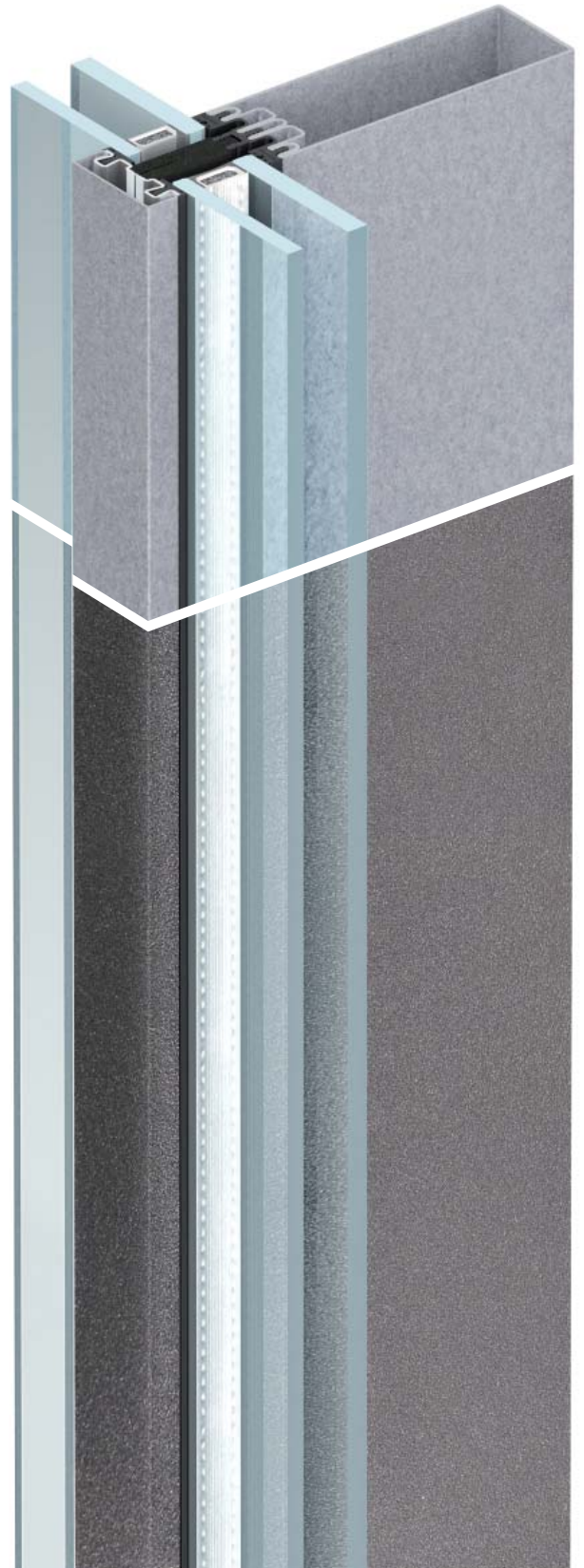

corten steel

the high visual value turns finished doors and windows into unique and exclusive products

Corten steel is a high-resistance self-passivating alloy containing copper, chrome and phosphorus, characterised by a high resistance to corrosion (*cor-rosion*) and to tensile yield (*ten-sil*).

These alloys are self-protective thanks to the formation of a superficial layer that prevents the corrosion process to gradually extend, while giving the product unique chromatic features the shades of which recall the passing of time.

The 4F curtain wall by Secco Sistemi, besides the thick profiles in Corten steel for mullions, transoms and external covers, includes all the hardware made in a material compatible with this finishing, mainly stainless steel. Moreover, Secco Lab developed, tested and fine-tuned an oxidation process for Corten steel that makes it possible to achieve the finishing and desired effect in just a few weeks, in controlled and replicable conditions.



stainless steel

the inalterability of the surface makes this material ideal for use in harsh environments

Secco Sistemi employs two types of stainless steel: AISI 304, more commonly used and available in a satin finishing and AISI 316L available in Scotch Brite or polished finishing, particularly suitable for marine environments. Their physical and mechanical features allow for the realisation of profiles with small sections, and ensure unlimited life and low maintenance. The low thermal conductivity makes this material particularly suitable for the realisation of thermal break elements with a low transmittance value. Robust and resistant to corrosion, stainless steel is hygienic and able to ensure full compliance with sustainability standards throughout its life cycle, thanks to its level of recyclability - up to 90% - and the possibility to re-use nickel and chrome not degraded during the recovery process.



brass

the high resistance
to corrosion
perfectly combines
with the high value
of bronze

Secco Sistemi brass profiles are manufactured using the OT67 alloy in which the high percentage of copper (67%) determines the high resistance to corrosion, while the remaining percentage of zinc (33%) improves its mechanical properties, such as hardness and tensile strength. Brass has the ability to naturally oxidise when in contact with air, thus acquiring a variety of colour nuances that make the finished product unique. It is indeed an example of excellence in terms of sustainability throughout its life cycle, since it allows for a 100% reuse of production scraps, thus obtaining new products at just their processing cost, ensures reduced energy consumption for reuse, thanks to high-efficiency technologies, and guarantees environmental compatibility with full reuse of by-products from the recovery cycle. Brass is only available for external covers.





METALFORM

detail value

**the design
of industrial
components
determines the
aesthetic quality
and perfect
functioning
of the system**

The meticulous attention to details makes the integrated facade, door and window system by Secco Sistemi the perfect solution for the most demanding needs of contemporary projects. With thin profiles, invisible assembling, gaskets and hardware - carefully designed in the most appropriate dimensions for an easy assembly, installation and maintenance -, the clean lines and efficiency of the building combine with the excellent technological performance of doors and windows. The industrial process followed to obtain each and every component of the system, while ensuring full quality control, optimises and enhances the features of the architectural project.



detail value

façade

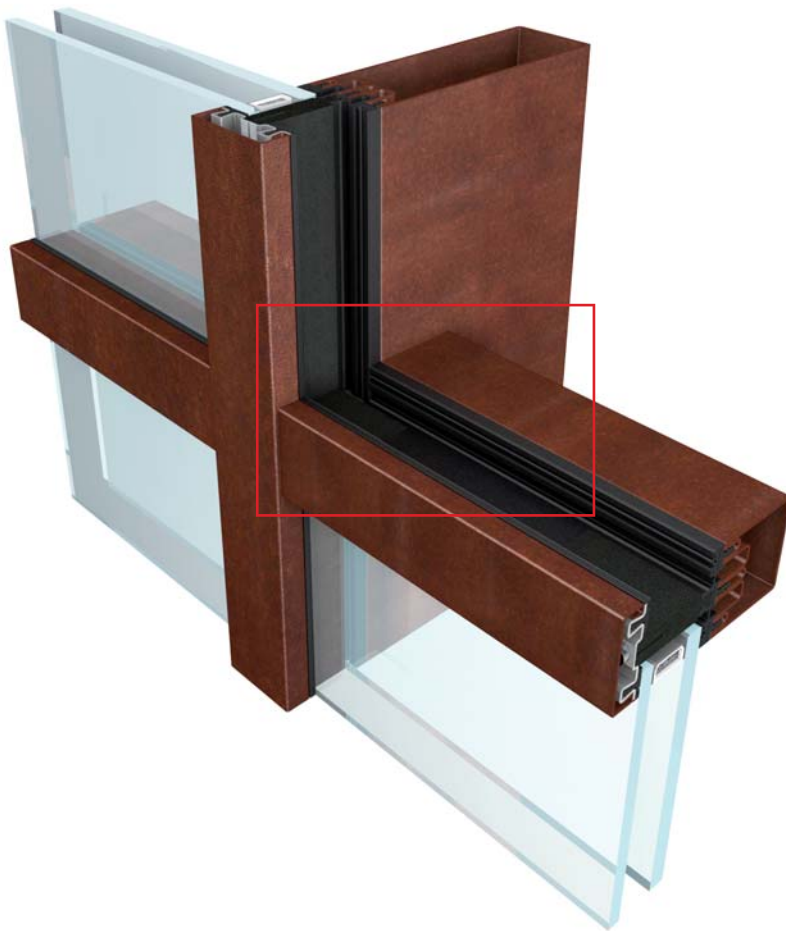

Designed and developed with the utmost care for details, Secco Sistemi curtain walls combine the search for clean lines with the development of new technological solutions, ensuring the perfect match between accurate design and living comfort.

detail

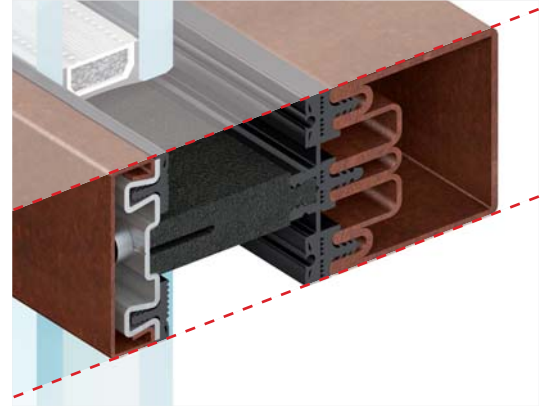

gasket

Minimising the visual impact of individual components on the façade, all internal and external perimeter gaskets have been designed to ensure superior environmental performance and easy installation, as well as to offer the most suitable solutions for contemporary architecture. Their perfect alignment with the size of the profiles makes the gasket virtually "invisible", only leaving in sight the steel of the load bearing structures and the glass of large window panels.

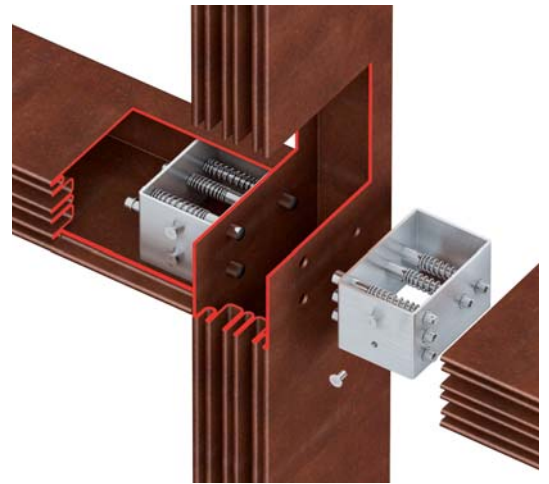

bottom plate

The connection between the load bearing profiles, primary structural node of the system, is also "hidden" from view thanks to the integration of a technical component that fits inside the transom and is clipped on the mullion. This results in a façade that keeps the material of profiles, mullions and transoms, seamless and completely free of interposed elements. Moreover, this component, through a system of spring-loaded pins, makes it possible to remove the coupling device without damaging any elements of the structure.

disassembled facade

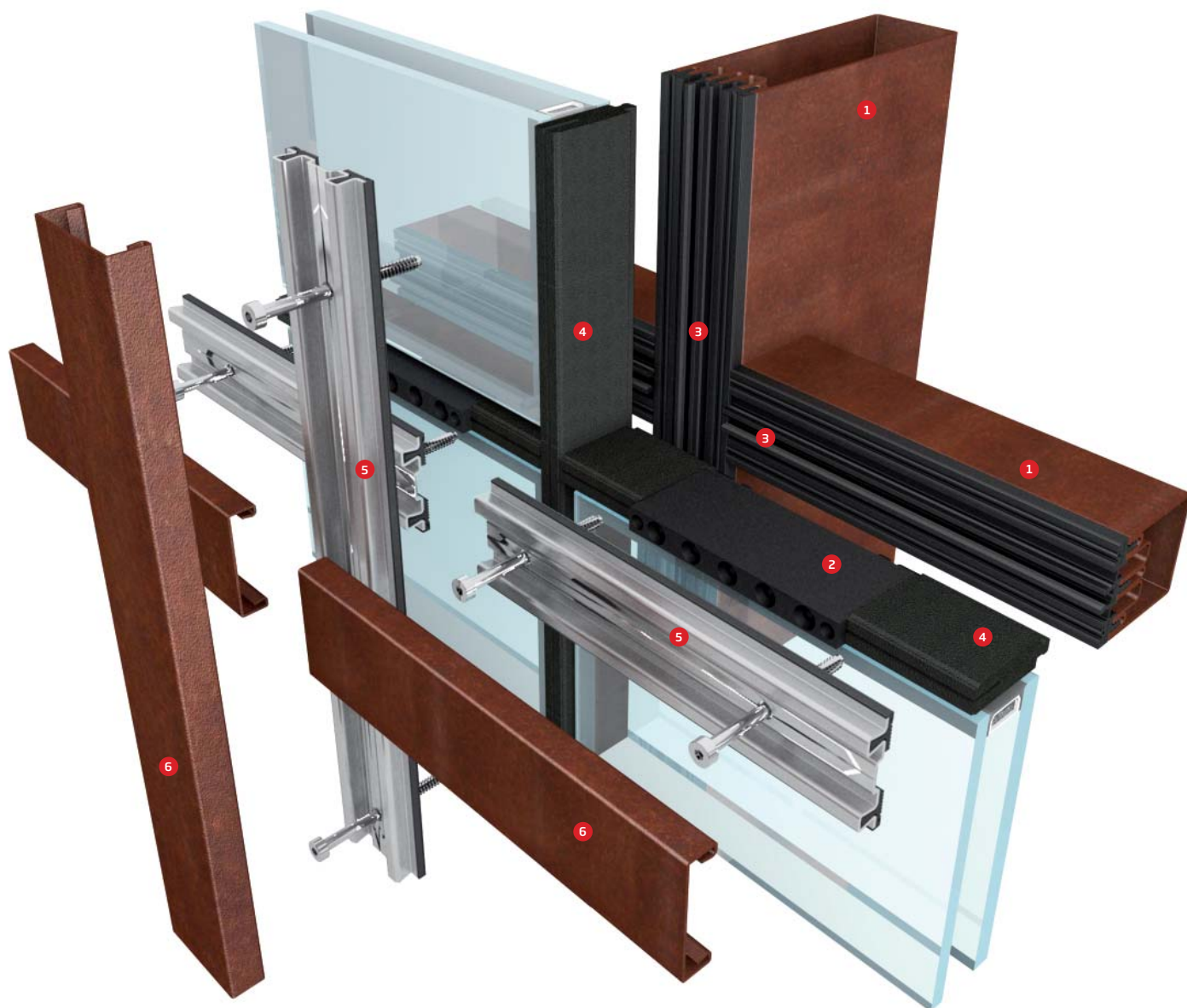

- ① mullion/transom profiles in 5 finishes
- ② variable support for glazing up to 56 mm
- ③ sealing and water draining gaskets system
- ④ extruded polyethylene foam for greater technical performance
- ⑤ pre-drilled hold-down device for easy installation
- ⑥ cover profile in 7 finishes



METALFORM



METALFORM





METALFORM

fire value

technical and design solutions result in a certified fire-resistant facade

In the design of fire-resistant facades, Secco Sistemi uses the same aesthetic and functional solutions adopted in all of its products. The system is designed with a view to maintain the architectural concept of the final product internally and externally both in terms of materials and details. To this end, integrity only partitions and fully insulated systems are available that can, using different profile sizes, frame materials, glazing types, and different hardware, be suitable for every project design solution. The system is capable of achieving fire resistance from 30 minutes (E30) to 90 minutes (EI90). These performance levels have been tested in the best European certifying laboratories.

E30, EW60, EI30, EI60, EI90

	sealing capability of the door frame to contain fire, fumes and flammable gases
	irradiation capability of the door frame to contain the irradiation to one metre on the non-exposed side
	insulation capability of the door frame to contain the temperature on the non-exposed side

fire value

requirements



Fire-resistant elements and components have been specifically designed to meet the requirements of structural resistance and internal temperatures of 1000° C, retention of external surface temperatures below 180° C, absence of hot flammable fumes, dimension and weight of glasses that can reach huge proportions, duration of performance levels up to 90 minutes.

To this end, the physical and mechanical properties of 4F structural profiles are maximized thus allowing for the use of structural profiles with sections and depths much smaller than any other material. By simply integrating specific internal intumescent components, 4F becomes a fire resistant system which makes it possible to introduce glazing, solid panels, and openings realised with the same materials used for the facade profiles. Everything without any width or height restrictions.

exterior - profile surface

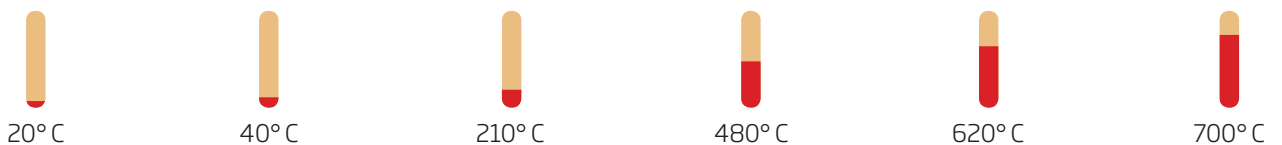
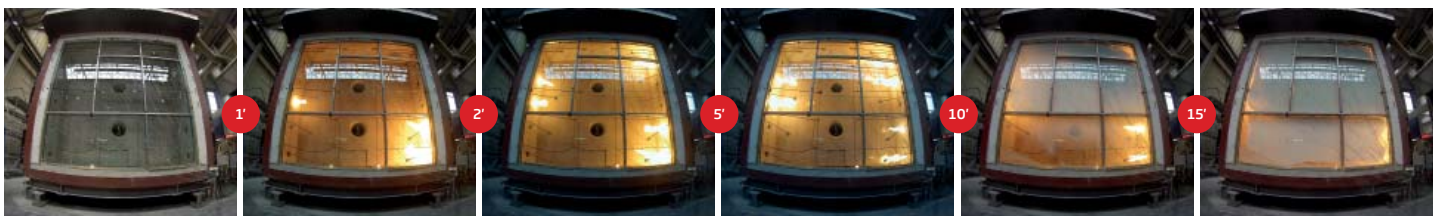

interior - furnace combustion chamber

detail

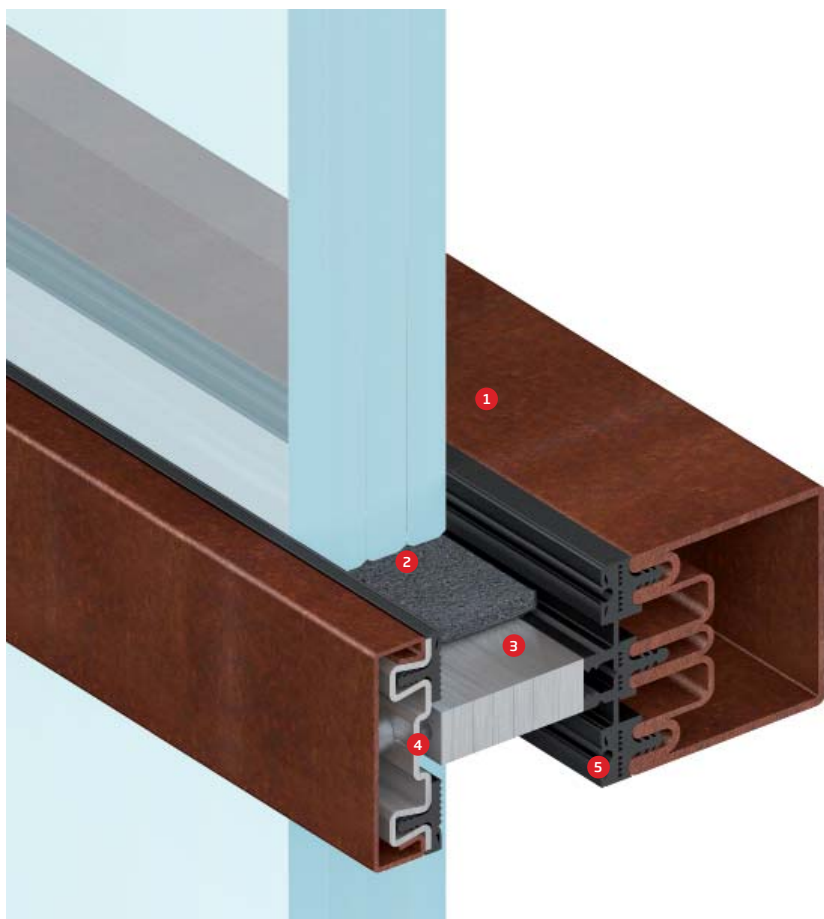

- 1 galvanised steel, stainless steel, Corten steel structural profile
- 2 intumescent gasket
- 3 glass support in stainless steel
- 4 hold-down device in galvanised steel, stainless steel
- 5 airtight and water draining gasket

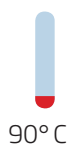
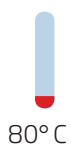



METALFORM

certification and performance value

**innovative
solutions,
developed and
tested in the
factory, involve
individual
components as
well as the entire
building process**

Secco Sistemi reinstated its commitment to product development and innovation by setting up Secco Lab, the in-house company lab dedicated to research, testing, prototyping, inspection, and certification activities.

Thanks to their consolidated expertise in the properties of materials and production technologies, as well as to a thorough knowledge of applicable regulations and non-binding standards in force in the destination markets, the lab personnel test high-performance solutions, firstly on individual components, then on real samples, simulating the most severe stress conditions a product is subject to during its life cycle. These inspections focus on environmental comfort, duration, stress and ageing, as well as on the entire building method, to ensure the overall quality and certify the final result.



wind resistance
± 2,0 | ± 3,0 kN/m²



water tightness
RE 1500 | 250 Pa/750 Pa



thermal transmittance
up to 0.80 W/m²K



air permeability
AE



impact resistance
I5 / E5



METALFORM



METALFORM

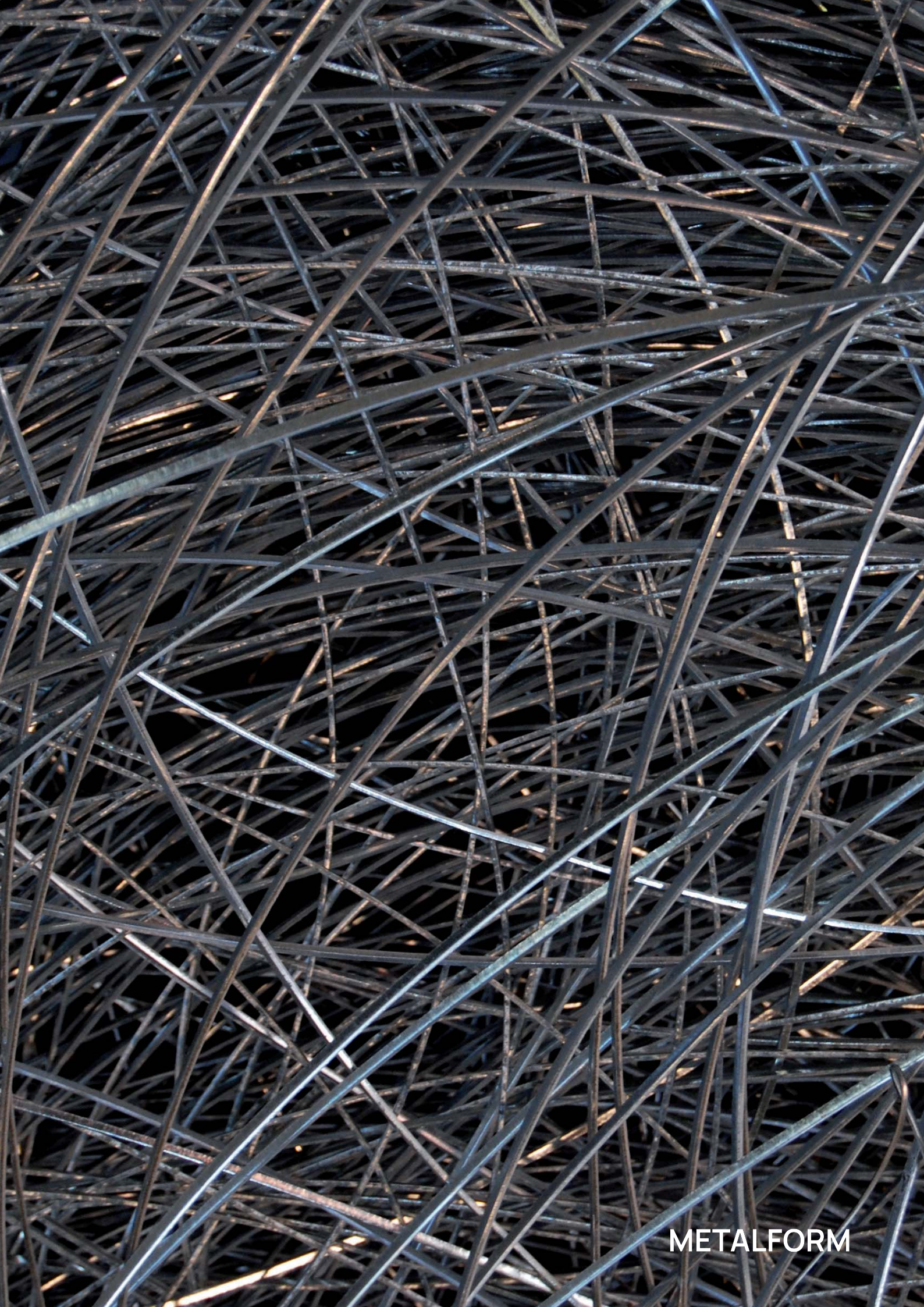

METALFORM

sustainability value

conscious and sustainable practices characterise strategies and solutions for products and processes

In each and every one of its corporate choices, Secco Sistemi aims to promote the increase of environmental, economic and social benefits, contributing to the preservation of collective resources.

In addition to the use of materials such as steel and glass, which are by nature environment-friendly since they can be recycled and reused, last long and require minimum maintenance in their end-use, attention is given to the control of every step of the designing and manufacturing process, with a view to ensuring maximum energy efficiency, superior living comfort and reduced environmental impact, in compliance with current regulations. The use of high-performance glazing and the accurate design of details contribute to a further reduction of the building energy consumption, while minimising management and dismantling costs.

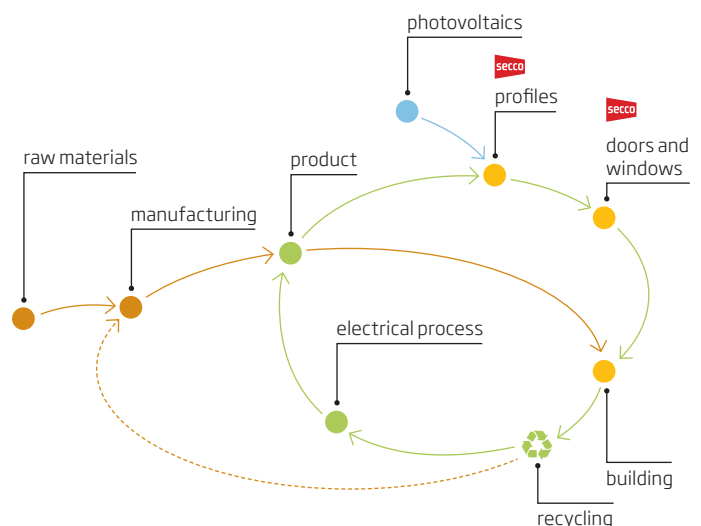



METALFORM

Aldo Rossi, BBPR, Carlo Mollino, Gio Ponti,
Carlo Scarpa, Gino Valle, Giovanni Muzio,
Giancarlo De Carlo, Marco Zanuso,
Giovanni Michelucci, Ignazio Gardella,
Lucio Passarelli, Melchiorre Bega,
Nizzoli Associati, Pier Luigi Nervi,
Pierluigi Spadolini, Tommaso Valle,
Vico Magistretti, Vittoriano Viganò...

**Secco Sistemi has worked with
the masters of Italian architecture
and continues to co-operate with
the most qualified contemporary
architects in search for innovation
and sustainable quality.**



METALFORM

4F 1

the solution for steel
facade with smaller
sections in line
with architectural
research and aesthetic
innovation

Modern design requires minimum visible front sections in order to “build” with light, increasing its influence and effect. Bigger openings require bigger inertia and, therefore, mullions with bigger sections.

4F 1 meets these new design requirements for metal facades with different versions of its products. **4F 1** provides mullions in steel, stainless steel and Corten steel with a high moment of inertia, thus ensuring the attainment of the required static values without compromising the aesthetic quality of the materials.

The external covers, with a reduced size of 50 mm and available in steel, stainless steel, Corten steel and burnished brass, allow for the integration of the facade into any architectural context. **4F 1** has been tested to guarantee the highest performance even with opening doors and windows.



area of application

- curtain walls with mullions and transoms

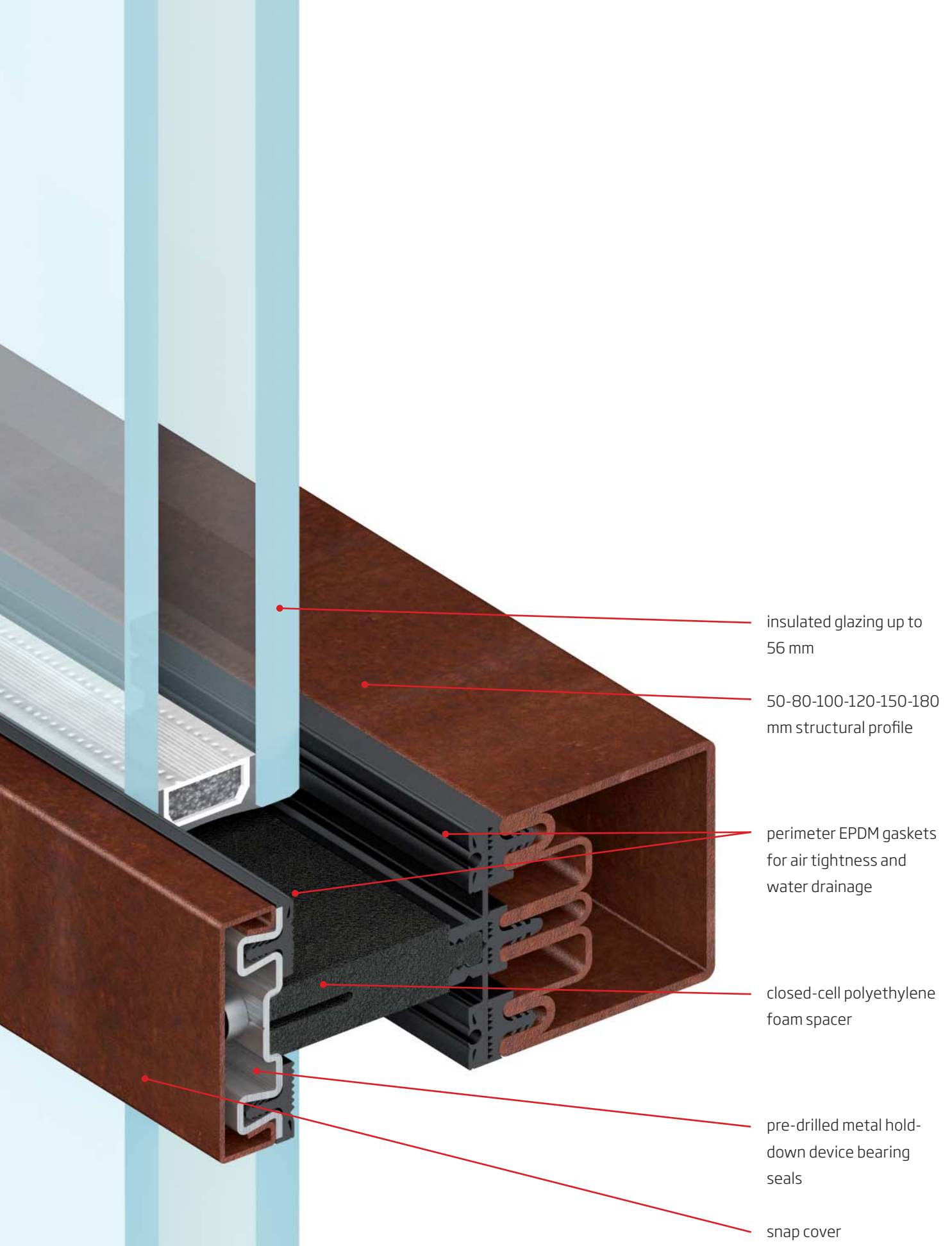

insulated glazing up to 56 mm

50-80-100-120-150-180 mm structural profile

perimeter EPDM gaskets for air tightness and water drainage

closed-cell polyethylene foam spacer

pre-drilled metal hold-down device bearing seals

snap cover

Corten steel version

4F 1

Provincial Administration Headquarters | Treviso



The new Provincial Administration Headquarters located in Treviso, is the result of an extensive renovation and restoration project carried out on the premises of the former neuropsychiatric hospital in S. Artemio, dismantled in 1978. It consists of fifteen pre-existing buildings connected by catwalks that accommodate all the offices of the provincial administration that

have been grouped and reorganised. Surrounded by a vast green area, in a setting with a very high environmental quality just outside the city, this building complex is characterized by curtain walls with wide glass panels that strengthen its identity by opening the complex towards the monumental park, while creating spatial continuity between pre-existing and new spaces.

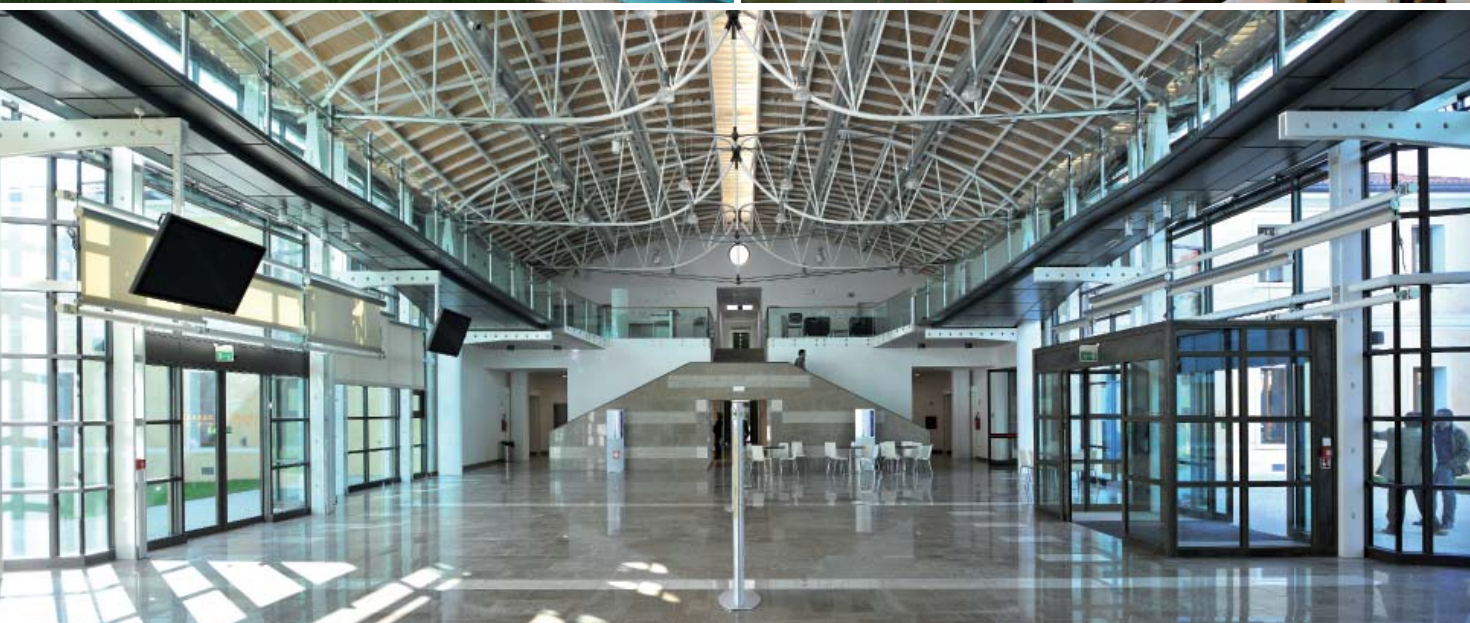

With a view to ensuring the best possible use of materials according to their destination, Secco Sistemi decided to install 4F1 curtain walls with an internal structure in galvanised steel and external covers in burnished brass, so as to improve weather resistance. In addition to its significant architectural impact, this solution allows for the integration of windows and doors of

the EBE 65 range, as well as the installation of high-performance glass, thus ensuring superior comfort even in large spaces.

4F 1

system and performance

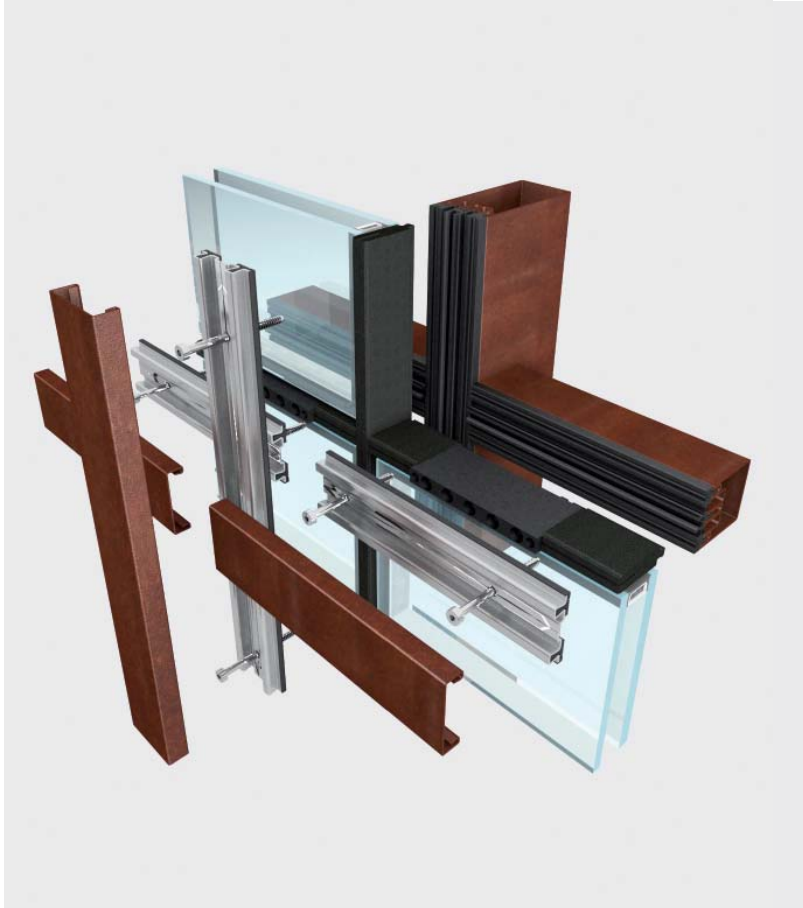

4F 1 is a system designed for thermal break curtain walls, and for mullions and transoms with structural sections from 50 mm to 180 mm deep and 50 mm wide. The high elasticity of metal guarantees a solid yet light and slender structure. Air and water tightness are ensured by a system of EPDM gaskets equipped with drain devices for potential seepage. The glass, up to 56 mm, is fitted frontally and placed on specific supports secured to the structural profiles, and fixed to mullions and transoms by a hold-down device bearing seals pre-drilled for screws application. The performance levels of the **4F 1** system have been tested by the best European certifying labs in compliance with the reference standards EN 13830. The **4F 1** mullion/transom can be 50, 80, 100, 120, 150, 180 mm thick. The size of internal profiles and external covers is 50 mm; the depth of the cover is 16 mm for the mullions and 13 mm for the transoms.

wind resistance - allowed load	$\pm 2,0 \text{ kN/m}^2$
wind resistance - increased load	$\pm 3,0 \text{ kN/m}^2$
impact resistance	I5 / E5
water tightness - static	RE 1500
water tightness - dynamic	250 Pa/750 Pa
thermal transmittance	0,80 W/m ² K
air permeability	AE

under reference standard EN 13830

size and variations

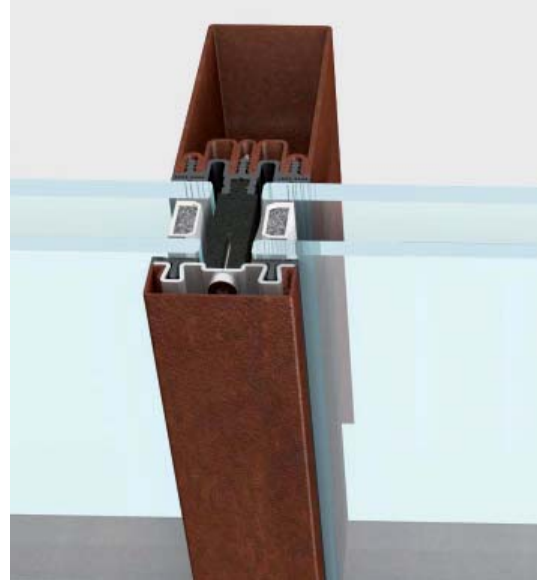

transom/mullion 100mm deep | 50 mm face section



transom/mullion 50 mm deep | 50 mm face section

The **4F 1** transom/mullion can be 50 mm or 100 mm thick. The size of the internal profiles and external covers is 50 mm; the depth of the cover is 16 mm for the mullions and 13 mm for the transoms.

material for transom and mullions



galvanized steel



stainless steel

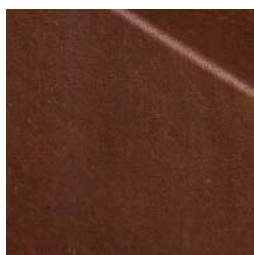

corten steel

4F1 structural profiles are available in galvanized steel - in a wide range of colours and superficial finishes - in brushed AISI 304 steel, in polished or Scotch Brite AISI316L stainless steel and corten steel.

material for covers



galvanized steel



stainless steel

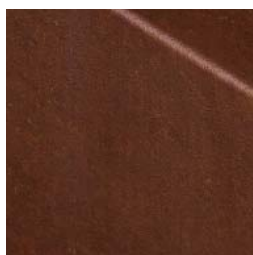

corten steel

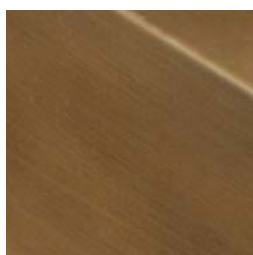

brass

4F1 covers are available in galvanized steel - in a wide range of colours and superficial finishes - in AISI 304 brushed stainless steel, in AISI 316L polished or Scotch-Brite stainless steel, corten steel and in brass (OT67 copper alloy).

application options



transom 100 mm | mullion 50 mm



transom 100 mm | mullion 100 mm

4F1 is equipped with concealed bottom plates in stainless steel to head join mullions to transoms in all the different combinations.

main type

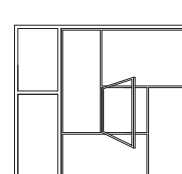
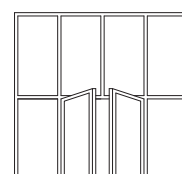
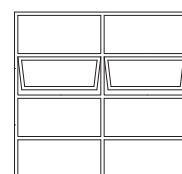
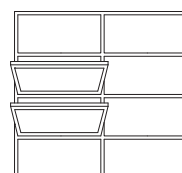
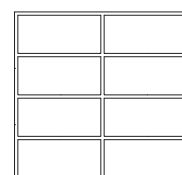
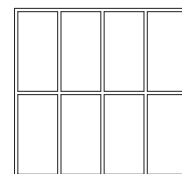

Custom solutions are available in co-operation with Secco Sistemi technical office.

4F1 allows for the integration of all EBE 65, EBE 85 and OS2 systems.

4F 1

Cruise terminal | Venice



With the new terminal "Isonzo 2" Venice now features a primary cruise hub and becomes the point of departure of some of the most charming itineraries along the Mediterranean routes, such as Italy, Croatia, Greece and Turkey. The need to minimise the environmental impact and ensure the safe and well organised disembarkation of passengers, was at the

core of the main project guidelines. The building has therefore been designed according to criteria of maximum space rationalisation, distributing the over 14.000 sqm on two different levels with a roof terrace. In order to ensure perceptual continuity and the fluidity between interior and exterior, Secco Sistemi chose the

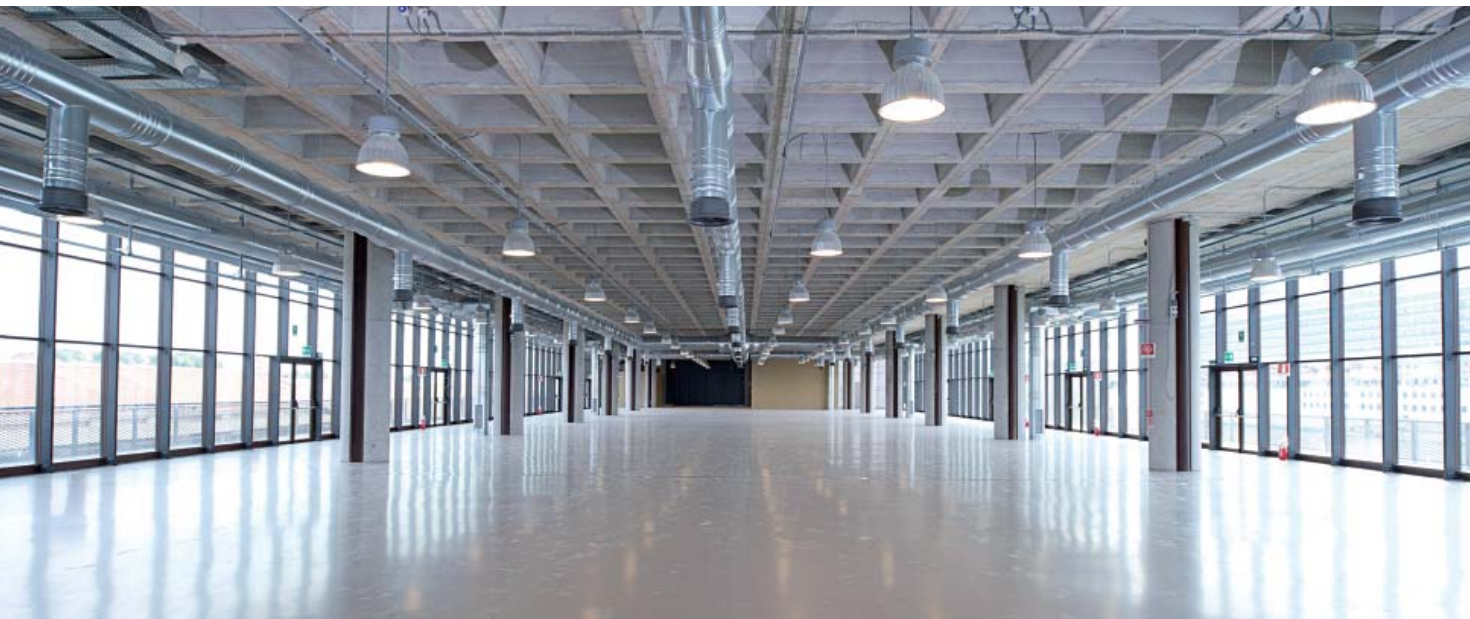

4F 1 curtain wall with Corten steel mullions and transoms, that integrates EBE thermal break door and window frames used for entrances and emergency exits. The use of properly treated Corten steel provides interesting colour variations, creating a highly natural effect that is crucial to ensure the smooth integration of the building in the fragile lagoon environment.

4F 2

the add-on curtain wall system for modern grand scale architecture

The large curtain wall, with customised load bearing elements (transoms and mullions), have become an emblem and a symbol of the city life. They give the building a distinguished and unmistakable look and are a good representation of the designer's architectural creativity.

4F 2 add-on curtain wall system gives a unique taste to the structure where it's applied thanks to the possibility of using and combining, both on the interior and exterior, different materials such as steel, stainless steel, corten, brass and wood.

The use of mullions and transoms, with big inertia and sections, makes it possible to build large and bright glazed areas, thus leaving the designer free to design the structure and fronts to taste.

4F 2, with its complete range of profiles and gaskets, offers customised solutions for the use of high performance glazing in any size and thickness. The covers, made of steel, stainless steel, corten, brass and burnished brass and with a reduced size of 50 mm, give elegance and lightness to the facade while leaving space for glazing and brightness.



area of application

- curtain wall with load bearing sub-structure in different materials

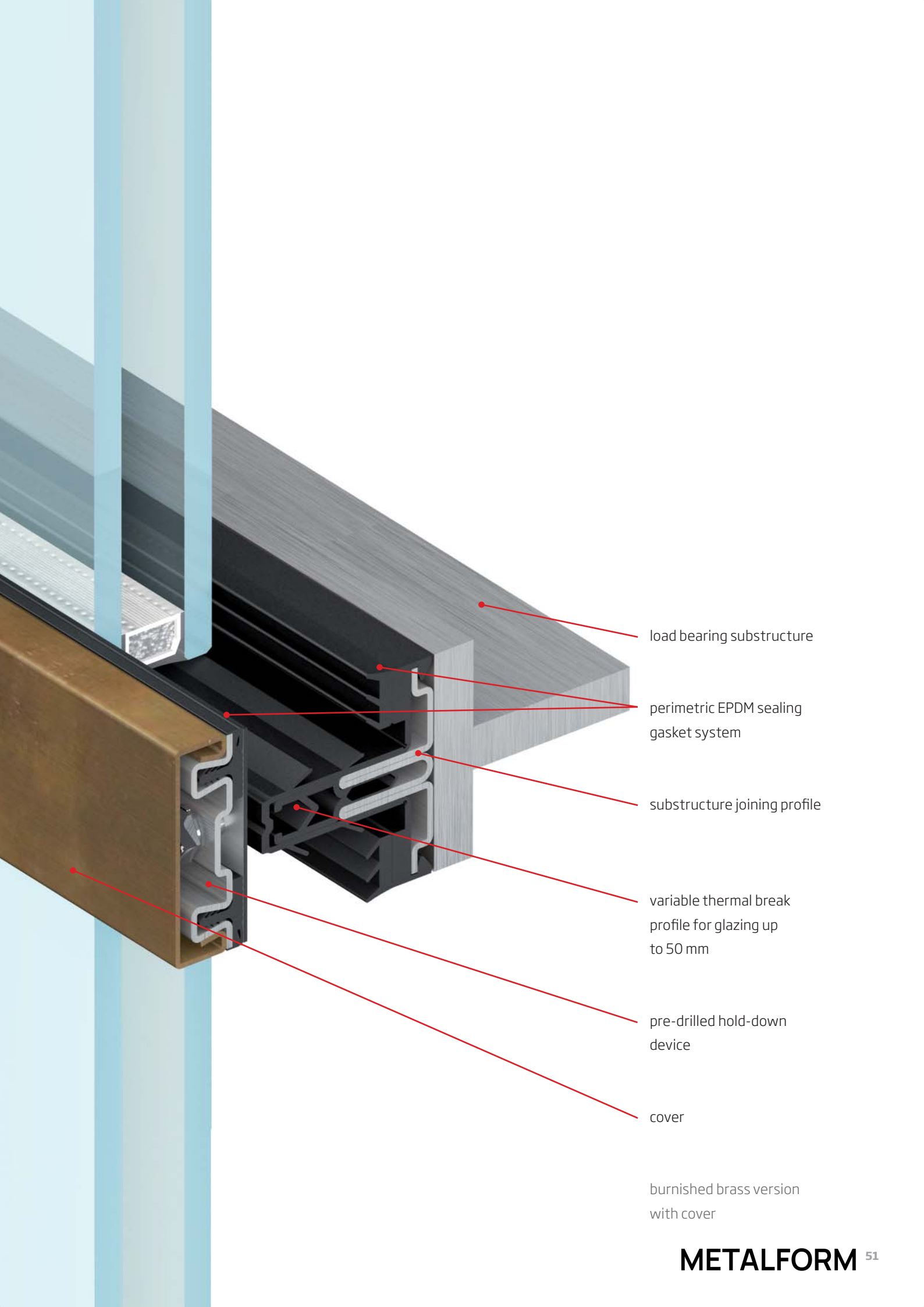

load bearing substructure

perimetric EPDM sealing gasket system

substructure joining profile

variable thermal break profile for glazing up to 50 mm

pre-drilled hold-down device

cover

burnished brass version with cover

4F 2

BMW-Mini dealer | Isola delle Femmine (PA)



The contemporary architectural values of transparency, technological innovation and aesthetic research that underpin the design of the new BMW-Mini dealer of Isola delle Femmine, in the province of Palermo, are perfectly in line with the qualities that well represent this prestigious international brand.

Combining functionality and brand enhancement, the designers chose to focus on cutting-edge solutions both in terms of materials and building systems. The new technical-commercial centre consists of three industrial sheds that cover an area of approximately 12.000 sqm

and is realised with a mixed structure of prefabricated reinforced concrete panels and steel pillars delimited by wide glass panels, especially in the buildings that house showrooms and the Management offices. In order to ensure the continuity between interior and exterior, a metal sub-structure has been



installed to support Secco Sistemi 4F 2 curtain wall with mullions and transoms in AISI 316L stainless steel. The modules of the glass window, in the first vertical order, have been cut to the maximum possible size for a glass plate. Sistemacciaio door and window frames made in AISI 316L stainless steel with a

Scotch Brite finishing are integrated into this solution to complete the building envelope.

4F 2

system and performance



4F 2 is a system designed for thermally broken add-on curtain walls, which can be secured with appropriate profiles and gaskets to each girder whether welded (the classic IPE, HEA in steel or stainless steel) or wooden, thus guaranteeing the same high performance. Water tightness is ensured by a system of EPDM gaskets and profiles equipped with drain devices for potential seepage. The high elasticity, typical of metal, guarantees a solid yet light and slender structure. The system is able to support glasses up to 50 mm of thickness, fitted frontally and fixed to the transoms and mullions by a hold-down device bearing gaskets. The performance of 4F 2 system has been tested by the best European certifying labs under the reference standards EN 13830.

wind resistance - allowed load	± 2,0 kN/m ²
wind resistance - increased load	± 3,0 kN/m ²
impact resistance	I5 / E5
water tightness - static	RE900
water tightness - dynamic	250 Pa/750 Pa
air permeability	AE

under reference standard EN 13830

size and variations

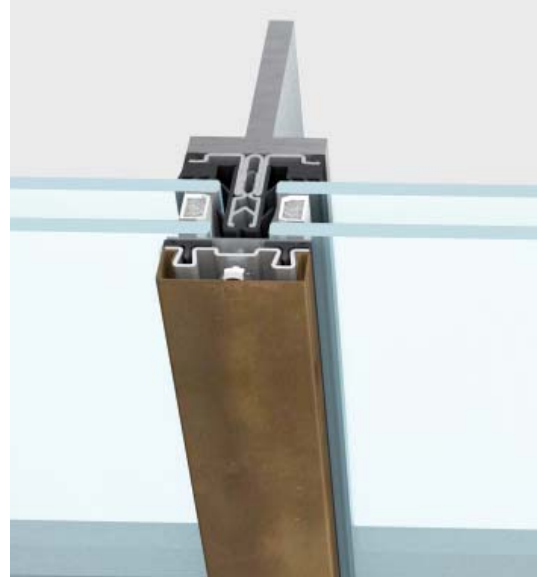

application to mullion | 50 mm face section



application to transom | 50 mm face section

The size of the internal profiles and external covers is 50 mm, the depth of the cover is 16 mm for the mullions and 13 mm for the transoms.

material for covers

application options

main type

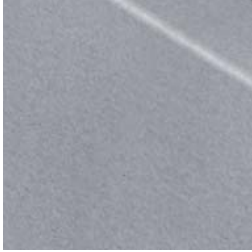

galvanized steel



stainless steel

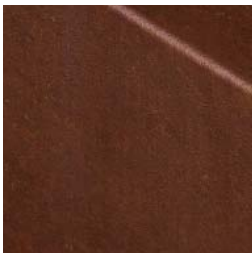

corten steel



brass

4F 2 covers are available in galvanized steel - in a wide range of colours and superficial finishes - in AISI 304 brushed stainless steel, in AISI 316L polished or Scotch-Brite stainless steel, corten steel and in brass (OT67 copper alloy).



IPE welded beam



rectangular pipe



customised welded girder



wooden girder

4F 2 can be fixed to any welded or customised girder.

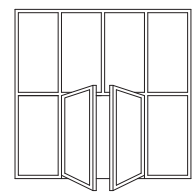
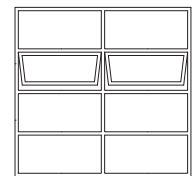
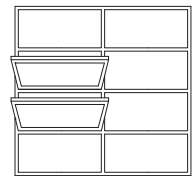
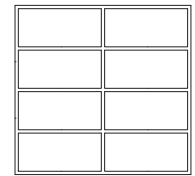
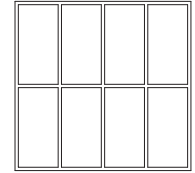

Custom solutions are available in co-operation with Secco Sistemi technical office.

4F 2

Caixanova headquarters | Pontevedra (E)



Caixanova, one of the leading Spanish financial institutions, devised the project of the new headquarters in Pontevedra, Galicia, as an opportunity to create common spaces for the community. Indeed, the building provides the citizens with a series of multi-function spaces, such as a large auditorium

for theatre and music performances with over 800 seats, conference halls and meeting rooms shared with the financial institution. The concept of "openness" becomes the key element of the architectural design that materialises in the 4F 2 curtain wall by Secco Sistemi, characterised by the contrast between wide



window panels and thin steel external covers. The use of the same material for door and window frames in the restored part, featuring a characteristic monumental architecture, as well as for internal and external doors, highlights the clean lines and at the same time the visual and material continuity of this imposing project.

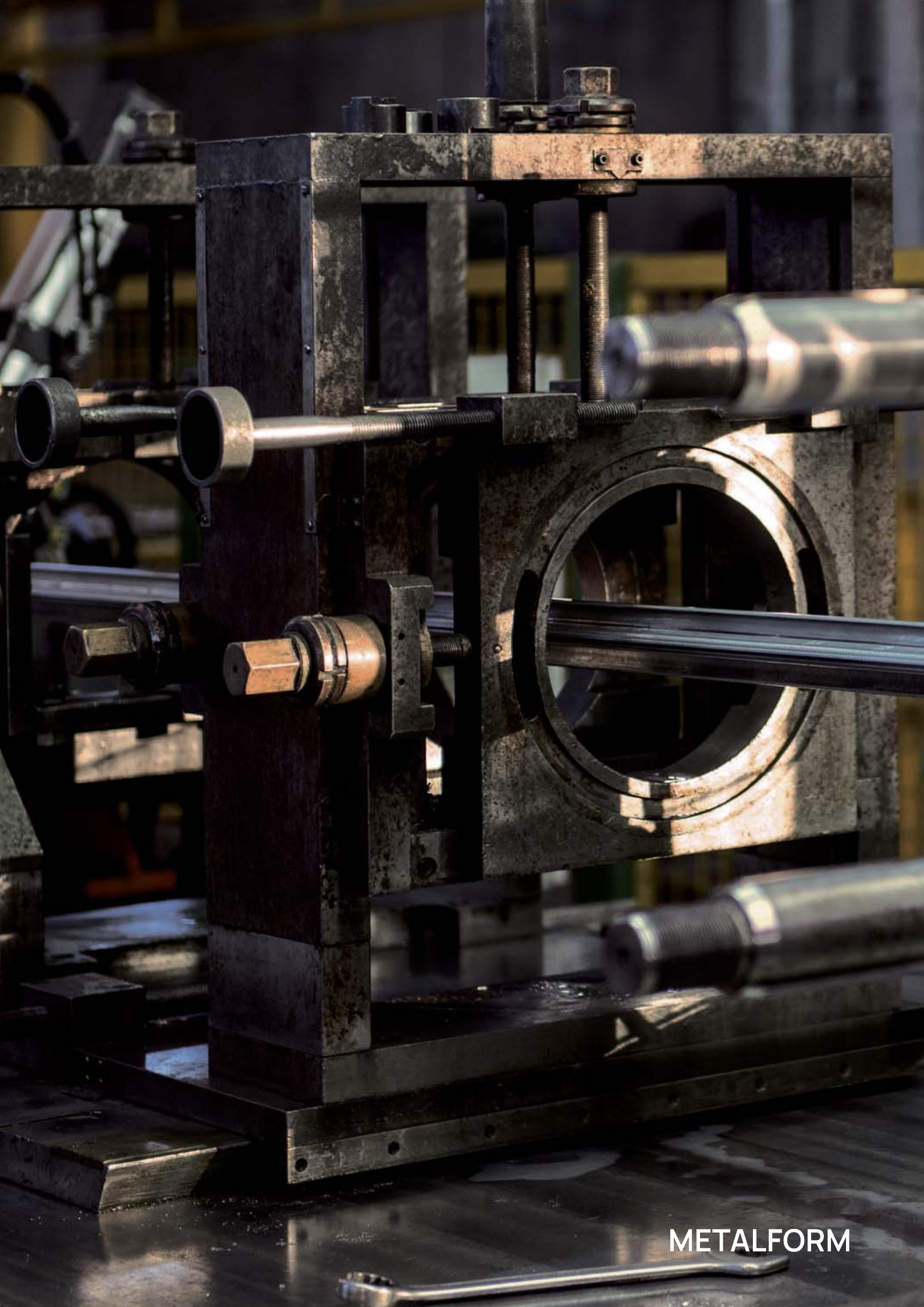

METALFORM



METALFORM

the reasons for this choice

a coordinated system able to provide flexibility to any architectural project, secco sistemi curtain wall is the result of a close multi-disciplinary collaboration between company and professionals

- combines superior technical and environmental performance with the high aesthetic values required by contemporary projects
- offers a wide range of materials and exclusive finishing providing customised solutions
- allows for the coordinated integration of facade, door and window leaving maximum freedom in the design of the building facade
- is flexible enough to be used for small and large projects in the most varied contexts
- ensures full quality control of the entire system thanks to the industrialisation of each and every detail
- stays true to environmentally conscious strategies throughout the project and manufacturing process
- is tested in the most demanding conditions and is subject to a rigorous certification procedure based on the transparency of data

4F 1

main sections

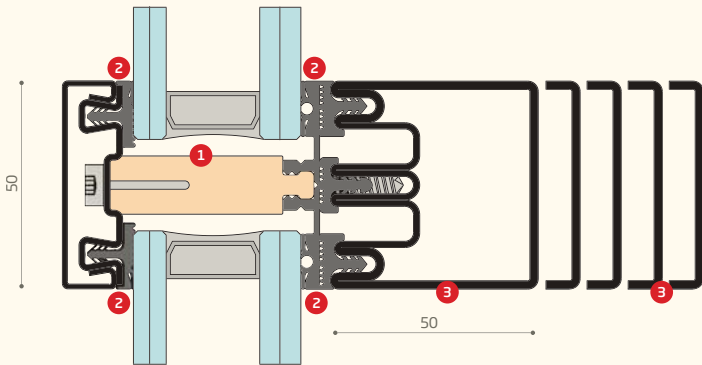

transom

1. variable thermal break profile for 25-56 mm glazing
2. transom water sealing gaskets
3. 50-180 mm structural profile

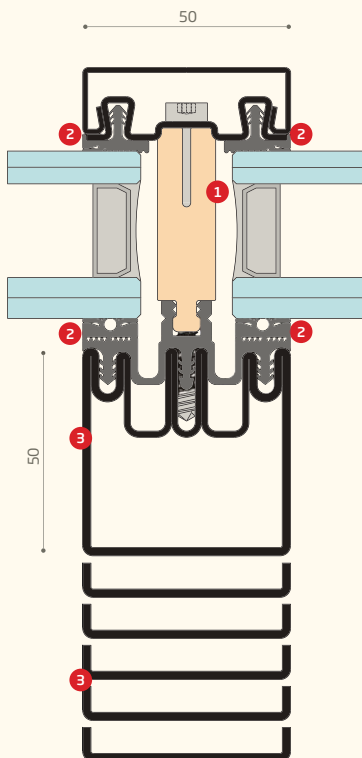

mullion

1. variable thermal break profile for 25-56 mm glazing
2. mullion sealing gaskets for water draining
3. 50-180 mm structural profile

profiles

P.3403

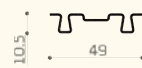

P.3406



P.3407

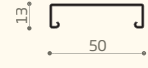

P.3605

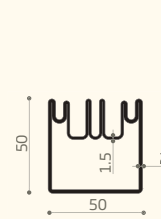

P.3608

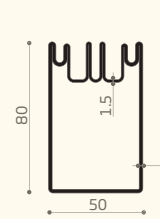

P.3610

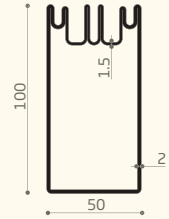

P.3612

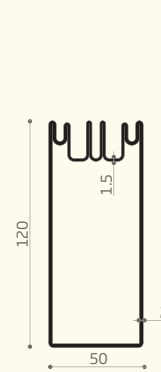

P.3615

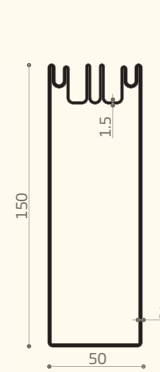

P.3618

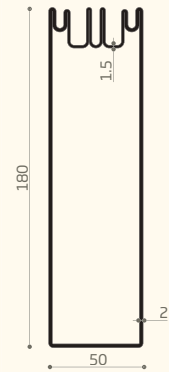

horizontal section

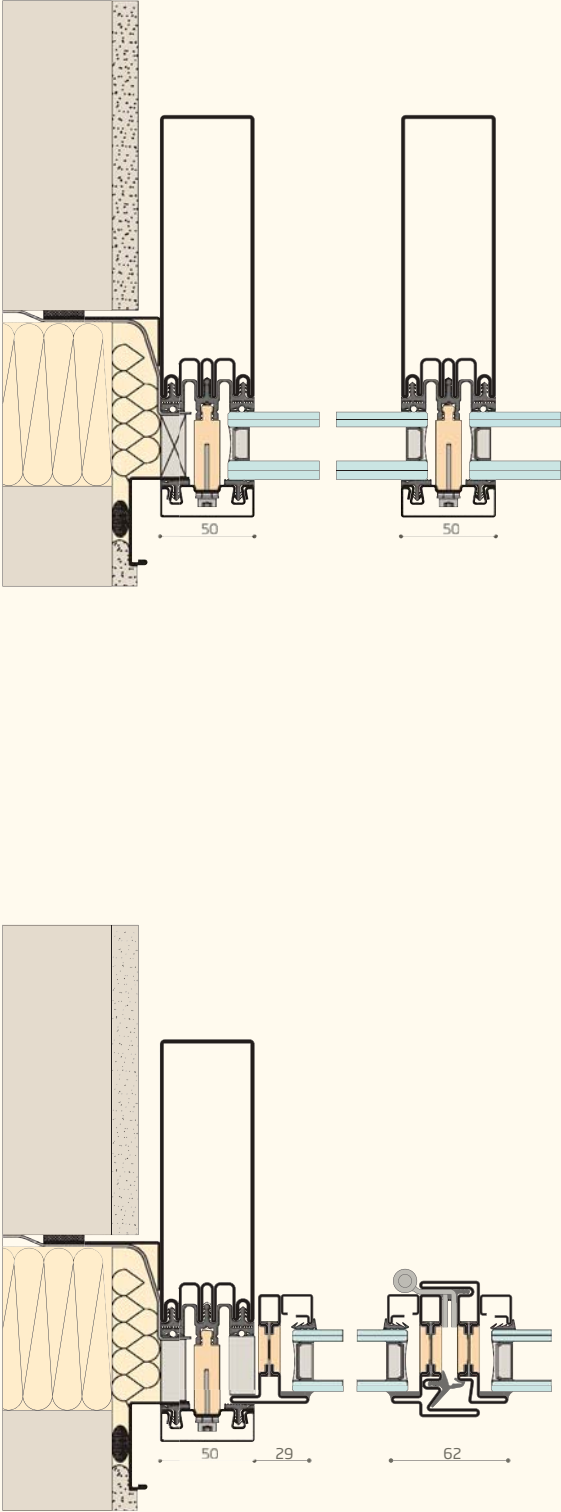

vertical section

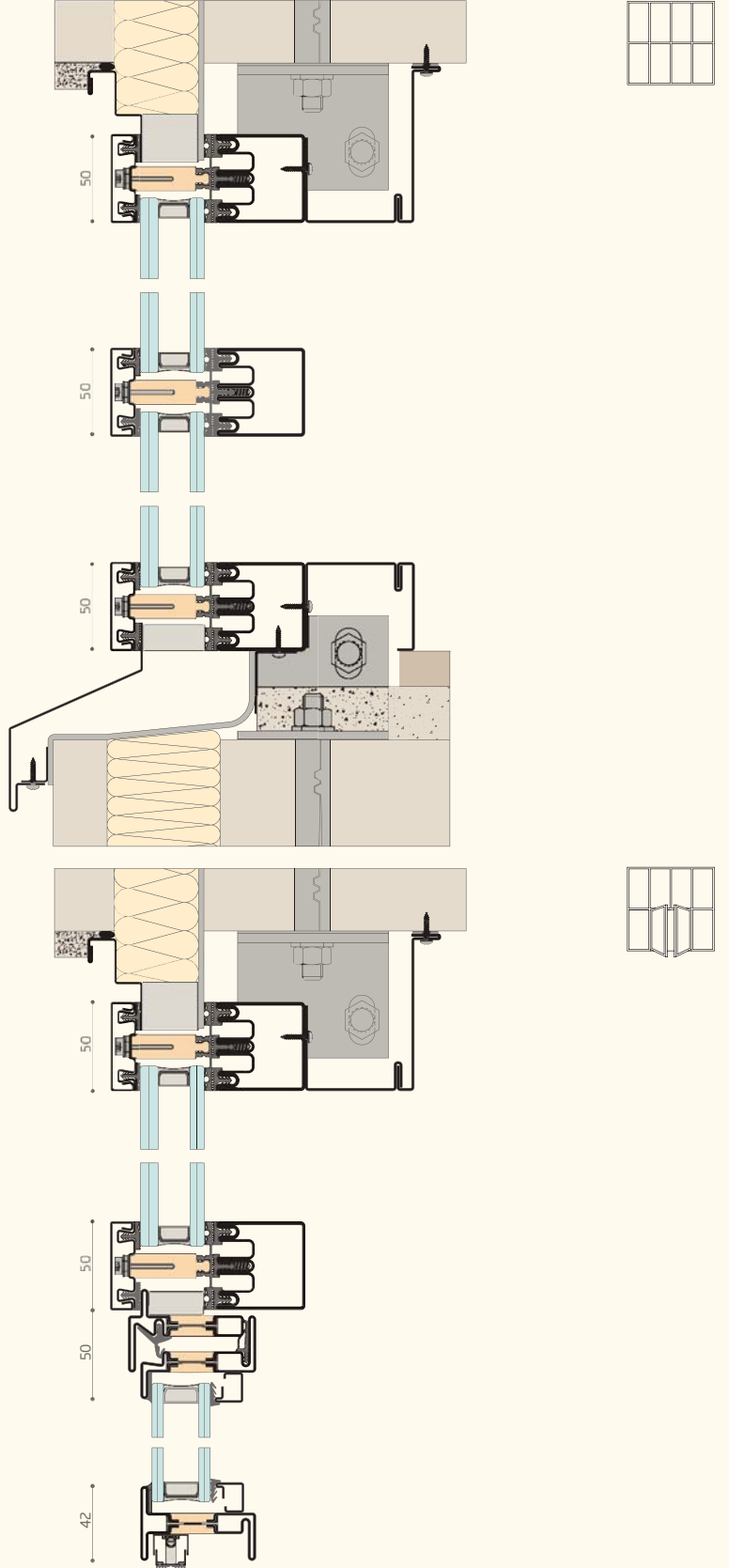

4F 2

main sections

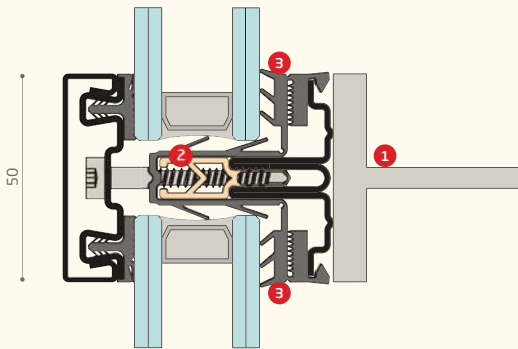

transom

1. support profile for screws or welding
2. variable thermal break profile for glazing up to 50 mm
3. transom water sealing gaskets

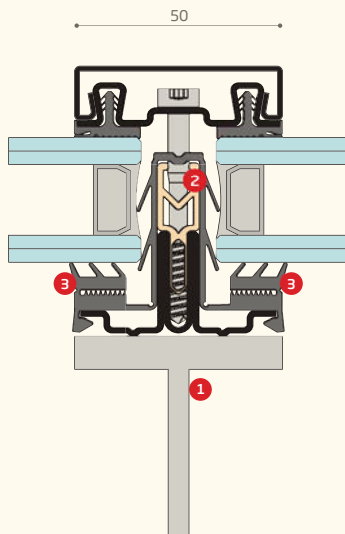

mullion

1. support profile for screws or welding
2. variable thermal break profile for glazing up to 50 mm
3. mullion sealing gaskets for water draining

profiles

P.3503

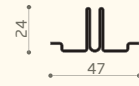

P.3403

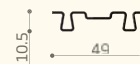

P.3406



P.3407



GU0304



horizontal section

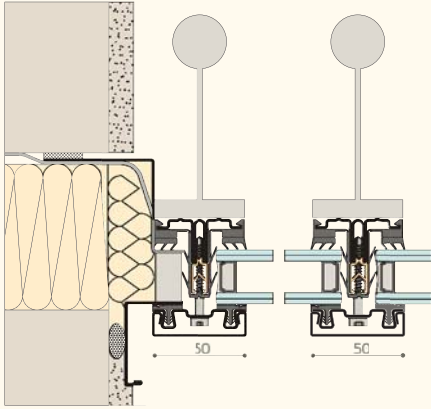

vertical section

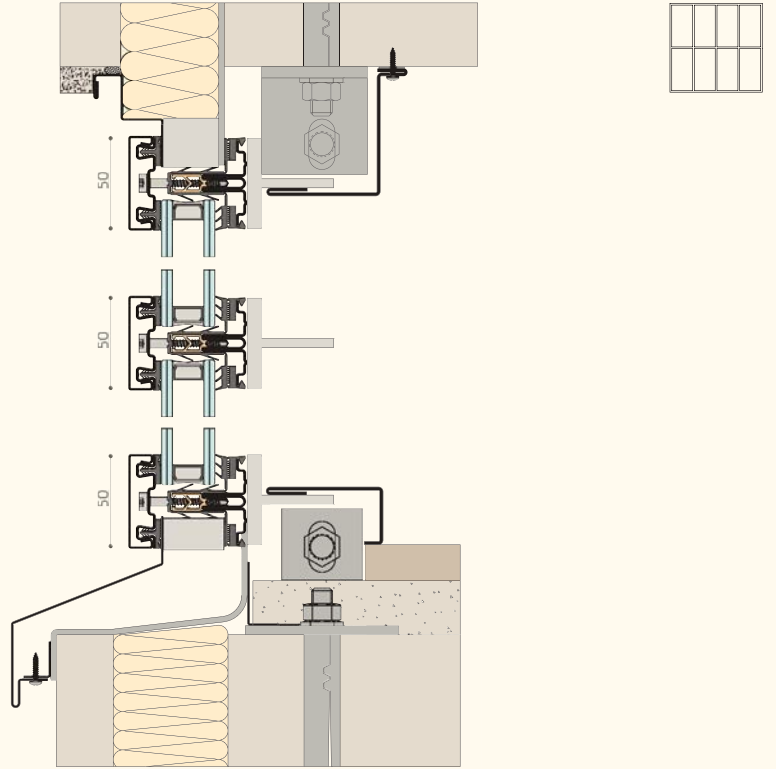

material properties

galvanized steel

ALLOY UNI 10142:90	Fe P02G
Symbol Code	DX 51D
Numerical Code	1.0226

CHEMICAL COMPOSITION	(% of the mass)
Fe	99,5
Si	0,27
Mn	0,37
P max.	0,014
S	0,009
Cr	0,071
Cu	0,25
Mo	0,016
Ni	0,012
Others	0,05

PHYSICAL FEATURES	
Specific weight (kg / dm ³)	7,87
Thermal conductivity at 20° λ (W / m K)	60
Coefficient of thermal expansion c (mm / m °C)	0,0123
Module of elasticity E (N / mm ²)	210.000
Electric conductivity Ω (Ω / mm / m)	0,0934

MECHANICAL FEATURES	
Yield Re (N / mm ²)	220 - 300
Tensile strength Rm (N / mm ²)	500
Elongation at break A _{80mm} % min	22
Vickers Scale	200 - 250

REFERENCE STANDARDS

UNI EN 10326:2004 Continuously hot-dip coated strip and sheet of structural steels - Technical delivery conditions
 UNI EN 10327: 2004 Continuously hot-dip coated strip and sheet of low carbon steels for cold forming - Technical delivery conditions

stainless steel

ALLOY	X5CrNi 18-10	X2CrNiMo 17-12-2
AlSI acronym	304	316L
DIN acronym	1.4301	1.4404

CHEMICAL COMPOSITION*	(% of the mass)	
C	≤0,07	≤0,030
Si	≤1,00	≤1,00
Mn	≤2,00	≤2,00
P max.	0,045	0,045
S	≤0,030	≤0,030
N	≤0,11	≤0,11
Cr	17,5 - 19,5	16,5 - 18,5
Mo	-	2 - 2,50
Ni	8,0 - 10,5	10 - 13
Others	-	-

PHYSICAL FEATURES*		
Specific weight (kg / dm ³)	7,91	8,00
Thermal conductivity at 20°C λ (W / m K)	17	17
Coefficient of thermal expansion (mm / m °C)	0,0103	0,0103
Module of elasticity E (N / mm ²)	196.000	196.000
Electric conductivity Ω (Ω / mm / m)	0,714	0,714
Melting point (°C)	1400 - 1420	1400 - 1420

MECHANICAL FEATURES* (for cold-rolled strip)

Tensile strength Rm (N / mm ²)	540 - 750	530 - 680
Proportionality limit stress	0,2% Rp _{0,2}	230
	1,0% Rp _{1,0}	260
Elongation at break A _{80mm} % min	45	40
	Brinell Scale HB (kg / mm ²)	<165

*UNI 10088-2:1997

REFERENCE STANDARDS

EN 10088 - 1 Stainless steel - List of stainless steels
 EN 10088 - 2 Stainless steel - Material standard for stainless steel sheet, plate and strip for general purposes
 EN 10088 - 2 Stainless steel - Material standard for stainless steel semi-finished products, bars, rods and sections for general purposes
 EN 114 - Determination of the resistance to the corrosion for austenitic stainless steel

corten steel

ALLOY	(Corten A)
EN 10027 - 1 ECISS IC10	S355J0WP

CHEMICAL COMPOSITION	(% of the mass)
C max	0,12
Si max	0,75
Mn max	1,0
P	0,06 - 0,15
S max	0,04
Ni max	0,65
Cr	0,30 - 1,25
Cu	0,25 - 0,55

PHYSICAL FEATURES	
Specific weight (kg / dm ³)	7,87
Thermal conductivity at 20°C λ (W / m K)	60
Coefficient of thermal expansion c (mm / m °C)	0,0108
Module of elasticity E (N / mm ²)	210.000
Electric conductivity Ω (Ω / mm / m)	0,0934

MECHANICAL FEATURES	
Yield Re (N / mm ²)	355
Tensile strength Rm (N / mm ²)	510 - 680
Elongation at break A _{80mm} % min	< 1,5 ≤ 2 14 - 16 < 2 ≤ 2,5 15 - 17 < 2,5 ≤ 3 16 - 18

REFERENCE STANDARDS

UNI EN 10131 Cold rolled uncoated and zinc or zinc-nichel electrolytically coated low carbon and high yield strength steel flat products for cold forming - Tolerances on dimensions and shape

brass (OT67 copper alloy)

ALLOY	Cold rolled laminate 10 H10
Alloy code	CW 506L
Designation	R350 / H095

CHEMICAL COMPOSITION*	(% of the mass)
Cu	66 - 68
Pb max	0,20
Fe max	0,15
Al max	0,05
Sn max	0,20
Si max	0,15
Mn max	0,10
Ni max	0,30
impurità	0,40
Zn	resto

PHYSICAL FEATURES*	Cold rolled laminate 10 H10
Specific weight (kg / dm ³)	8,50
Specific heat capacity at 20°C (cal / g)	0,09
Thermal conductivity at 20°C [cal / (s cm °C)]	0,278
Linear thermal expansion coefficient - 25 to 300°C (1 / °C)	20,2 x 10 ⁻⁶
Electrical resistivity an 20 °C (μ Ω cm)	6,63
Module of elasticity E (N / mm ²)	110.000
Melting point (°C)	905 - 940
Structure	Alfa

MECHANICAL FEATURES*	Cold rolled laminate 10 H10
Ultimate tensile strength R (N / mm ²)	350 - 430
Yield strength S _(0,2) (N / mm ²)	200 - 360
Elongation A ₅ (min %)	23
Brinell Scale HB	95 - 125

*UNI 4894:1962

REFERENCE STANDARDS

UNI EN 1652: Copper and copper alloys - Plate, sheet, strip and circles for general purposes

Secco Sistemi spa

via Terraglio 195

31022 Preganziol TV - Italy

tel. +39 0422 497700

fax +39 0422 497705

info@seccosistemi.it

www.seccosistemi.it



METALFORM

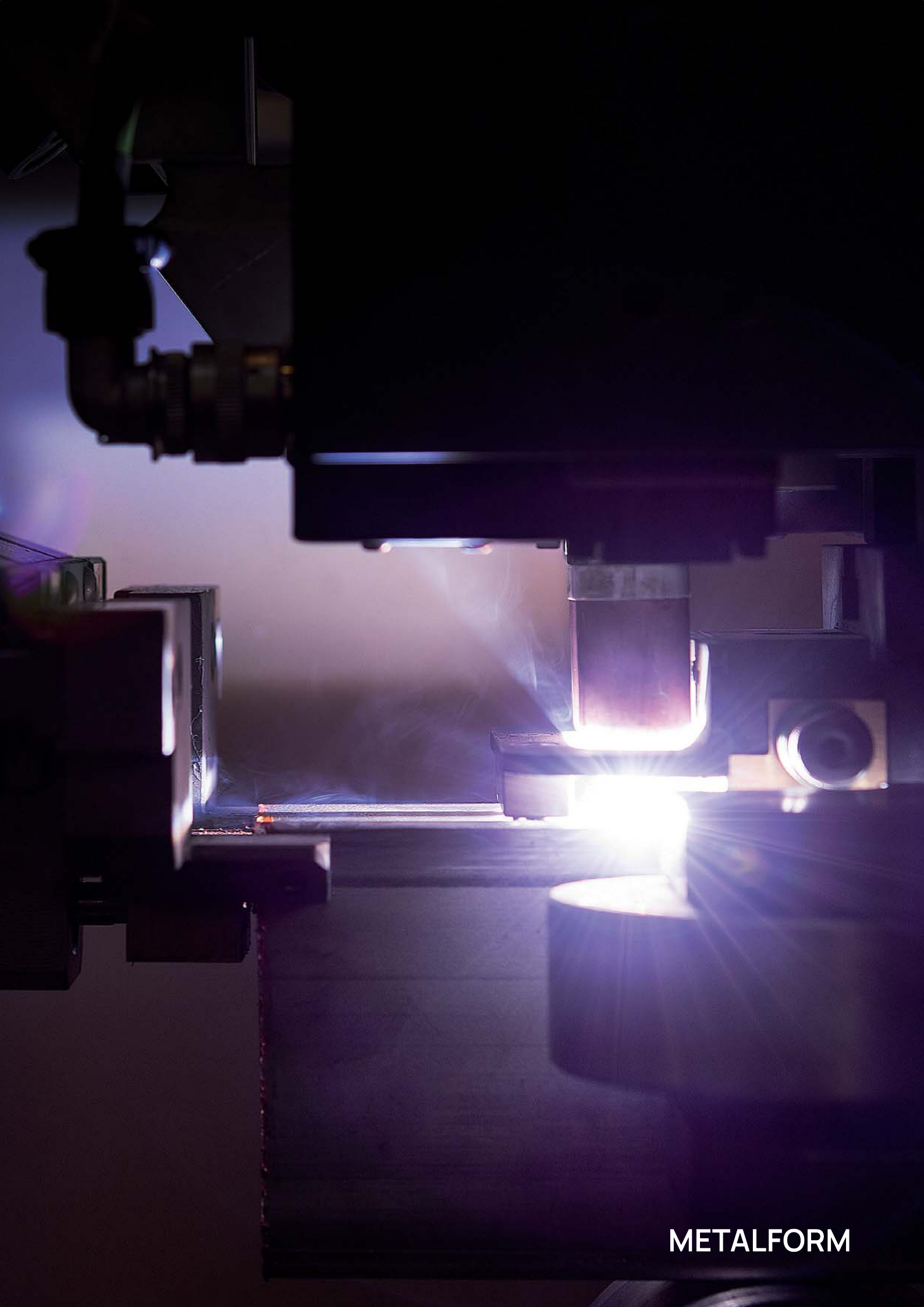

METALFORM

4F because

- **facade** available in four materials for the **mullions**:
galvanised steel, stainless steel, corten steel
- **facade** available in five materials for the **covers**:
galvanised steel, stainless steel, corten steel and brass
- **perfect architectural integration** with Secco Sistemi for doors and windows
- **customisation of profiles** for special projects
- size of only **50 mm**
- mullions and transoms **50 mm to 180 mm deep**
- snap joint between mullions and transoms and **gaskets**
with very clean lines
- high structural resistance of mullions with subsequent
possibility to resize glazing and the entire facade
- **high-performance values** of air tightness, water tightness,
wind resistance and thermal insulation
- fire resistance performance up to **EI 90**



Secco Sistemi spa
via Terraglio 195
31022 Preganziol TV - Italy
tel. +39 0422 497700
fax +39 0422 497705
info@seccosistemi.it
www.seccosistemi.it

METALFORM

METALFORM

MASTERS OF METAL

UNITED KINGDOM

METALFORM

NORWAYMETAL LTD

53 Chelsea Manor Street

London, SW3 5RZ

SALES@METALFORM.UK

+44 20 81298814

GERMANY

METALFORM GMBH

Carl-Zeiss-Ring 15A

85737 Ismaning

SALES@METALFORMGROUP.DE

+49 17663630406

NORWAY

METALFORM AS

Brochmannsveien 2

1950 Rømskog

SALG@METALFORM.NO

+47 401 62 446

METALFORMGROUP

SALES@METALFORMGROUP.COM