



Fire protection

Smoke and fire doors and glazing

METALFORM
JANSEN

Functional fire protection in its most beautiful form

Steel is neither flammable, nor does it suffer any significant loss of its inherent stability in the event of a fire. For this reason, it is predestined for use as a material in the fabrication of fire doors and glazing.

Fire doors made from steel can help to save lives in cases of emergency. Whether in private, commercial or public buildings - fire doors are used to separate fire compartments and significantly delay the spread of smoke and fire. Thanks to their insulating properties, they counteract an increase in temperature on the side facing away from the fire, which helps to secure the escape routes in stairwells or corridors, for example.

Numerous approvals in different countries attest to the quality of the Jansen products, which cover a variety of fire resistance classes and therefore a wide range of applications.

The approvals are continually improved and extended as a result of an active exchange with users and building authorities.

The tried-and-tested fire and smoke protection systems from Jansen combine functionality, flexibility and aesthetics. With these profile systems, narrow profile face widths are also possible for high security requirements.

The option to combine the different fire doors and glazing types provides the basis for holistic and economical system solutions whilst also meeting protection objectives.





METALFORM

Jansen-Economy E30/EW30/E60/EW60 Fire doors



Jansen-Economy 50 E30/EW30/E60/EW60

E30/EW30/E60/EW60 smoke/fire doors and closures made from steel and stainless steel successfully prevent the spread of flames and smoke in the event of a fire. Jansen-Economy 50 allows transparent building components to be manufactured economically. The basic depth for door frames and leaves is only 50 mm.

Flush-fitted doors with a continuous shadow joint inside and outside can be fabricated with this profile system. In the event of fire, a low flammability double rebate gasket guarantees a secure barrier.

Jansen-Economy 60 E30/EW30/E60/EW60

The profile system with a basic depth of 60 mm is especially suitable for all applications which require large E30/EW30/E60/EW60 smoke/fire closures with a slimline look. The robust and extremely torsion-proof Jansen-Economy 60 E30 steel profiles allow the production of solid single and double-leaf door systems. The tailored range of fittings includes locks, strike plates, electric strikes, door handles and specially developed 3D-adjustable weld-on or screw-on hinges.

The appearance is coordinated to match the other Jansen door systems. In this way, different requirements can be met with a single uniform appearance.



Example of Jansen-Economy 50 E30/EW30/E60/EW60 doors

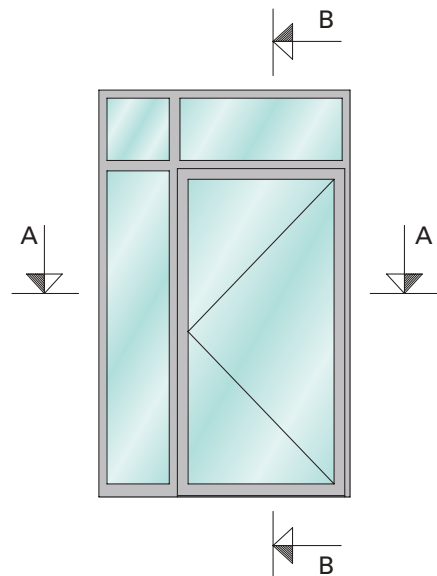
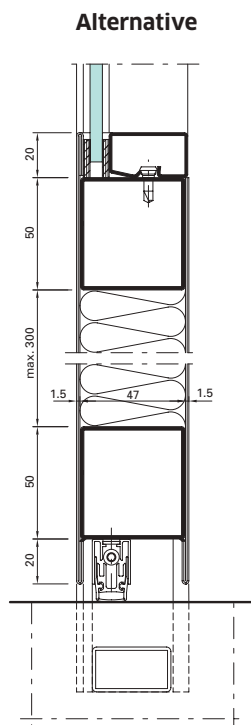
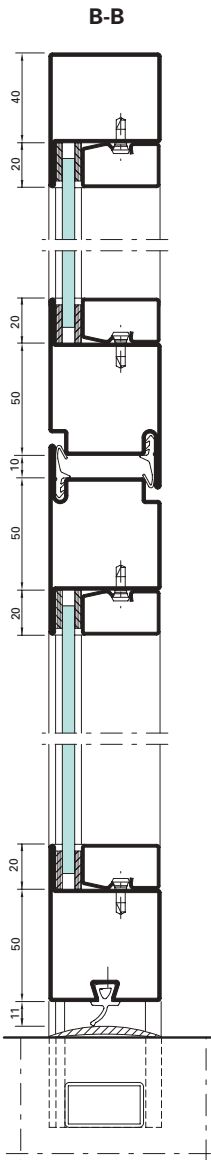
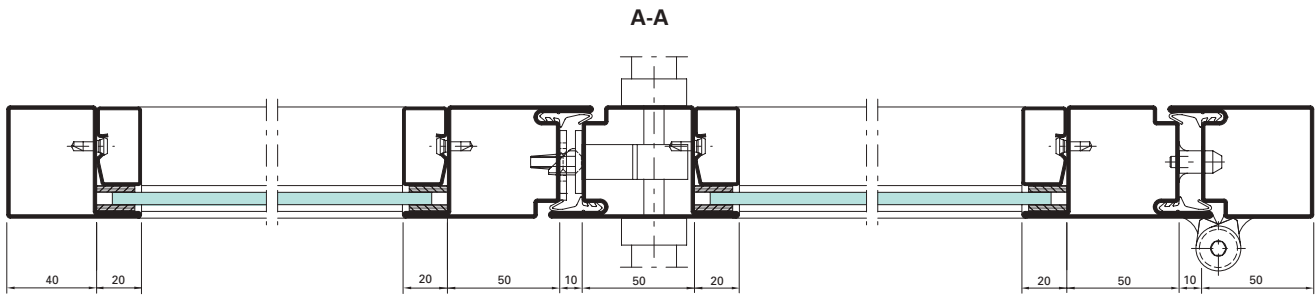

METALFORM

Example of Jansen-Economy 60 E30/EW30/E60/EW60 doors

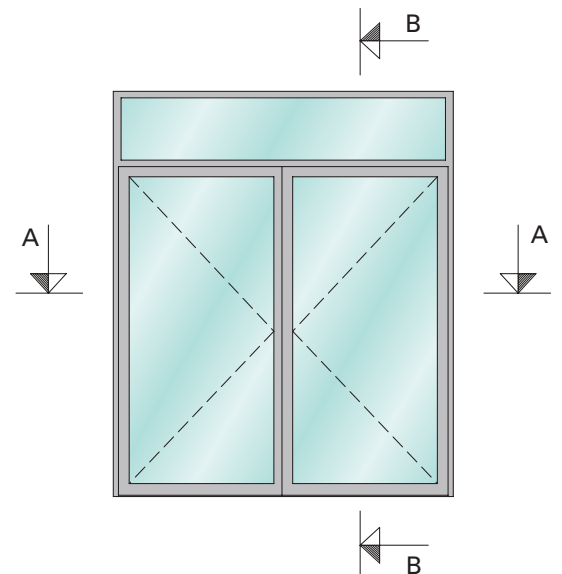
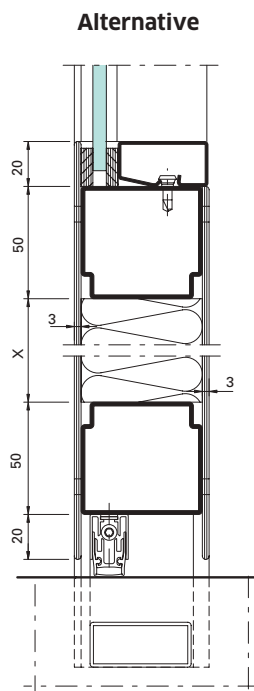
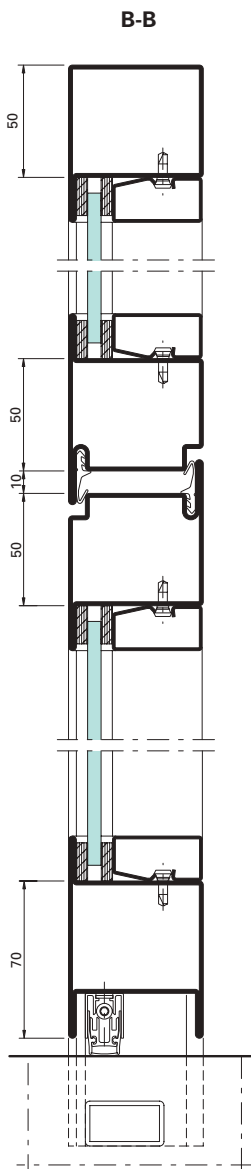
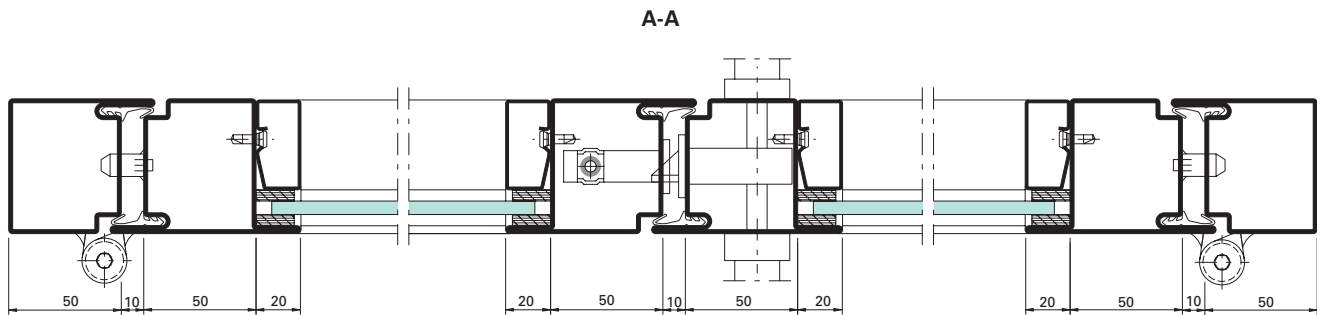



University of Technology,
information, communication and
media center, Wildau/DE
(Janisol, Janisol Primo, VISS TVS Linea,
Jansen-Economy 60 RS)

METALFORM

Jansen-Economy RS Smoke doors



Jansen-Economy 50 RS

The Jansen-Economy 50 RS system, which is made from steel and stainless steel, offers clear benefits in terms of security and cost. The simple geometry of the profiles with a basic depth of 50 mm allows efficient fabrication of flush-fitted, single and double-leaf smoke doors in accordance with DIN 18095 and EN 1634-3.

A comprehensive range of tested, system-specific fittings and door handles in aluminium or stainless steel ensures that the units are fabricated to the correct standards. Locks and fittings can be integrated easily into the hollow profile section.

Jansen-Economy 50 RS is virtually identical in appearance to EI30 fire protection barriers from the Janisol 2 system.

Jansen-Economy 60 RS

A complete profile system for single and double-leaf door systems in accordance with DIN 18095 and EN 1634-3 that also enables large units with the familiar narrow face widths and includes a comprehensive range of system-specific and approved locks and fittings. The door closer integrated into the profile offers an attractive solution. As it can also be created cost-effectively with the Jansen-Economy 60 profile system, it is an attractive feature even for larger building components.

Jansen-Economy 60 RS is also approved as a burglar-resistant door in accordance with DIN EN 1627 and corresponds to resistance class RC3.



Example of Jansen-Economy 50 RS doors

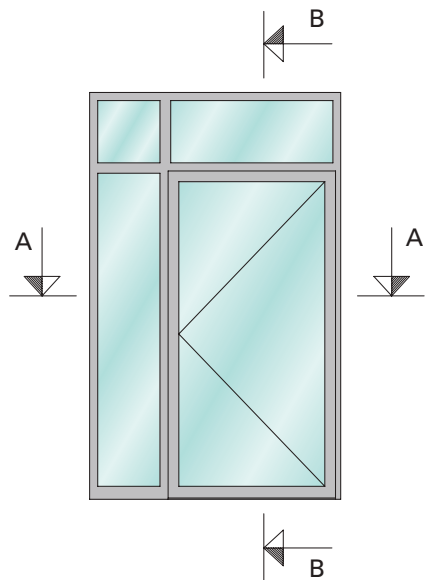
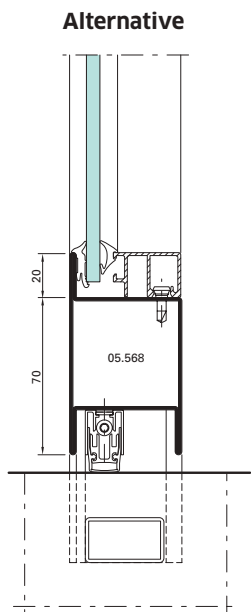
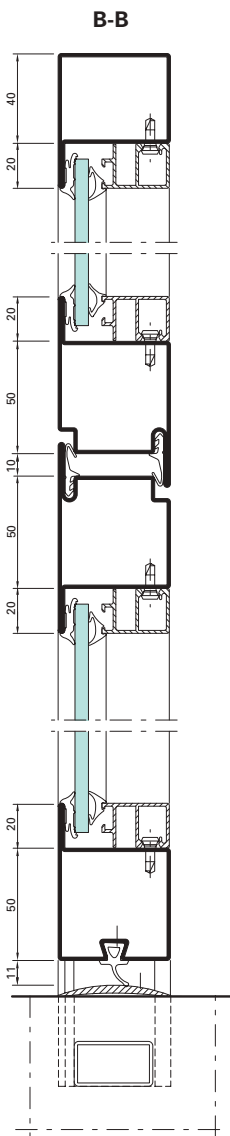
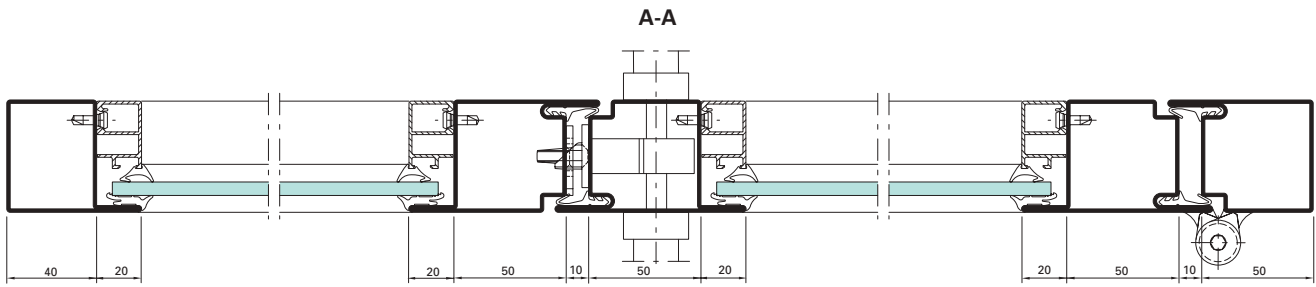

METALFORM

Example of Jansen-Economy 60 RS doors

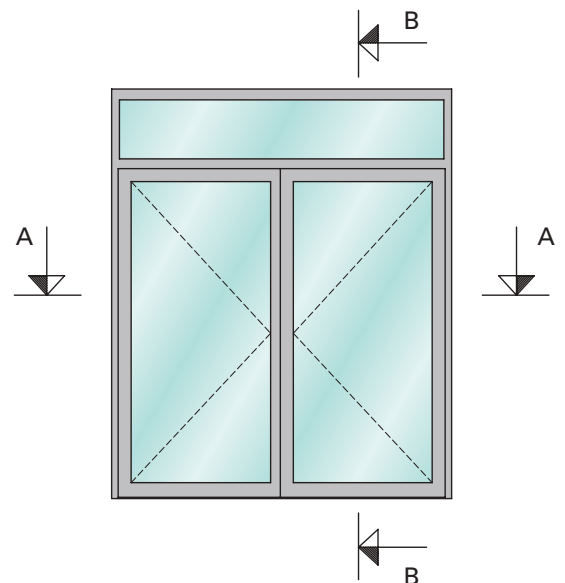
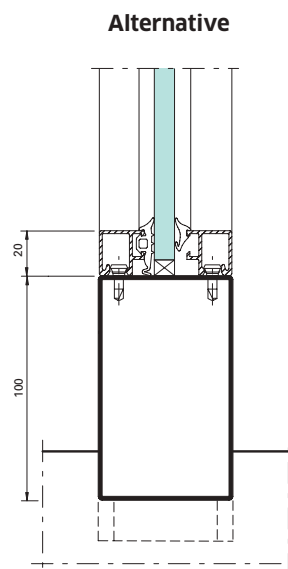
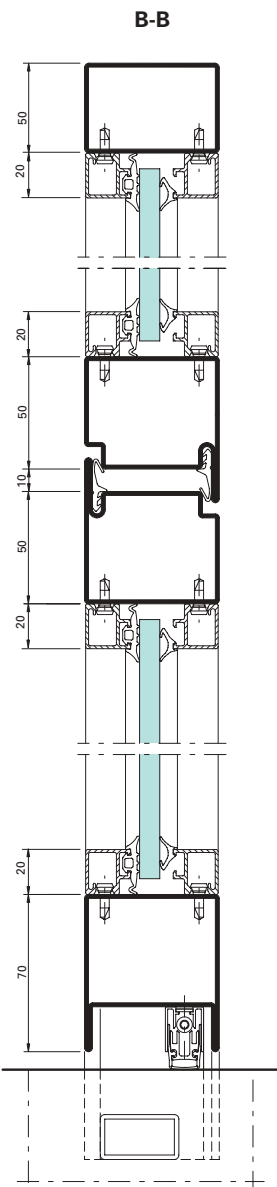
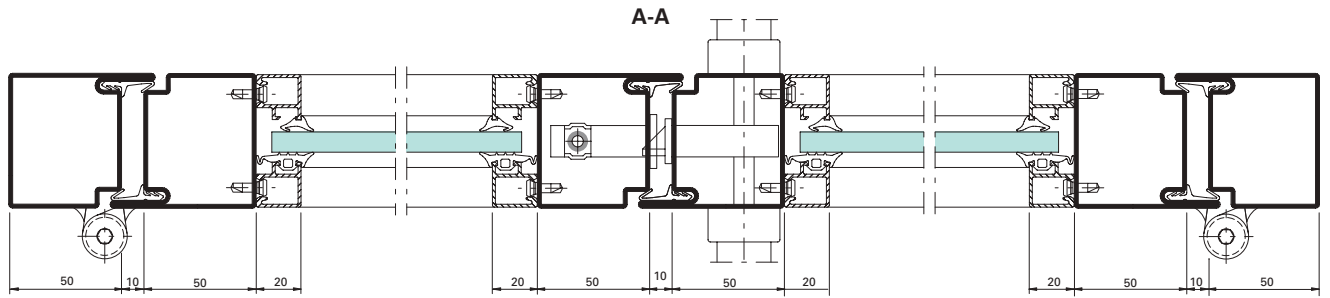

Profile range

Jansen-Economy 50

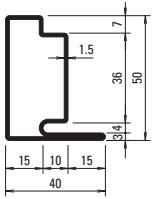

30.006
30.006 Z
30.006.01

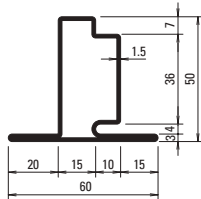

30.106
30.106 Z

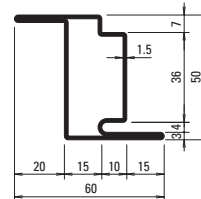

30.406
30.406 Z

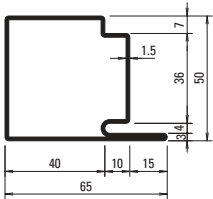

30.007
30.007 Z
30.007.01

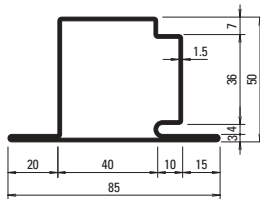

30.107
30.107 Z
30.107.01

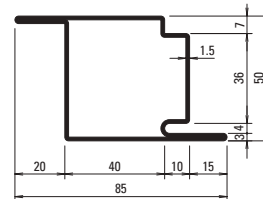

30.407
30.407 Z
30.407.01

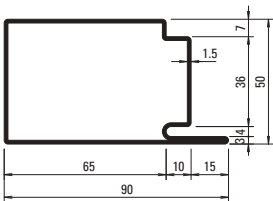

30.008
30.008 Z

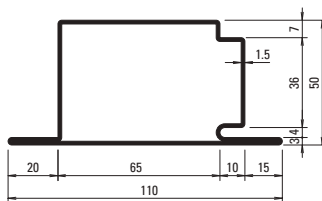

30.108
30.108 Z

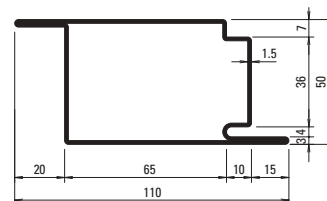

30.408
30.408 Z

Z = strip galvanised steel

01 = Stainless steel, bright,
Material 1.4404 (AISI 316L)

The stainless steel profiles are also available with a finished design. The visible surfaces can be ordered with a grain finish 220-240.

METALFORM

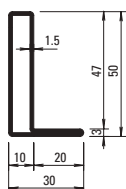

01.531
01.531 Z

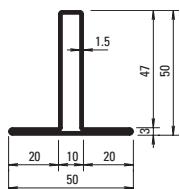

02.531
02.531 Z

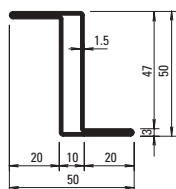

03.531
03.531 Z

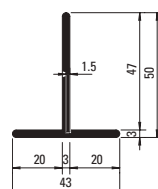

400.023
400.023 Z

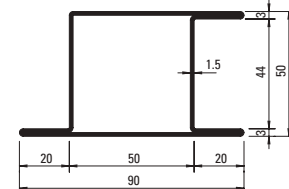

05.568
05.568 Z
[05.568.01](#)

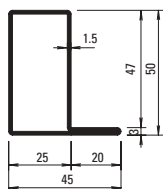

01.534
01.534 Z
[01.534.01](#)

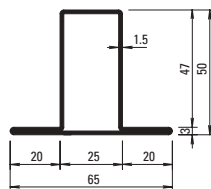

02.534
02.534 Z
[02.534.01](#)

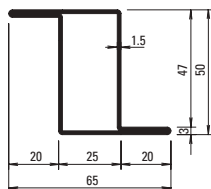

03.534
03.534 Z

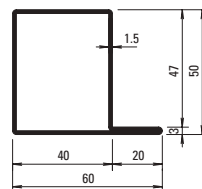

01.564
01.564 Z
[01.564.01](#)

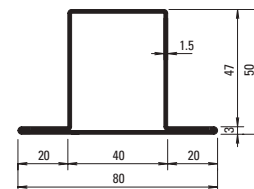

02.564
02.564 Z
[02.564.01](#)

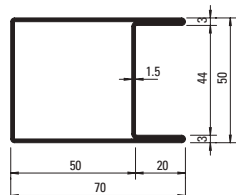

04.568
04.568 Z

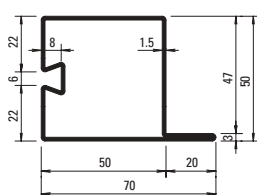

32.388
32.388 Z

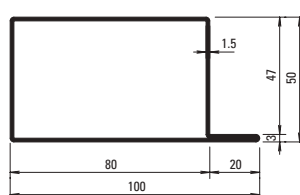

01.592
01.592 Z

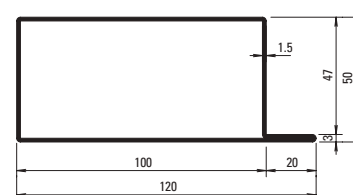

01.596

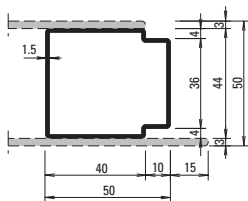

81.009 Z

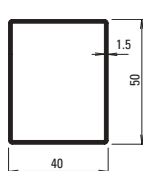

400.048
400.048 Z

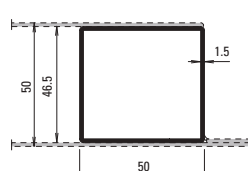

400.049
400.049 Z

Profile range

Jansen-Economy 60

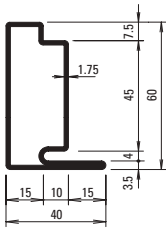

30.018
30.018 Z

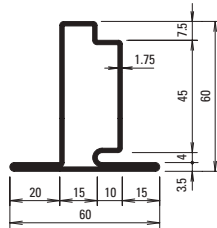

30.118
30.118 Z

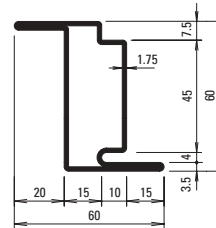

30.418
30.418 Z

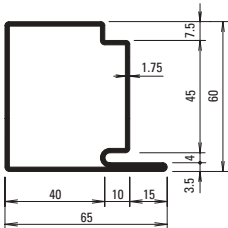

30.019
30.019 Z

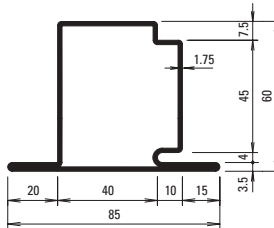

30.119
30.119 Z

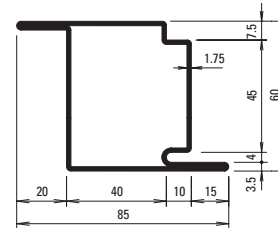

30.419
30.419 Z

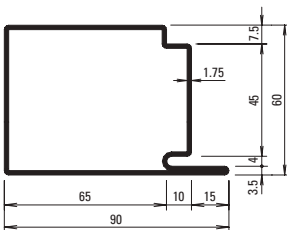

30.017
30.017 Z

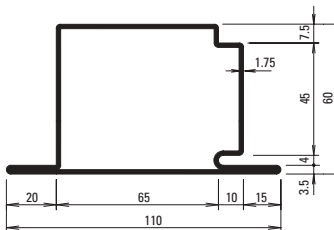

30.117
30.117 Z

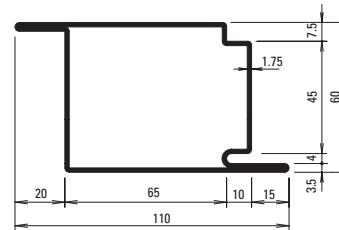

30.415

Z = strip galvanised steel

METALFORM

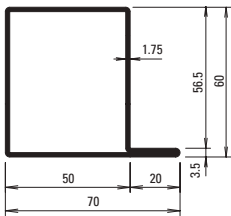

01.684
01.684 Z

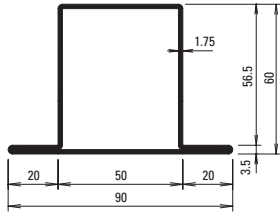

02.684
02.684 Z

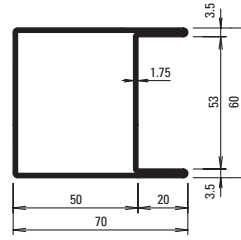

04.637
04.637 Z

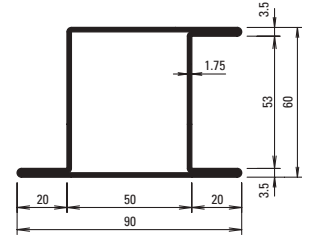

05.637
05.637 Z

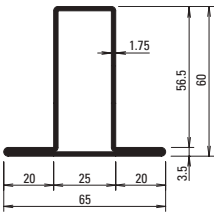

02.634
02.634 Z

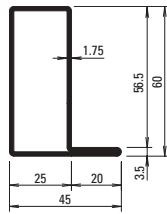

01.634
01.634 Z

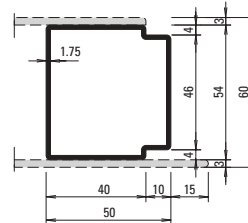

81.010 Z

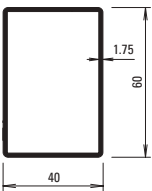

400.052
400.052 Z

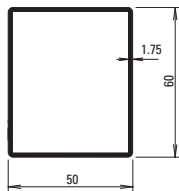

400.054
400.054 Z

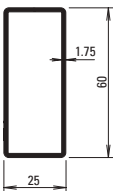

400.055
400.055 Z

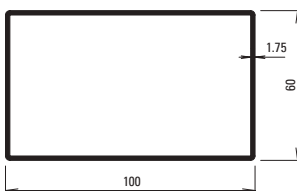

400.051
400.051 Z

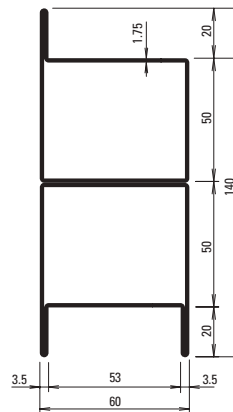

05.001

Janisol 2 EI30

Fire doors



Secure fire containment

The thermally broken Janisol 2 EI30 profile system enables the efficient and reliable fabrication of single and double-leaf doors, fire-resistant glazing and doors in glass walls. The basic depth for door frames and door leaves is just 60 mm.

Profiles with face widths of 25, 50 and 85 mm can be used for mullions and transoms. A continuous shadow joint inside and outside lends the construction a certain lightness and elegance with

extremely narrow profile face widths. Fire-resistant glazing from a variety of providers can be used for infill units. A comprehensive range of fully tested fittings, locks, accessories and integrated door closers is also available. These can be integrated very easily into the hollow profile section. The appearance is coordinated to match that of all the other Jansen door systems. Janisol 2 EI30 has many approval certificates. These are constantly being

extended and improved in consultation with users and the building authorities. The many successfully tested system variations allow particularly cost-efficient, attractive and complex project solutions in line with objectives. Janisol 2 EI30 doors have also been tested as burglar-resistant doors in accordance with EN 1627, classified in resistance class RC3 and are approved as smoke doors in accordance with DIN 18095 and EN 1634-3.



METALFORM

Sheet metal clad fire doors for high design standards

Janisol 2 EI30 sheet metal clad fire doors can be fabricated as single and double-leaf doors with or without glazed sections. The door leaf and outer frame profiles are flush-fitted and therefore lend the construction an elegant appearance. The system provides plenty of scope for creativity whether it is with glazed side sections or toplights.

Janisol 2 sheet metal clad fire doors are characterised not only by their appearance, but also by their simple and efficient fabrication. Smooth sheets can be welded or bonded, removing the need for complicated folding of the sheet metal. In addition, all Janisol 2 fittings can be used; vertical joint and horizontal safety bars are easy to attach.



Anti-finger-trap doors for added safety

A further variation of the Janisol 2 EI30 system is a door with finger-trap protection. The rounded half profiles at the secondary closing edge minimise the risk of potential injury. This door design is particularly suitable for busy public buildings, such as schools, shopping centres, railway stations or airports.

It is simple and efficient to fabricate, and has low maintenance requirements thanks to a high-performance hinge bush. The anti-finger-trap option can be integrated seamlessly into the overall appearance as it looks exactly the same as the systems without finger-trap protection.



Our technical consultancy service would be happy to help you with requirements for individual projects or specific countries.



LAUTSPRECHER
LOUDSPEAKER

Example of Janisol 2 EI30

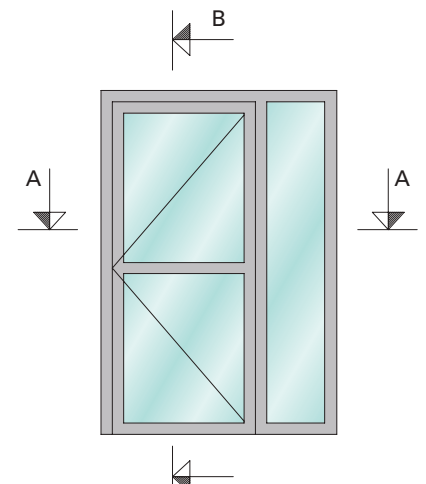
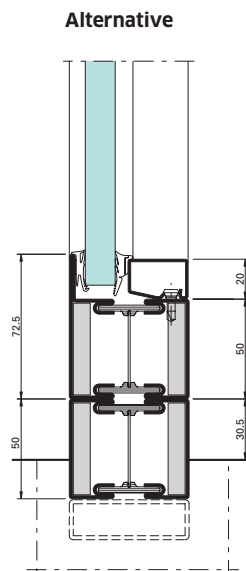
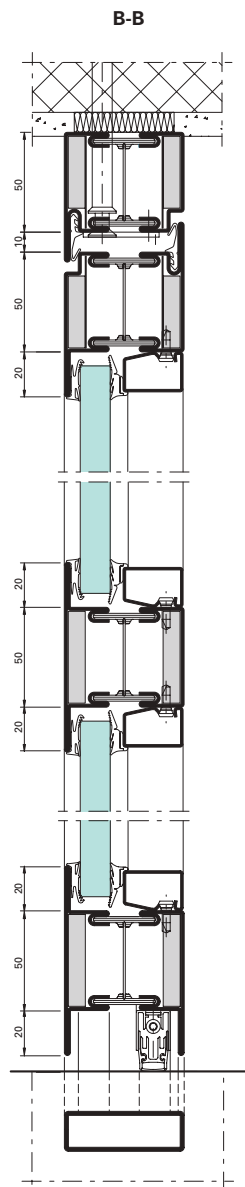
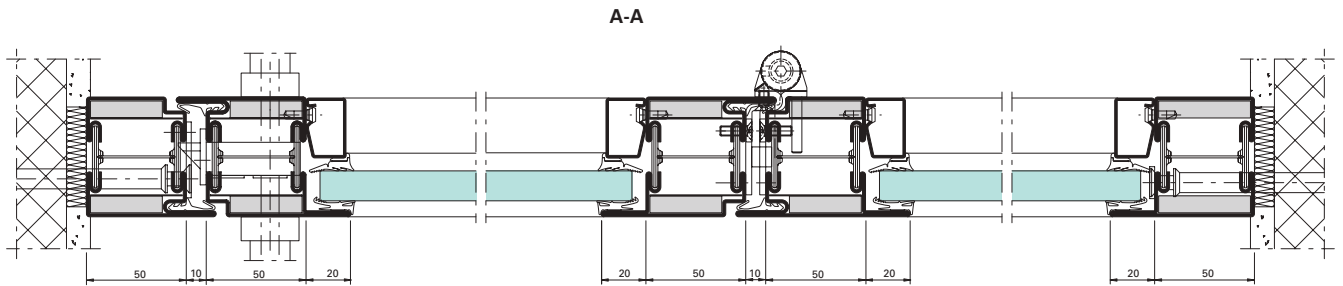

Janisol 2 EI30

Fire-resistant sliding doors



Extremely narrow profile with maximum safety features

The Janisol 2 EI30 fire-resistant sliding door is used in busy buildings requiring easy access, such as shopping centres, stadia or office buildings. The automatic door system has been successfully tested to fire-resistance class EI30 in accordance with EN 1634 with and without integrated emergency exit function, as well as with a wide variety of motors, glass inserts and panels. The maximum clear opening dimensions are 1400 × 2500 mm for single-leaf constructions, and 2800 × 2500 mm for

double-leaf constructions. Door leaf and door frame profiles with a face width of 25 or 50 mm are currently the slimmest fire-resistant steel profiles on the market. A key benefit is simple and reliable fabrication. Thanks to the new special profile filled with ceramic compound for the outer and vent frames, no complex work is necessary for the sheet edge, and no additional fire-resistant panels are required. There is also no need for a floor guide in the entrance area.



METALFORM

Unit overview

Janisol 2 EI30 fire-resistant sliding doors (selection)

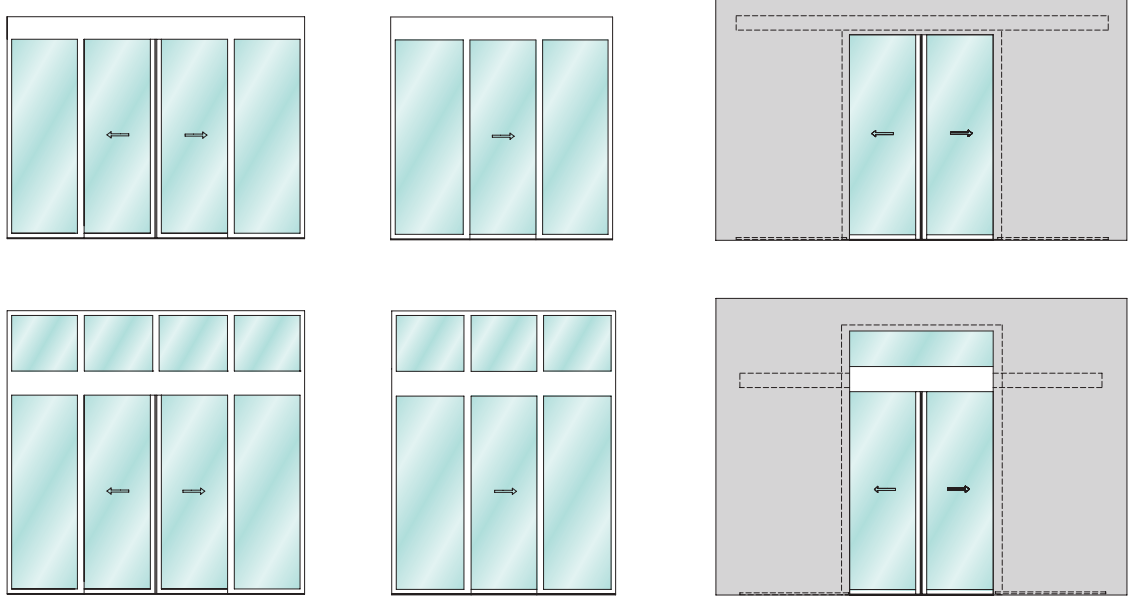

Janisol 2 EI30 fire-resistant sliding doors with "Break-Out" emergency exit function (selection)

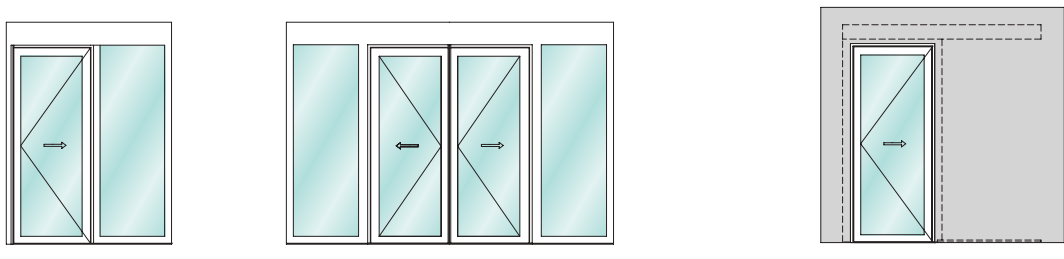

Janisol 2 EI30 fire-resistant sliding doors with "Break-In" emergency exit function (selection)

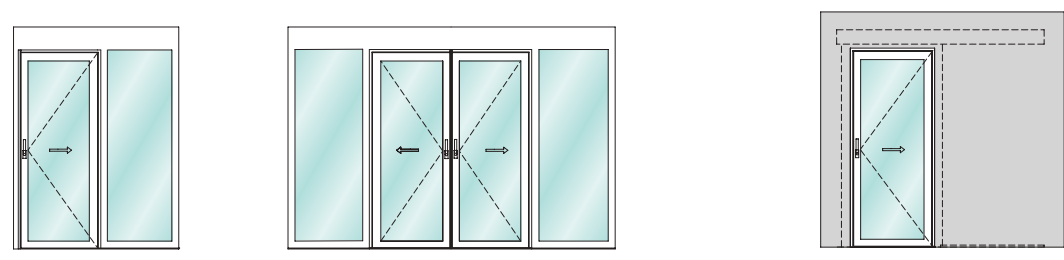

Example of Janisol 2 EI30 fire-resistant sliding door
without emergency exit function

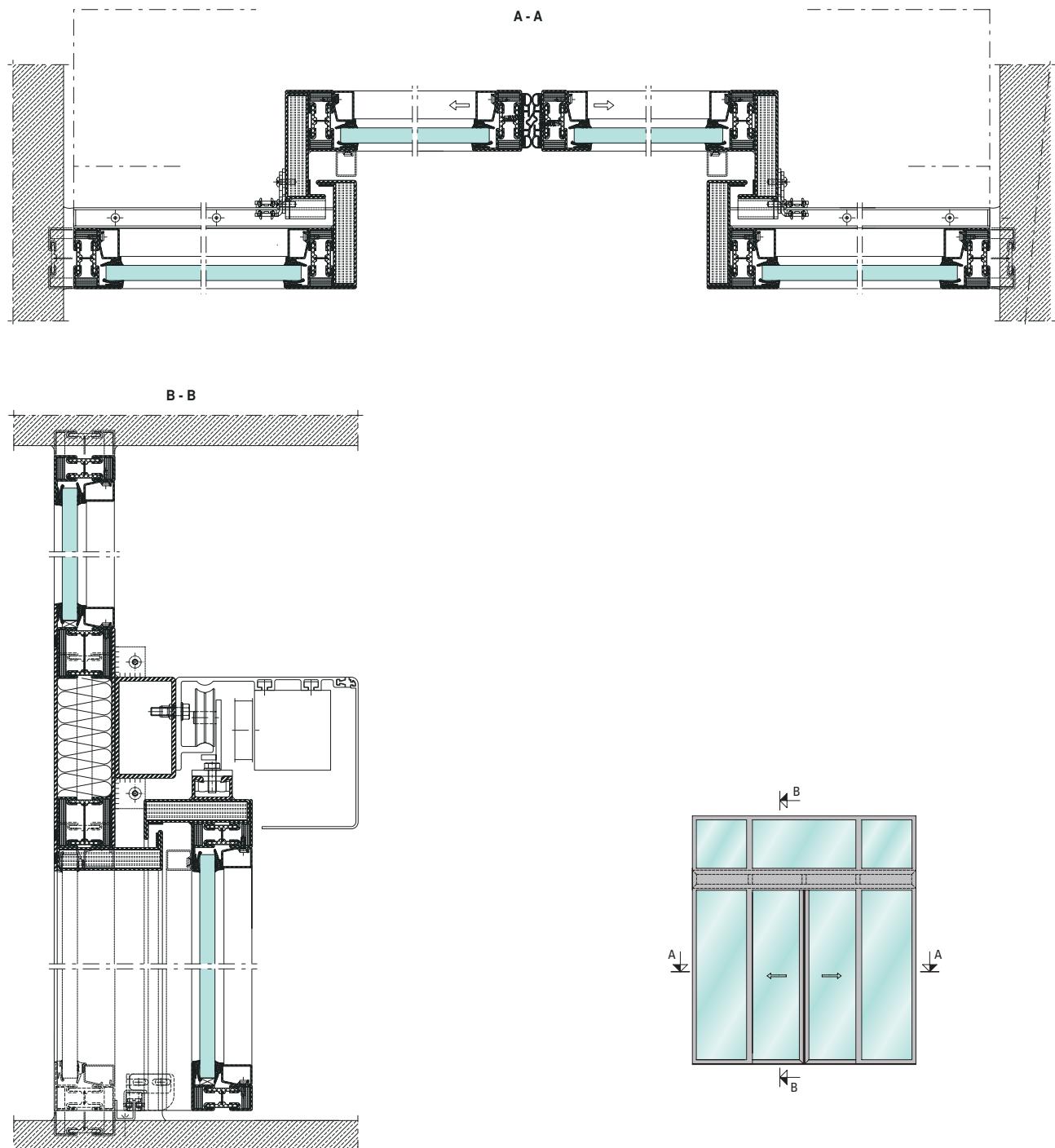

METALFORM

Example of Janisol 2 EI30 fire-resistant sliding door with break-out emergency exit function

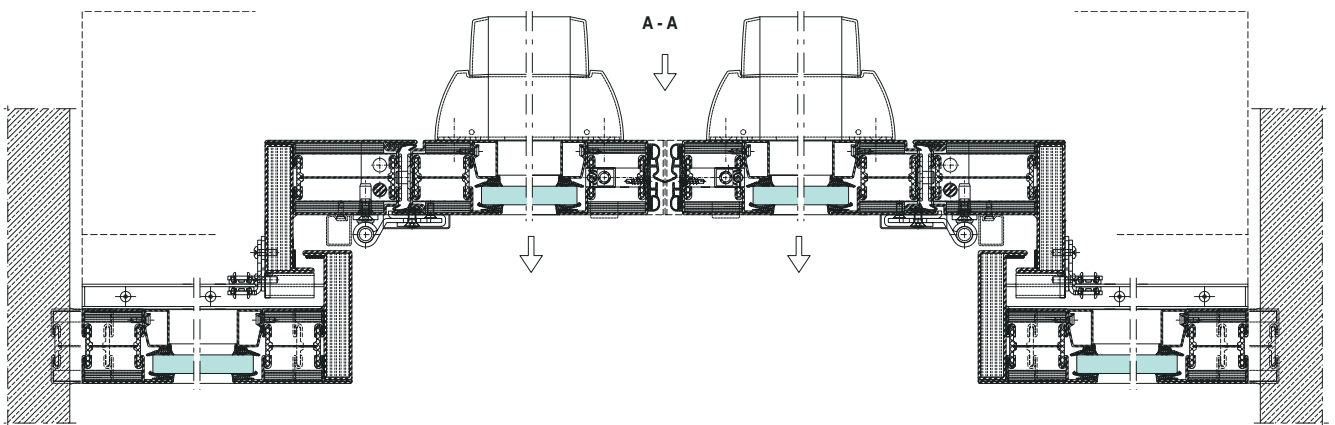

Version with "break-in" emergency exit function

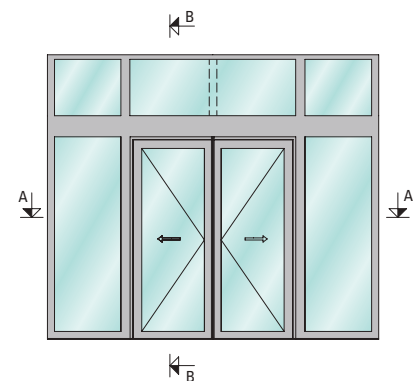
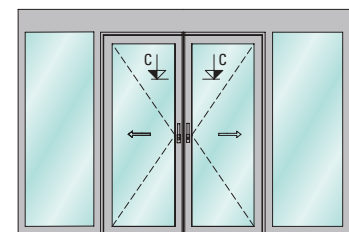
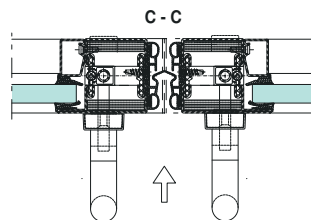
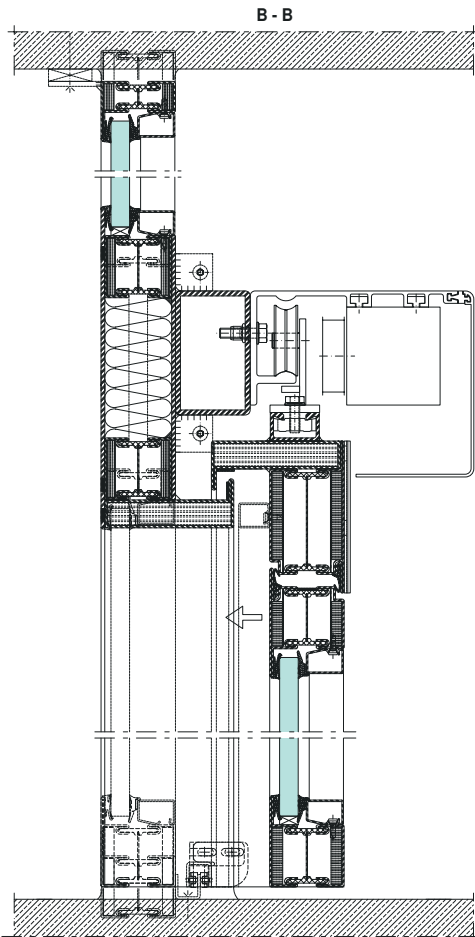

Profile range

Janisol 2 EI30

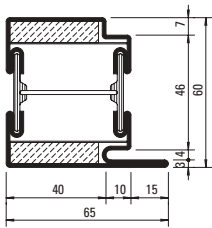

630.013.2
630.013.2 Z
[630.013.21](#)

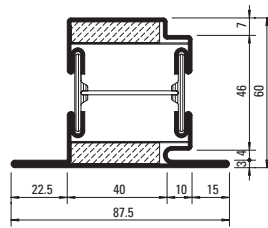

630.114.2
630.114.2 Z
[630.114.21](#)

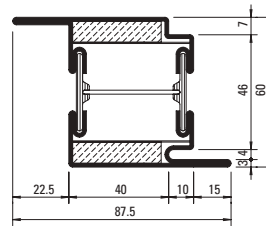

630.416.2
630.416.2 Z
[630.416.21](#)

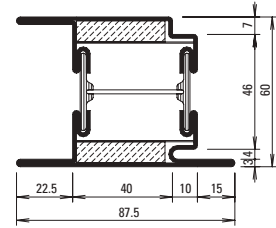

630.428.2
630.428.2 Z

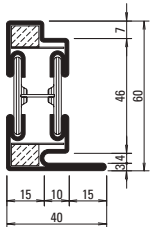

630.010.2 Z

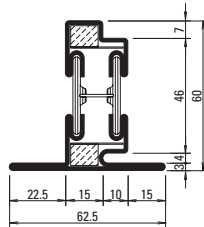

630.110.2 Z

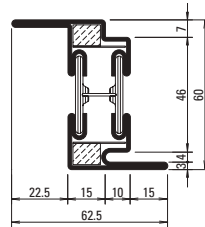

630.411.2 Z

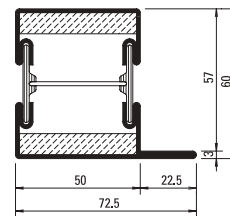

601.685.2
601.685.2 Z
[601.685.21](#)

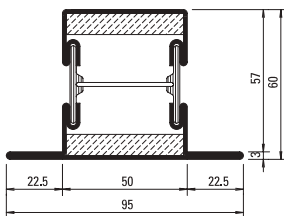

602.685.2
602.685.2 Z
[602.685.21](#)

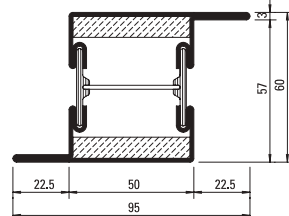

603.685.2
603.685.2 Z

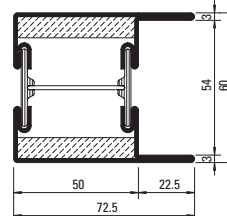

604.685.2
604.685.2 Z

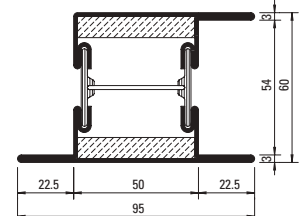

605.685.2
605.685.2 Z
[605.685.21](#)

METALFORM

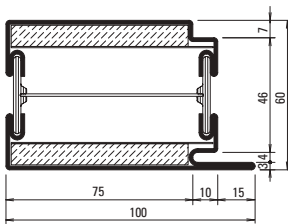

630.016.2
630.016.2 Z
630.016.21

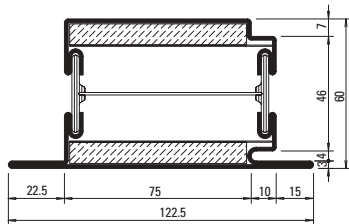

630.115.2
630.115.2 Z
630.115.21

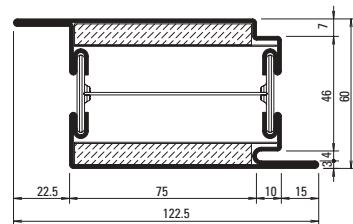

630.417.2
630.417.2 Z
630.417.21

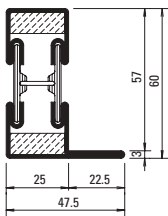

601.635.2
601.635.2 Z

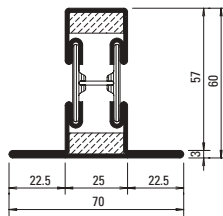

602.635.2
602.635.2 Z

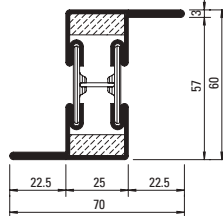

603.635.2
603.635.2 Z

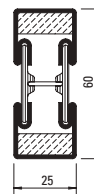

600.006.2
600.006.2 Z

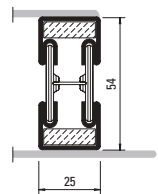

600.008.2 Z

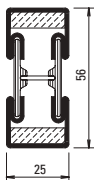

600.002.2
600.002.2 Z

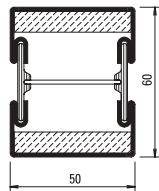

600.005.2
600.005.2 Z
600.005.21

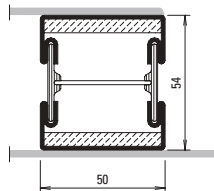

600.007.2 Z

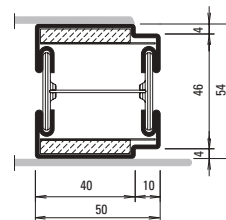

600.010.2 Z

Z = strip galvanised steel

21 = Stainless steel, bright,
Material 1.4401 (AISI 316)

Janisol C4 EI60/EI30 Fire doors



Janisol C4 EI60 and Janisol 2 EI30: a new combination of reliable fire protection systems

Increased requirements for security within a building mean that the demand for functional interaction between different fire protection requirements is becoming more and more frequent. Depending on the specific national regulation, this affects, for example, stairwells that serve as an escape route in emergencies. So that technically demanding combinations also fulfil aesthetic requirements, individual door profiles from the tried-and-tested Janisol 2 EI30 fire protection system were enhanced through the addition of a basic depth of 70 mm. As a result, transparent Janisol C4 EI60 fire walls - in extreme cases even EI90 fire walls - can now be combined with Janisol 2 EI30 doors with ease. The extended range of steel profiles includes door, transom and sill rail profiles in raw and galvanised finishes. Take account of national approvals.

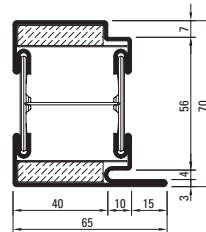

630.013.5
630.013.5 Z

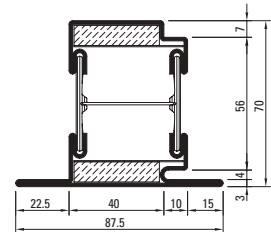

630.114.5
630.114.5 Z

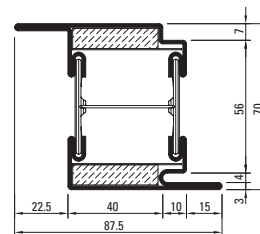

630.416.5
630.416.5 Z

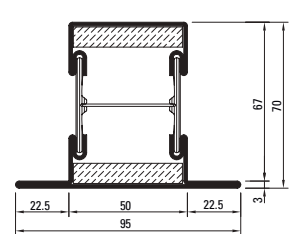

602.685.5
602.685.5 Z

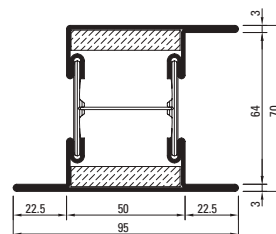

605.685.5
605.685.5 Z

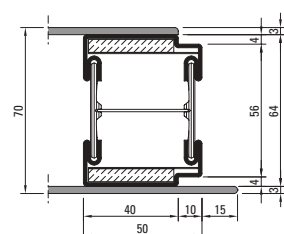

600.010.5 Z

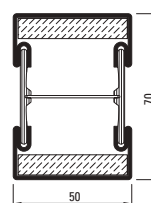

600.005.5
600.005.5 Z

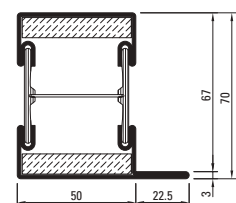

601.685.5
601.685.5 Z

METALFORM

Example of Janisol C4 EI60/EI30 (70 mm)

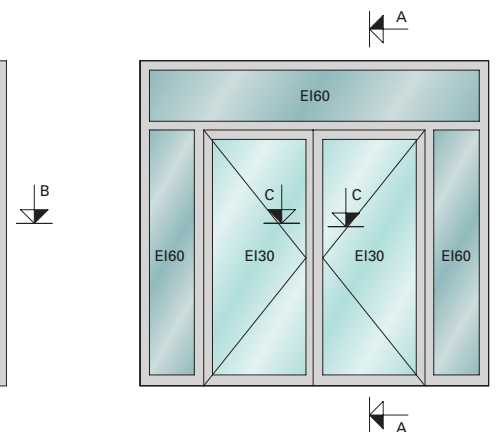
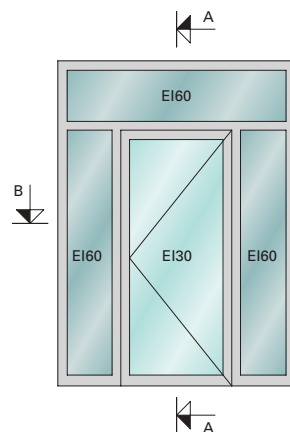
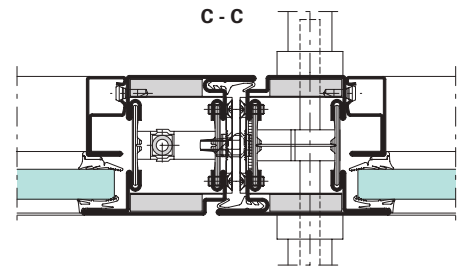
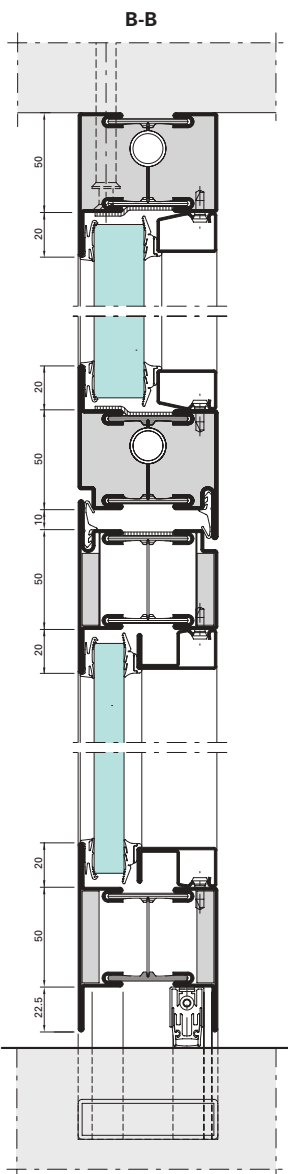
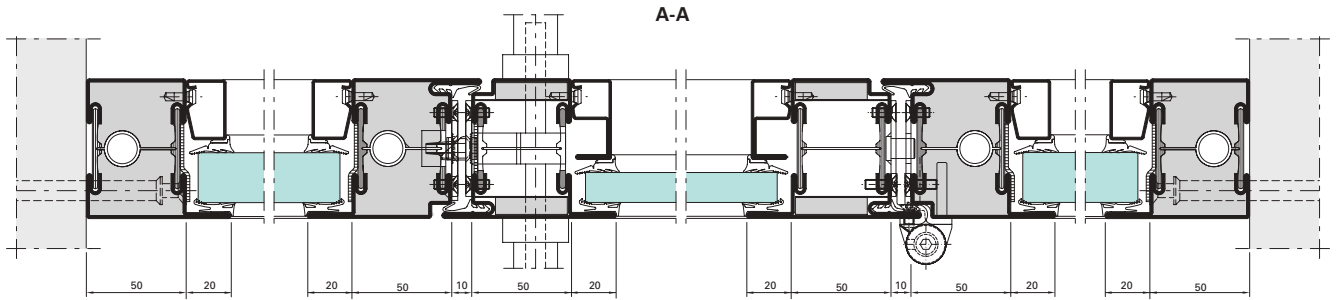



METALFORM

Janisol C4 EI60 and EI90 Fire doors



Maximum fire protection

Janisol C4 is a complete profile system for glazed single- and double-leaf fire doors and glazing. The profiles with a basic depth of just 70 mm achieve security classifications up to EI90 due to the innovative fire-resistant infill panels. The profiles are filled with a ceramic fire board in the factory. This board forms a strong attachment to the steel profile, which is not adversely affected by fabrication steps such as cutting or creating lock recesses. Due to its chemical properties, the ceramic board does not affect the steel surface finish, even on contact with fluids. Consequently, rolled steel profiles can also be filled.

As these constructions are often used for emergency escape routes, an electrical connection to monitoring devices and alarm systems is often required. Janisol C4 profiles are therefore supplied with a cable duct as standard, which allows very simple and secure electrical connections. It can be retrofitted, if required.

The appearance of the Janisol C4 fire-resistant construction is identical to the other Jansen fire protection barriers and the thermally insulated Janisol systems.

Janisol C4 permits the use of particularly narrow outer frame profiles. The fabricator has recourse to a wide selection of various glass thicknesses and panels. Centre glazing is also possible. The profile range, fittings, accessories and fabrication aids are identical for EI60 and EI90. The only difference is the choice of glazing. The result is maximum efficiency in planning and storage, as well as in fabrication and installation.



Example of Janisol C4 EI60

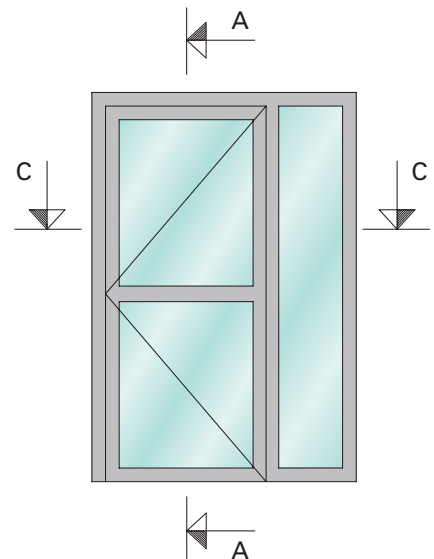
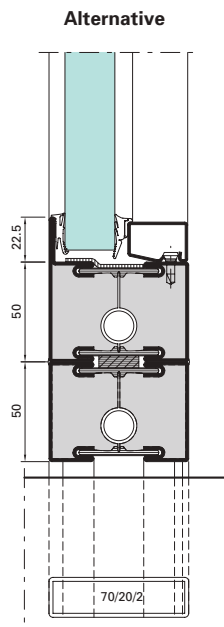
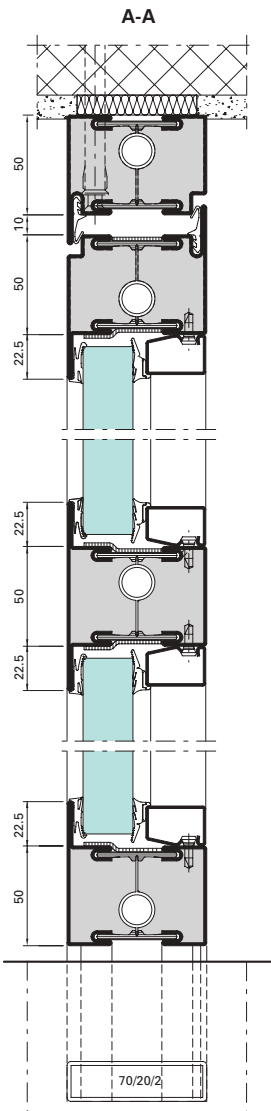
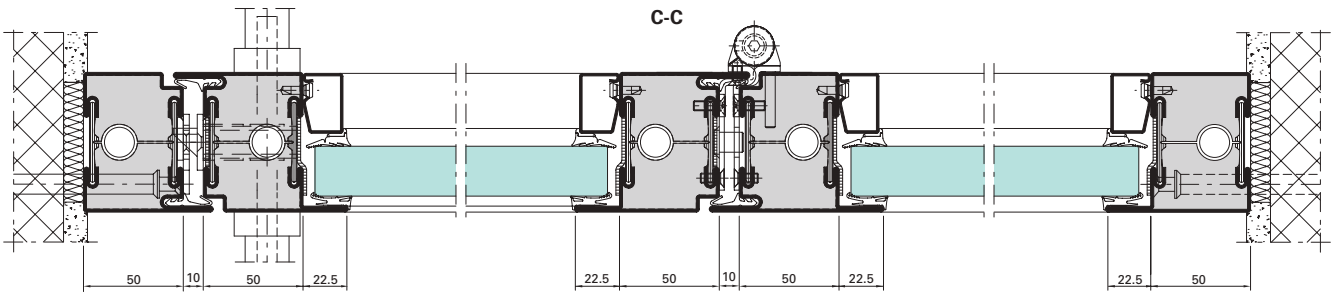

METALFORM

Example of Janisol C4 EI90

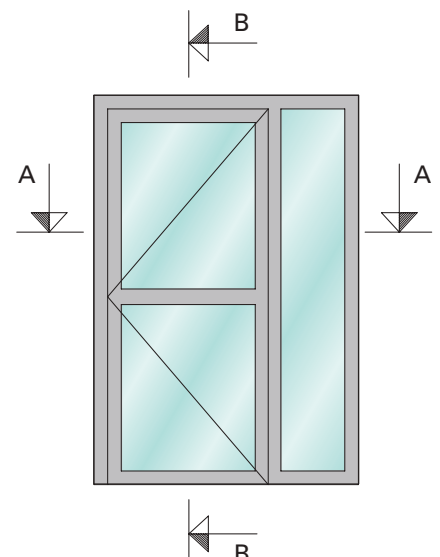
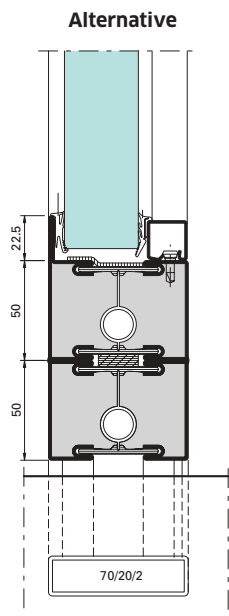
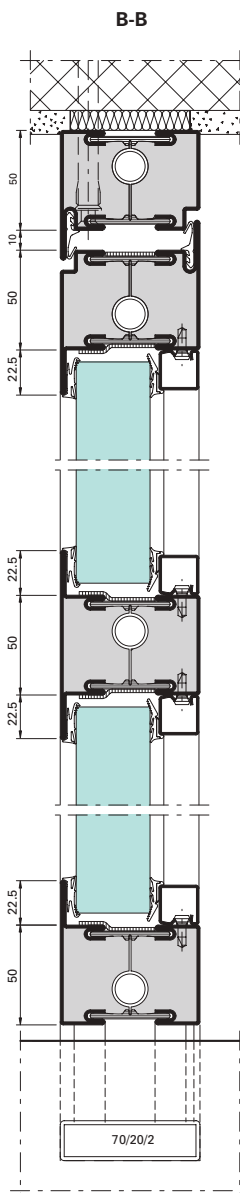
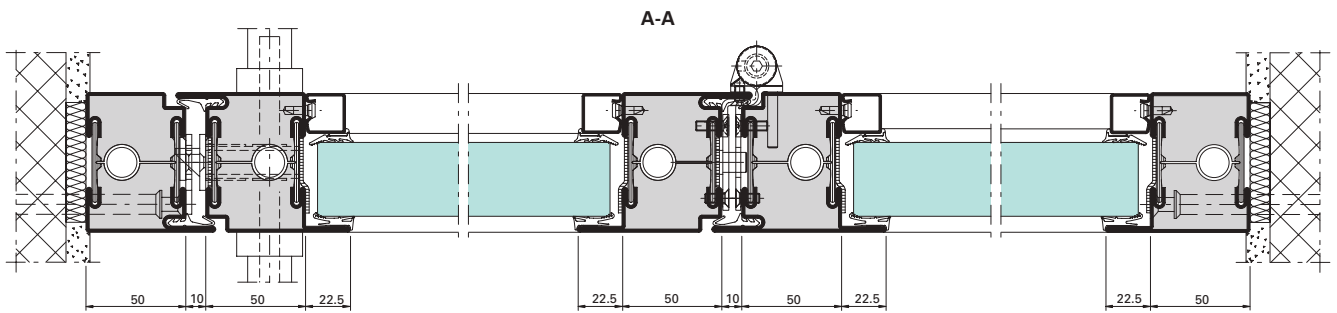

Profile range

Janisol C4 EI60 / EI90

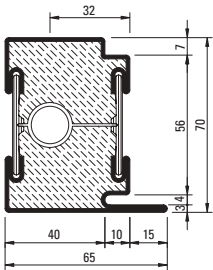

630.013.C4
630.013.C4 Z
630.013.C41

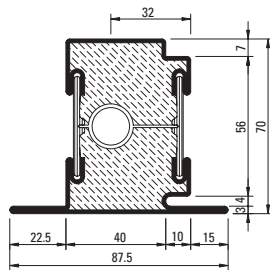

630.114.C4
630.114.C4 Z
630.114.C41

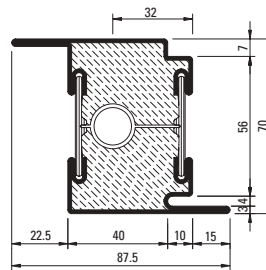

630.416.C4
630.416.C4 Z
630.416.C41

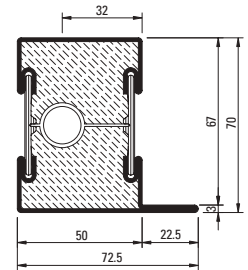

601.685.C4
601.685.C4 Z
601.685.C41

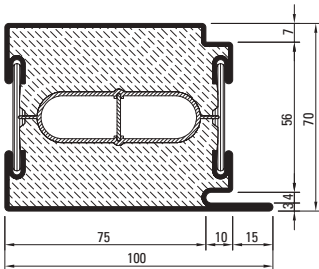

630.016.C4
630.016.C4 Z

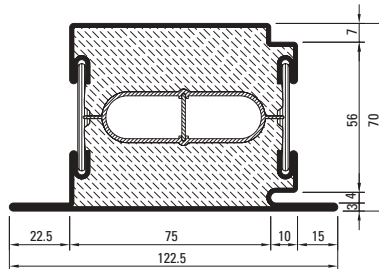

630.115.C4
630.115.C4 Z

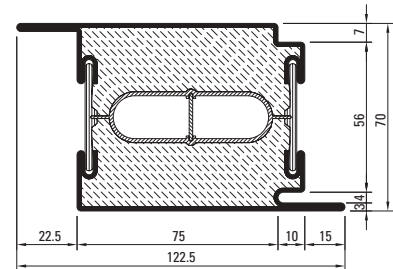

630.417.C4
630.417.C4 Z

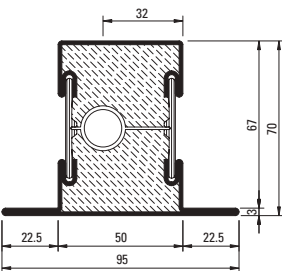

602.685.C4
602.685.C4 Z
602.685.C41

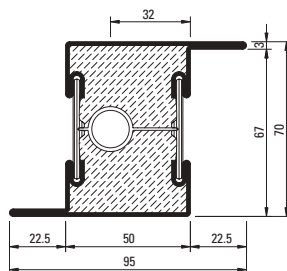

603.685.C4
603.685.C4 Z

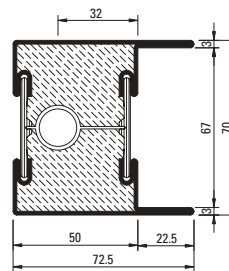

604.685.C4
604.685.C4 Z

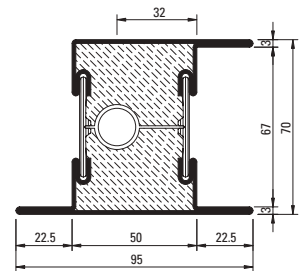

605.685.C4
605.685.C4 Z
605.685.C41

METALFORM

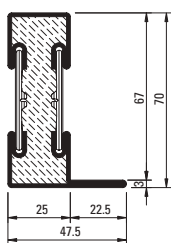

601.635.C4
601.635.C4 Z

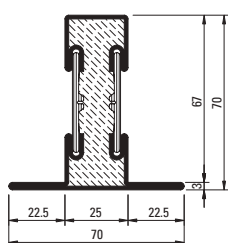

602.635.C4
602.635.C4 Z

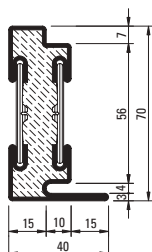

630.010.C4
630.010.C4 Z

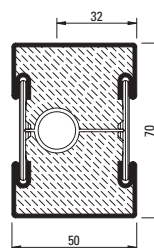

600.005.C4
600.005.C4 Z



600.006.C4
600.006.C4 Z

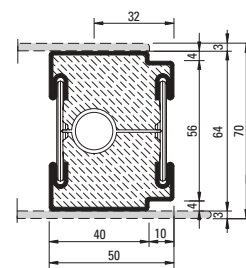

600.010.C4 Z

Z = strip galvanised steel

41 = Stainless steel, bright, Material 1.4401 (AISI 316)



Janisol 1

Fire-proof windows

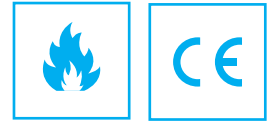

Full fire safety range

The Janisol 1 system for windows and fixed glazing as well as the systems for doors and fixed glazing round off the fire safety product range. The system meets fire resistance class E/EW45 for window applications as well as E/EW30 for fixed glazing. The window has an installation depth of 60 mm (window frame) or 64 mm (window casement) and has the same face as the Janisol window. It also impresses thanks to its simple and efficient processing.

Advantages

- Thermally insulated steel system for windows and fixed glazing
- Installation depth of 60 mm (window frame) or 64 mm (window casement)
- Narrow face width: Frame incl. leaf from 82.5 mm, secondary sash 103 mm
- Single- and double-leaf tilt and turn windows
- Tilt and turn window casement up to 1265 x 2300 mm
- Leaf weights: Standard fitting up to 150 kg
- Filling element thickness from 14 to 47 mm, glass can be installed used dry or wet glazing
- System tests in accordance with the EN 14351-1 and EN 16034 product standards
- Profile composite technology tested in accordance with EN 14024
- Suitable for powder and wet paint/varnish coatings



Example of Janisol 1 fire-proof windows

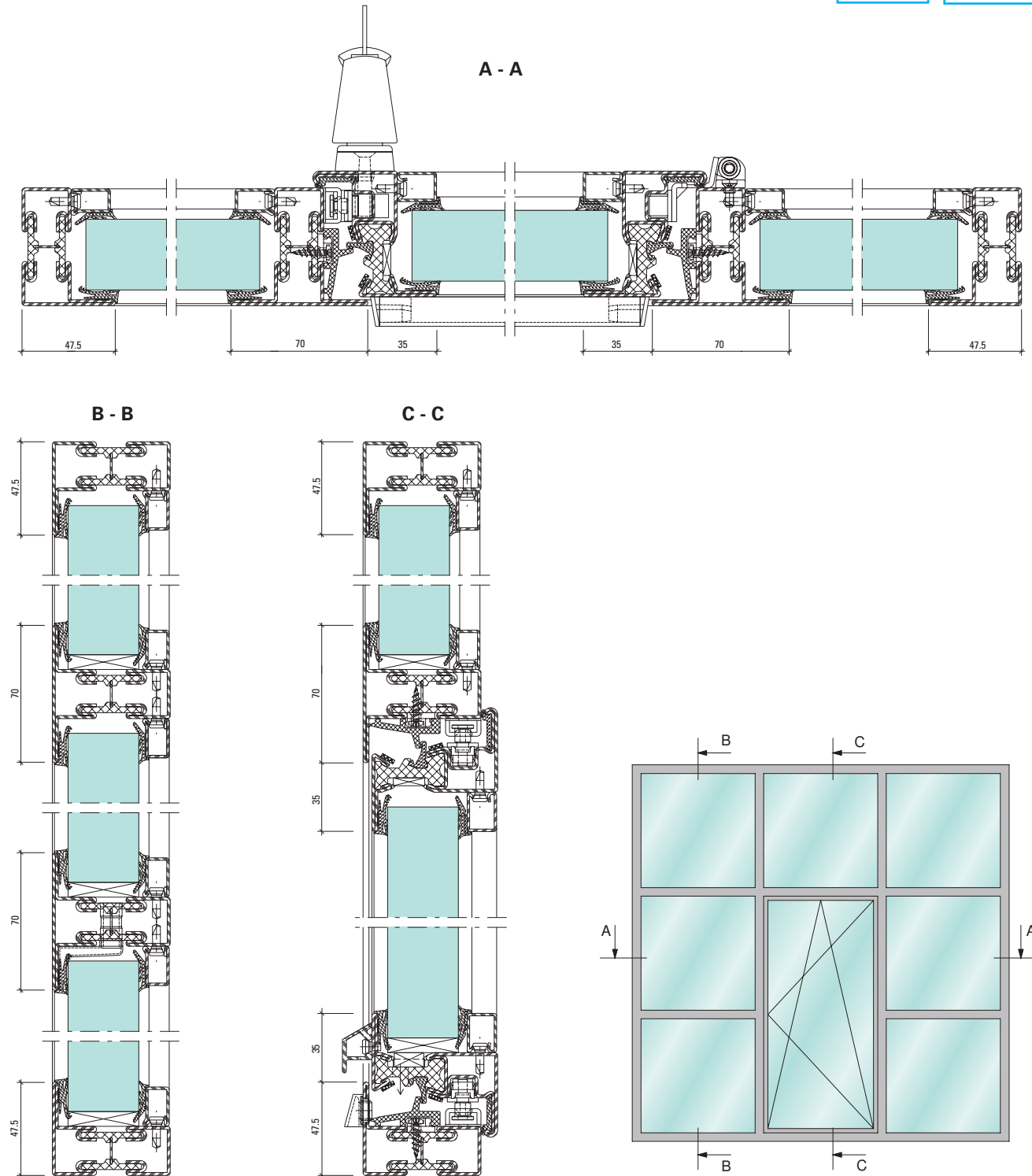

Glazing beads

Steel and aluminium

Steel glazing beads made of strip galvanised steel (length 6 m)

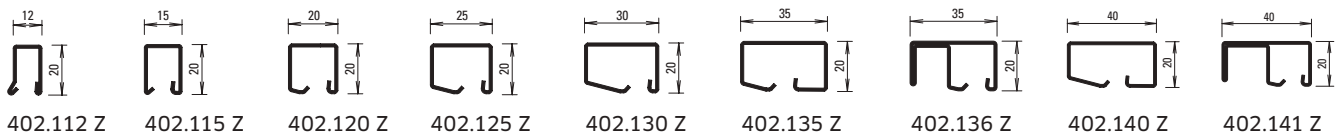

Stainless steel glazing beads (length 6 m)*

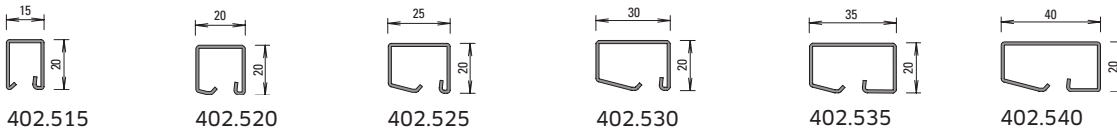

Angle contour steel glazing beads (length approx. 6 m)

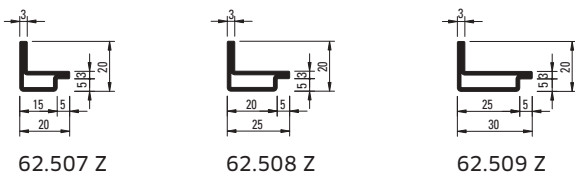

Aluminium glazing beads (length 6 m)*

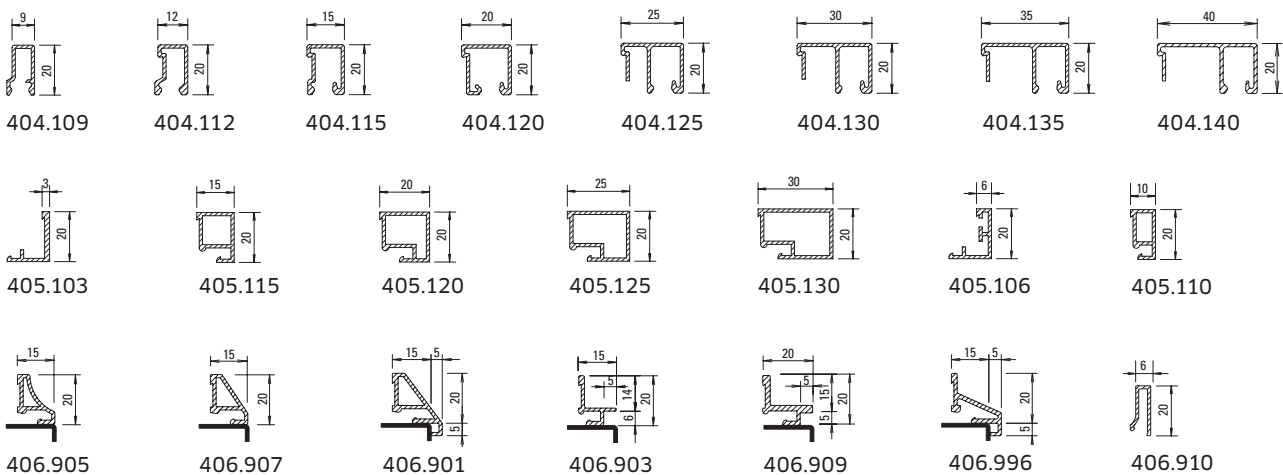

* Only permitted for smoke doors conforming to DIN 18095

METALFORM

System versatility: for every application



Non-insulated profile systems
made from steel and stainless steel

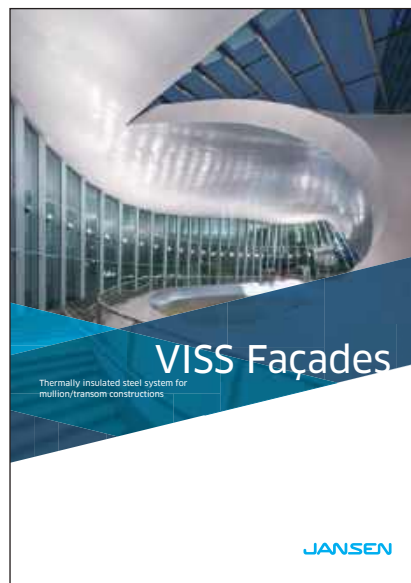

Thermally insulated steel system for
mullion/transom constructions

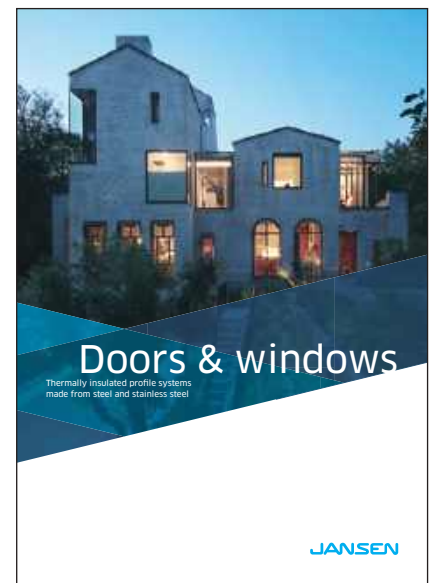

Thermally insulated profile systems
made from steel and stainless steel

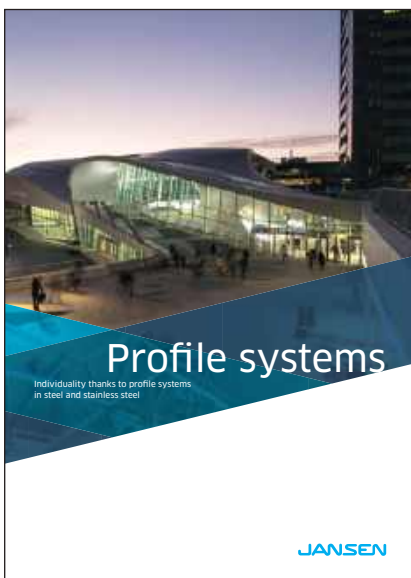

Individuality thanks to profile systems
in steel and stainless steel

You can find further brochures and
documentation in our download centre
at jansen.com.

If there are any differences between this document and the current German version (item number K1016991), the latest version of the original German text in the Jansen Docu Center shall prevail.

K1016986 | Steel Systems | 01.2021 | Subject to change

Jansen AG

Steel Systems
Industriestrasse 34
9463 Oberriet
Schweiz
jansen.com

JANSEN
METALFORM

METALFORM

MASTERS OF METAL

UNITED KINGDOM

METALFORM

NORWAYMETAL LTD

53 Chelsea Manor Street

London, SW3 5RZ

SALES@METALFORM.UK

+44 20 81298814

GERMANY

METALFORM GMBH

Carl-Zeiss-Ring 15A

85737 Ismaning

SALES@METALFORMGROUP.DE

+49 17663630406

NORWAY

METALFORM AS

Brochmannsveien 2

1950 Rømskog

SALG@METALFORM.NO

+47 401 62 446

METALFORMGROUP

SALES@METALFORMGROUP.COM